



RIGOL

RSA6000 Series

Real-Time Spectrum Analyzer

User Guide

Aug. 2025

Guaranty and Declaration

Copyright

© 2025 RIGOL TECHNOLOGIES CO., LTD. All Rights Reserved.

Trademark Information

RIGOL® is the trademark of RIGOL TECHNOLOGIES CO., LTD.

Notices

- RIGOL products are covered by P.R.C. and foreign patents, issued and pending.
- RIGOL reserves the right to modify or change parts of or all the specifications and pricing policies at the company's sole decision.
- Information in this publication replaces all previously released materials.
- Information in this publication is subject to change without notice.
- RIGOL shall not be liable for either incidental or consequential losses in connection with the furnishing, use, or performance of this manual, as well as any information contained.
- Any part of this document is forbidden to be copied, photocopied, or rearranged without prior written approval of RIGOL.

Product Certification

RIGOL guarantees that this product conforms to the national and industrial standards in China as well as the ISO9001:2015 standard and the ISO14001:2015 standard. Other international standard conformance certifications are in progress.

Contact Us

If you have any problem or requirement when using our products or this manual, please contact RIGOL.

E-mail: service@rigol.com

Website: <http://www.rigol.com>

Section	Description	Page
	List of Figures.....	IX
1	Safety Requirement	1
1.1	General Safety Summary	1
1.2	Safety Notices and Symbols	2
1.3	Measurement Category	3
1.4	Ventilation Requirement	4
1.5	Working Environment	4
1.6	Care and Cleaning	6
1.7	Environmental Considerations	6
2	Product Features	7
3	Document Overview	8
4	Quick Start	10
4.1	General Inspection	10
4.2	Appearance and Dimensions	11
4.3	To Prepare for Use	12
4.3.1	To Adjust the Supporting Legs	12
4.3.2	To Connect to AC Power	12
4.3.3	Turn-on Checkout	13
4.3.4	To Perform Self-calibration	13
4.3.5	To Set the System Language	13
4.4	Product Overview	13
4.4.1	Front Panel	14
4.4.1.1	Function Keys on the Front Panel	16
4.4.1.2	Front Panel Key Backlight	17
4.4.1.3	Front Panel Connector	18
4.4.1.4	To Use the Numeric Keypad	19
4.4.2	Rear Panel	21
4.4.3	User Interface	23
4.5	Mouse/Keypad Board/Touch Screen Operation Rule	24
4.5.1	Mouse Operation Rule	24
4.5.2	Keypad Board Operation Rule	25
4.5.3	Touch Screen Operation Rule	26
4.6	Menu Operation	27

4.7	Parameter Setting	28
4.8	To Use the Built-in Help System	30
4.9	To Replace the Fuse	30
4.10	To View the Option and the Option Installation	31
4.11	Mode Setting	32
4.11.1	Mode	32
5	Functions of the Front Panel of GPSA	33
5.1	Basic Settings	33
5.1.1	Freq	33
5.1.1.1	Center Frequency	33
5.1.1.2	Start Freq	34
5.1.1.3	Stop Freq	35
5.1.1.4	Freq Offset	36
5.1.1.5	CF Step	37
5.1.1.6	CF Step Mode	37
5.1.1.7	Signal Track	38
5.1.1.8	X-axis Scale Type	38
5.1.1.9	Span	39
5.1.1.10	Last Span	40
5.1.1.11	Full Span	40
5.1.1.12	Zero Span	40
5.1.2	Display	40
5.1.2.1	Display Setting	40
5.1.3	Ampt	42
5.1.3.1	Reference Level	42
5.1.3.2	Attenuation	43
5.1.3.3	Attenuation Mode	44
5.1.3.4	Preamplifier	44
5.1.3.5	Y Axis Unit	44
5.1.3.6	Y-axis Scale Type	45
5.1.3.7	Scale/Div	45
5.1.3.8	Max Mixer Level	46
5.1.3.9	Ref Offset	47
5.2	Sweep and Function Settings	47
5.2.1	Bandwidth	47
5.2.1.1	Resolution Bandwidth (RBW)	47
5.2.1.2	RBW Mode	48

5.2.1.3	Span/RBW Ratio	48
5.2.1.4	Span/RBW Mode	49
5.2.1.5	Video Bandwidth	49
5.2.1.6	VBW Mode	50
5.2.1.7	VBW/RBW Ratio	50
5.2.1.8	VBW/RBW Mode	50
5.2.1.9	Filter Type	51
5.2.1.10	Auto Couple	51
5.2.2	Sweep	51
5.2.2.1	Sweep Points	51
5.2.2.2	Sweep Time	52
5.2.2.3	Sweep Time Mode	53
5.2.2.4	Sweep Time Rules	53
5.2.2.5	Sweep Type	53
5.2.2.6	Sweep Type Mode	53
5.2.2.7	Sweep Mode	53
5.2.2.8	Restart	54
5.2.3	Trigger	55
5.2.3.1	Trigger Source	55
5.2.3.2	Slope	55
5.2.3.3	Delay State	55
5.2.3.4	Delay Time	55
5.2.3.5	Trigger Level	56
5.2.3.6	Trigger Holdoff State	56
5.2.3.7	Trigger Holdoff	57
5.2.3.8	Auto Trig Switch	57
5.2.3.9	Auto Trig	57
5.2.4	Trace	58
5.2.4.1	Selected Trace	58
5.2.4.2	Trace Type	58
5.2.4.3	Detector Type	59
5.2.4.4	Detector Auto	61
5.2.4.5	Trace Update	61
5.2.4.6	Trace Display	61
5.2.4.7	Math Function	62
5.2.4.8	Op1	63
5.2.4.9	Op2	63

5.2.4.10	Offset	63
5.2.4.11	Reference	64
5.2.4.12	Preset All	64
5.2.4.13	Clear All Traces	64
5.2.5	TG (Option)	64
5.2.5.1	TG	65
5.2.5.2	Amplitude	65
5.2.5.3	Amplitude Offset	66
5.2.5.4	Normalize	66
5.3	Measurement Settings	68
5.3.1	Meas Setup	68
5.3.1.1	Swept SA Measurement	68
5.3.1.2	ACP	73
5.3.1.3	C/N Ratio (CNR)	76
5.3.1.4	Channel Power	79
5.3.1.5	Third-order Intercept (TOI)	81
5.3.1.6	Harmo Dist (THD)	84
5.3.1.7	OBW	86
5.3.1.8	Time-domain Power (T-Power)	89
5.4	Marker Measurement	92
5.4.1	Marker Setting	92
5.4.1.1	Selected Marker	93
5.4.1.2	Next Marker	93
5.4.1.3	Marker Mode	93
5.4.1.4	Reference Marker	95
5.4.1.5	Marker Trace	95
5.4.1.6	Marker Trace Auto	95
5.4.1.7	Marker Frequency/Time	95
5.4.1.8	Marker Amplitude	96
5.4.1.9	Marker Readout	96
5.4.1.10	Readout Auto	97
5.4.1.11	Line State	97
5.4.1.12	Couple Markers	98
5.4.1.13	Marker Table	98
5.4.1.14	All Markers Off	99
5.4.2	Marker To	99
5.4.2.1	Mkr->CF	99

5.4.2.2	Mkr->CF Step	99
5.4.2.3	Mkr->Start	99
5.4.2.4	Mkr->Stop	100
5.4.2.5	Mkr->Ref	100
5.4.2.6	Marker Δ ->CF	100
5.4.2.7	Mkr Δ ->Span	100
5.4.3	Marker Function	100
5.4.3.1	N dB State	101
5.4.3.2	N dB Bandwidth	101
5.4.3.3	Band Function	102
5.4.3.4	Band Adjustment	102
5.4.3.5	Marker Counter	103
5.4.3.6	Gate Time	103
5.4.3.7	Gate Time Auto	103
5.4.4	Peak Search	104
5.4.4.1	Peak Search	104
5.4.4.2	Next Peak	104
5.4.4.3	Next Peak Right	104
5.4.4.4	Next Peak Left	104
5.4.4.5	Minimum Search	104
5.4.4.6	Pk-Pk Search	105
5.4.4.7	Continuous Peak	105
5.4.4.8	Cont Peak Min	105
5.4.4.9	Peak Table	105
5.4.4.10	Peak Table Sort	106
5.4.4.11	Peak Table Readout	106
5.4.4.12	Display Line	107
5.4.5	Peak Config	107
6	Functions of the Front Panel of RTSA	110
6.1	Basic Settings	110
6.1.1	Freq	110
6.1.1.1	Span	111
6.1.1.2	Last Span	111
6.1.1.3	Full Span	111
6.1.1.4	Ref Time (PvT)	112
6.1.1.5	X-Scale (PvT)	112
6.1.1.6	Ref Position (PvT)	112

6.1.1.7	Auto Scale (PvT)	113
6.1.2	Display	113
6.1.2.1	Normal	114
6.1.2.2	Spectrogram	115
6.1.2.3	Density	118
6.1.2.4	Density/Spectrogram	122
6.1.2.5	PvT	123
6.1.2.6	PvT/Normal	124
6.1.2.7	PvT/Normal/Spectrogram	125
6.1.3	Ampt	125
6.2	Sweep and Function Settings	126
6.2.1	BW	126
6.2.1.1	Resolution Bandwidth (RBW)	126
6.2.1.2	RBW Mode	127
6.2.1.3	Filter Type	127
6.2.2	Sweep	127
6.2.2.1	Capture Time	128
6.2.2.2	Acq Mode	128
6.2.2.3	Acq Time PvT	128
6.2.2.4	Acq Time PvT Auto	129
6.2.2.5	Sweep Mode	129
6.2.2.6	Restart	129
6.2.3	Trigger	129
6.2.3.1	Acquisition Times	129
6.2.3.2	IF Power	130
6.2.3.3	FMT	130
6.2.4	Trace	133
6.2.4.1	Detector Type	134
6.3	Measurement Settings	134
6.3.1	Meas Setup	134
6.3.1.1	Avg Number	134
6.3.1.2	Limit	134
6.3.1.3	Global CF Mode	135
6.4	Marker Setting	135
6.4.1	Marker	135
6.4.1.1	Marker Trace	135
6.4.1.2	Marker Z	135

6.4.2	Marker To	136
6.4.3	Marker Function	136
6.4.4	Peak	136
7	Input/Output	137
7.1	Input Impedance	137
7.2	Ext Gain	137
7.3	Trig Out	137
7.4	Amplitude Correction	138
8	Shortcut Key	139
8.1	Auto	139
8.2	Preset	139
8.3	Single/Continue	150
8.4	Restart	150
9	System Function	151
9.1	System	151
9.1.1	I/O Setting	151
9.1.2	Basic Settings	153
9.1.3	About this Spectrum	154
9.1.4	Options	155
9.1.5	Calibration	155
9.2	File	156
9.2.1	File Management	156
9.2.2	Copy	156
9.2.3	Cut	157
9.2.4	Paste	157
9.2.5	Rename	157
9.2.6	Delete	157
9.2.7	New Folder	157
9.2.8	Safe Clear	157
9.3	Recall	157
9.3.1	State	157
9.3.2	Trace & State	158
9.3.3	Measurement Data	158
9.3.4	Limit	158
9.3.5	FMT (only available for RTSA)	159
9.3.6	Amplitude Correction	159
9.4	Save	159

9.4.1 State	159
9.4.2 Preset	159
9.4.3 Trace & State	160
9.4.4 Measurement Data	160
9.4.5 Limit	160
9.4.6 FMT (only available for RTSA)	161
9.4.7 Amplitude Correction	161
9.4.8 Screen Image	161
9.5 Update	162
9.6 Help Menu	162
9.7 Shutdown	162
9.8 Restart	162
9.9 Auto	163
10 Remote Control	164
10.1 Remote Control via USB	164
10.2 Remote Control via LAN	165
11 Troubleshooting	167
12 Appendix	168
12.1 Appendix A: Options and Accessories	168
12.2 Appendix B: Warranty	169
Index.....	170

List of Figures

Figure 4.1 Front view (mm)	11
Figure 4.2 Side view (mm)	11
Figure 4.3 Adjust the Supporting Legs	12
Figure 4.4 Front Panel	14
Figure 4.5 Function Keys	16
Figure 4.6 Front Panel Connector	18
Figure 4.7 Numeric Keypad	19
Figure 4.8 Rear Panel	21
Figure 4.9 User Interface	23
Figure 4.10 Knob	28
Figure 4.11 Arrow Keys	29
Figure 4.12 Replace the Fuse	30
Figure 5.1 Relationship of Trigger Parameters	58
Figure 5.2 Measurement Setting Interface	65
Figure 5.3 ACP Measurement Interface	73
Figure 5.4 C/N Ratio Measurement Interface	76
Figure 5.5 Channel Power Measurement Interface	79
Figure 5.6 TOI Distortion Measurement Interface	82
Figure 5.7 Harmonic Distortion Measurement Interface	84
Figure 5.8 OBW Measurement Interface	86
Figure 5.9 T-Power Measurement Interface	90
Figure 5.10 Marker	93
Figure 5.11 Marker Table	98
Figure 5.12 N dB Bandwidth Measurement	101
Figure 5.13 Peak Table	106
Figure 6.1 Normal View	114
Figure 6.2 Spectrogram View	115

Figure 6.3 Density Display View	118
Figure 6.4 Density/Waterfall Plot View	122
Figure 6.5 PvT View	123
Figure 6.6 PvT/Normal View	124
Figure 6.7 PvT/Normal/Waterfall Plot View	125
Figure 6.8 FMT Editing Interface	132

1 Safety Requirement

1.1 General Safety Summary

Please review the following safety precautions carefully before putting the instrument into operation so as to avoid any personal injury or damage to the instrument and any product connected to it. To prevent potential hazards, please follow the instructions specified in this manual to use the instrument properly.

- **Use Proper Power Cord.**

Only the exclusive power cord designed for the instrument and authorized for use within the local country could be used.

- **Ground the Instrument.**

The instrument is grounded through the Protective Earth lead of the power cord. To avoid electric shock, it is essential to connect the earth terminal of the power cord to the Protective Earth terminal before connecting any inputs or outputs.

- **Observe All Terminal Ratings.**

To avoid fire or shock hazard, observe all ratings and markers on the instrument and check your manual for more information about ratings before connecting the instrument.

- **Use Proper Overvoltage Protection.**

Ensure that no overvoltage (such as that caused by a bolt of lightning) can reach the product. Otherwise, the operator might be exposed to the danger of an electric shock.

- **Do Not Operate Without Covers.**

Do not operate the instrument with covers or panels removed.

- **Do Not Insert Objects Into the Air Outlet.**

Do not insert anything into the holes of the fan to avoid damaging the instrument.

- **Use Proper Fuse.**

Please use the specified fuses.

- **Avoid Circuit or Wire Exposure.**

Do not touch exposed junctions and components when the unit is powered on.

- **Do Not Operate With Suspected Failures.**

If you suspect damage occurs to the instrument, have it inspected by RIGOL authorized personnel before further operations. Any maintenance, adjustment or

replacement especially to circuits or accessories must be performed by RIGOL authorized personnel.

- **Provide Adequate Ventilation.**

Inadequate ventilation may cause an increase of temperature in the instrument, which would cause damage to the instrument. So please keep the instrument well ventilated and inspect the air outlet and the fan regularly.

- **Do Not Operate in Wet Conditions.**

To avoid short circuit inside the instrument or electric shock, never operate the instrument in a humid environment.

- **Do Not Operate in an Explosive Atmosphere.**

To avoid personal injuries or damage to the instrument, never operate the instrument in an explosive atmosphere.

- **Keep Instrument Surfaces Clean and Dry.**

To avoid dust or moisture from affecting the performance of the instrument, keep the surfaces of the instrument clean and dry.

- **Prevent Electrostatic Impact.**

Operate the instrument in an electrostatic discharge protective environment to avoid damage induced by static discharges. Always ground both the internal and external conductors of cables to release static before making connections.

- **Use the Battery Properly.**

Do not expose the battery (if available) to high temperature or fire. Keep it out of the reach of children. Improper change of a battery (lithium battery) may cause an explosion. Use the RIGOL specified battery only.

- **Handle with Caution.**

Please handle with care during transportation to avoid damage to keys, knobs, interfaces, and other parts on the panels.



WARNING

Equipment meeting Class A requirements may not offer adequate protection to broadcast services within residential environment.

1.2 Safety Notices and Symbols

Safety Notices in this Manual:



WARNING

Indicates a potentially hazardous situation or practice which, if not avoided, will result in serious injury or death.



CAUTION

Indicates a potentially hazardous situation or practice which, if not avoided, could result in damage to the product or loss of important data.

Safety Notices on the Product:

- **DANGER**
It calls attention to an operation, if not correctly performed, could result in injury or hazard immediately.
- **WARNING**
It calls attention to an operation, if not correctly performed, could result in potential injury or hazard.
- **CAUTION**
It calls attention to an operation, if not correctly performed, could result in damage to the product or other devices connected to the product.

Safety Symbols on the Product:



Hazardous
Voltage



Safety Warning



Protective Earth
Terminal



Chassis Ground



Test Ground

1.3 Measurement Category

Measurement Category

This instrument can make measurements in Measurement Category I.



WARNING

This instrument can only be used for measurements within its specified measurement categories.

Measurement Category Definitions

- **Measurement category I** is for measurements performed on circuits not directly connected to MAINS. Examples are measurements on circuits not derived from MAINS, and specially protected (internal) MAINS derived circuits. In the latter case, transient stresses are variable. Thus, you must know the transient withstand capability of the equipment.
- **Measurement category II** is for measurements performed on circuits directly connected to low voltage installation. Examples are measurements on household appliances, portable tools and similar equipment.

- **Measurement category III** is for measurements performed in the building installation. Examples are measurements on distribution boards, circuit-breakers, wiring (including cables, bus-bars, junction boxes, switches and socket-outlets) in the fixed installation, and equipment for industrial use and some other equipment. For example, stationary motors with permanent connection to a fixed installation.
- **Measurement category IV** is for measurements performed at the source of a low-voltage installation. Examples are electricity meters and measurements on primary overcurrent protection devices and ripple control units.

1.4 Ventilation Requirement

This instrument uses a fan to force cooling. Please make sure that the air inlet and outlet areas are free from obstructions and have free air. When using the instrument in a bench-top or rack setting, provide at least 10 cm clearance beside, above and behind the instrument for adequate ventilation.



CAUTION

Inadequate ventilation may cause an increase of temperature in the instrument, which would cause damage to the instrument. So please keep the instrument well ventilated and inspect the air outlet and the fan regularly.

1.5 Working Environment

Temperature

Operating: 0°C to +50°C

Non-operating: -20°C to +70°C

Humidity

- **Operating:**

Below +30°C: ≤95% RH (without condensation)

+30°C to +40°C: ≤75% RH (without condensation)

+40°C to +50°C: ≤45% RH (without condensation)

- **Non-operating:**

Below +40°C: 5%~ 90% (without condensation)

≥+40°C to <+60°C: 5%~ 80% (without condensation)

>+60°C to <+70°C: 5%~ 40% (without condensation)



WARNING

To avoid short circuit inside the instrument or electric shock, never operate the instrument in a humid environment.

Altitude

Operating: below 3 km

Protection Level Against Electric Shock

- **Contact discharge:** ±4 kV
- **Air discharge:** ±8 kV

Installation (Overvoltage) Category

This product is powered by mains conforming to installation (overvoltage) category II.



WARNING

Ensure that no overvoltage (such as that caused by a bolt of lightning) can reach the product. Otherwise, the operator might be exposed to the danger of an electric shock.

Installation (Overvoltage) Category Definitions

Installation (overvoltage) category I refers to signal level which is applicable to equipment measurement terminals connected to the source circuit. Among these terminals, precautions are done to limit the transient voltage to a low level.

Installation (overvoltage) category II refers to the local power distribution level which is applicable to equipment connected to the AC line (AC power).

Pollution Degree

Pollution Degree 2

Pollution Degree Definition

- **Pollution Degree 1:** No pollution or only dry, nonconductive pollution occurs. The pollution has no effect. For example, a clean room or air-conditioned office environment.
- **Pollution Degree 2:** Normally only nonconductive pollution occurs. Temporary conductivity caused by condensation is to be expected. For example, indoor environment.
- **Pollution Degree 3:** Conductive pollution or dry nonconductive pollution that becomes conductive due to condensation occurs. For example, sheltered outdoor environment.
- **Pollution Degree 4:** The pollution generates persistent conductivity caused by conductive dust, rain, or snow. For example, outdoor areas.

Safety Class

Class 1 – Grounded Product

1.6 Care and Cleaning

Care

Do not store or leave the instrument where it may be exposed to direct sunlight for long periods of time.

Cleaning

Clean the instrument regularly according to its operating conditions.

1. Disconnect the instrument from all power sources.
2. Clean the external surfaces of the instrument with a soft cloth dampened with mild detergent or water. Avoid having any water or other objects into the chassis via the heat dissipation hole. When cleaning the LCD, take care to avoid scarifying it.

CAUTION

To avoid damage to the instrument, do not expose it to caustic liquids.

WARNING

To avoid short-circuit resulting from moisture or personal injuries, ensure that the instrument is completely dry before connecting it to the power supply.

1.7 Environmental Considerations

The following symbol indicates that this product complies with the WEEE Directive 2012/19/EU.



The equipment may contain substances that could be harmful to the environment or human health. To avoid the release of such substances into the environment and avoid harm to human health, we recommend you to recycle this product appropriately to ensure that most materials are reused or recycled properly. Please contact your local authorities for disposal or recycling information.

You can click on the following link <https://int.rigol.com/services/services/declaration> to download the latest version of the RoHS&WEEE certification file.

2 Product Features

Product Features

- Five working modes: GPSA, RTSA, VSA, EMI, and ADM
- Frequency range: 5 kHz to 26.5 GHz
- Excellent DANL (Displayed Average Noise Level)
- Good phase noise performance
- High-precision amplitude measurement error
- Multiple analysis bandwidth options
- Excellent SFDR
- Powerful real-time spectrum analysis function
- Display different types of measurement values in multi-pane windowing form
- Support USB, LAN, and HDMI interfaces
- Support standard SCPI instruction sets

RSA6000 series is RIGOL's newly launched spectrum analyzer product. Its excellent performance in SFDR, phase noise, amplitude accuracy and test speed makes it applicable in various test scenarios such as spectrum analysis, real-time spectrum analysis, vector signal analysis, pulse analysis. RSA6000 series real-time spectrum analyzer has a strong expansion capability, allowing you to build the test system or perform user-defined development via various digital and analog output interfaces. With its excellent performance and flexible configuration, it can meet your test demands in various application scenarios such as wireless communication, automobile electronics, Internet of Things (IoT), and etc.

3 Document Overview

This manual gives you a quick review about the front and rear panel of RSA6000 series, the user interface, and its basic operation method.



TIP

For the latest version of this manual, download it from the official website of RIGOL (<http://www.rigol.com>).

Publication Number

UGD27100-1110

Software Version

00.00.11

Software upgrade might change or add product features. Please acquire the latest version of the manual from RIGOL website or contact RIGOL to upgrade the software.

Format Conventions in this Manual

1. Key

The front panel key is denoted by the menu key icon. For example,  indicates the "System" key.

2. Menu

The menu item is denoted by the format of "Menu Name (Bold) + Character Shading" in the manual. For example, **Setup** indicates clicking or tapping the "Setup" sub-menu under the "System" menu to view the basic system settings.

3. Operation Procedures

The next step of the operation is denoted by ">" in the manual. For example, 

> **Save** indicates that first clicking or tapping the icon , then clicking or tapping **Save**.

4. Connector

The connectors on the front or rear panel are usually denoted by the format of "Connector Name (Bold) + Square Brackets (Bold)". For example **[TRIG IN]**.

Content Conventions in this Manual

The RSA6000 series spectrum analyzer includes the following models. Unless otherwise specified, this manual takes RSA6265 as an example to illustrate the functions and operation methods of the RSA6000 series.

Model	Frequency Range
RSA6265	5 kHz to 26.5 GHz
RSA6140	5 kHz to 14 GHz
RSA6085	5 kHz to 8.5 GHz

4 Quick Start

4.1 General Inspection

1. Inspect the packaging

If the packaging has been damaged, do not dispose the damaged packaging or cushioning materials until the shipment has been checked for completeness and has passed both electrical and mechanical tests.

The consigner or carrier shall be liable for the damage to the instrument resulting from shipment. RIGOL would not be responsible for free maintenance/rework or replacement of the instrument.

2. Inspect the instrument

In case of any mechanical damage, missing parts, or failure in passing the electrical and mechanical tests, contact your RIGOL sales representative.

3. Check the accessories

Please check the accessories according to the packing lists. If the accessories are damaged or incomplete, please contact your RIGOL sales representative.

Recommended Calibration Interval

RIGOL suggests that the instrument should be calibrated every 18 months.

4.2 Appearance and Dimensions

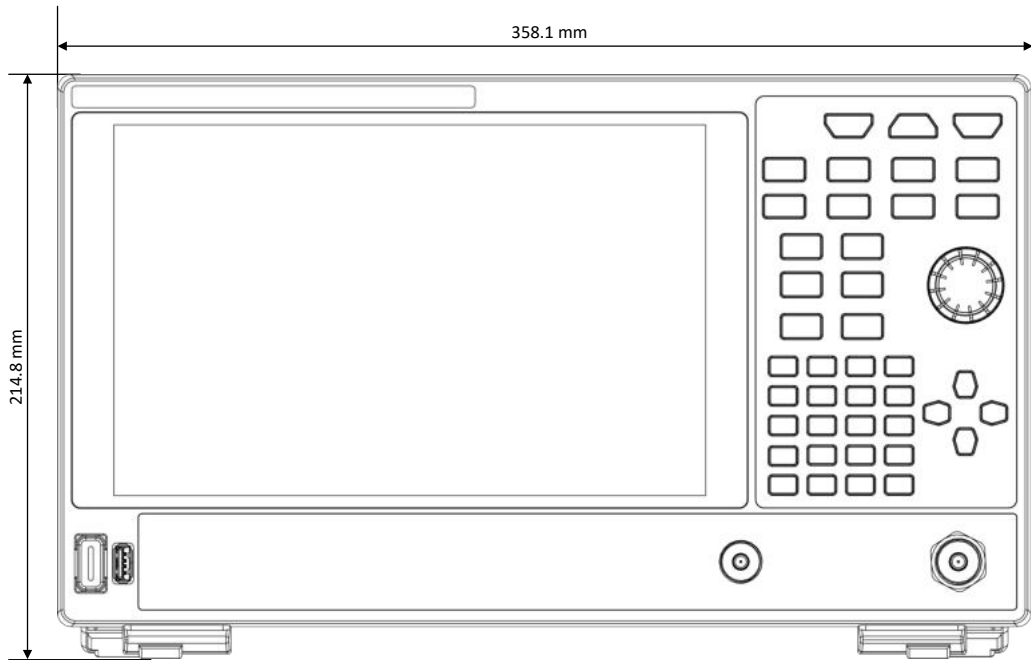

Figure 4.1 Front view (mm)

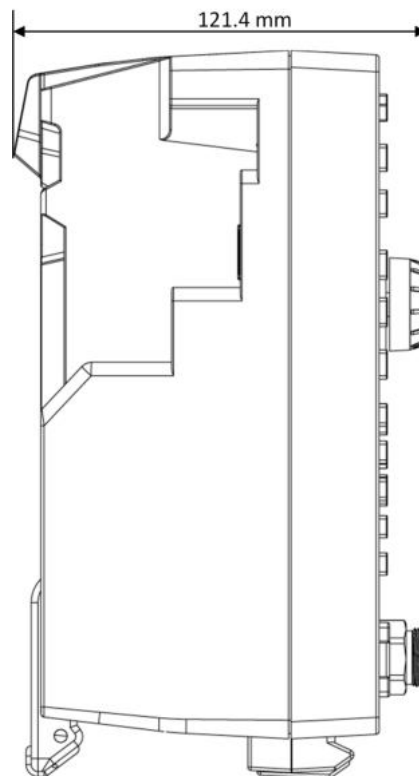

Figure 4.2 Side view (mm)

4.3 To Prepare for Use

4.3.1 To Adjust the Supporting Legs

You can unfold the supporting legs to use them as stands to tilt the instrument upwards for easier operation and observation. You can also fold the supporting legs when the instrument is not in use for easier storage or shipment.

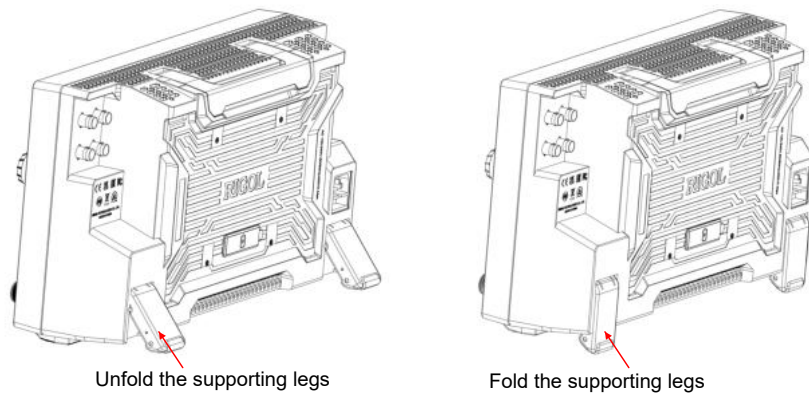
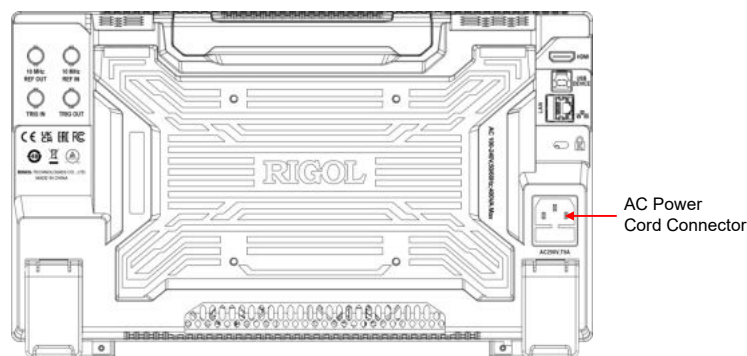

Figure 4.3 Adjust the Supporting Legs

4.3.2 To Connect to AC Power

Please use the power cord provided in the accessories to connect the spectrum analyzer to the AC power source. The AC power supply specification of this spectrum analyzer is 100-240 V, 50/60 Hz. The power consumption of the instrument cannot exceed 85 W. When the spectrum analyzer is connected to the AC power source via the power cord, the instrument automatically adjusts itself to within the proper voltage range, and you do not need to select the voltage range manually.



CAUTION

To avoid electric shock, ensure that the instrument is correctly grounded.



4.3.3 Turn-on Checkout

After connecting the instrument to the power source properly, press  on the front panel to start the spectrum analyzer. Then, you will see an initial splash screen. Following the start-up screen which shows the start-up initialization process information, the sweep curve is displayed.

4.3.4 To Perform Self-calibration

After the instrument starts, execute self-calibration.

Click or tap  > **Calibration** > **Calibrate Now**, and then the instrument will perform self-calibration with the internal calibration source.

4.3.5 To Set the System Language

This series supports multiple system languages. To select the desired language, click or tap  > **System** > **Setup** > **Language**.

4.4 Product Overview

RSA6000 series is RIGOL's newly launched spectrum analyzer product. Its excellent performance in SFDR, phase noise, amplitude accuracy and test speed makes it applicable in various test scenarios such as spectrum analysis, real-time spectrum analysis, vector signal analysis, pulse analysis. RSA6000 series real-time spectrum analyzer has a strong expansion capability, allowing you to build the test system or perform user-defined development via various digital and analog output interfaces. With its excellent performance and flexible configuration, it can meet your test demands in various application scenarios such as wireless communication, automobile electronics, Internet of Things (IoT), and etc.

4.4.1 Front Panel

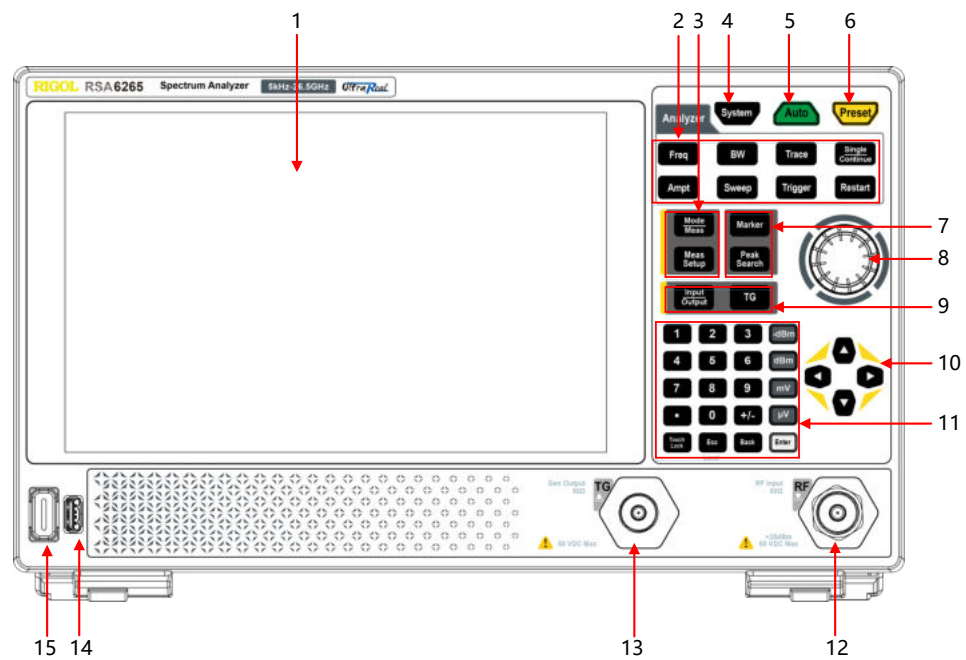

Figure 4.4 Front Panel

1. LCD

10.1" high-definition touch screen. Displays the measurement values such as the current trace, center frequency, and span in multi-pane windows.

2. Measurement Function Keys

Indicate the basic measurement functions. Press the specified key to enter the specified measurement.

3. Mode Setting

Sets the working mode and parameters of the specified mode.

4. System Key

Sets the system parameters.

5. Auto Setting

Searches for signals automatically within full frequency range.

6. Preset

Restores the instrument to its default settings.

7. Marker and Peak Search

Sets the marker parameters and performs peak search.

8. Knob

When the parameter is in editing mode, rotate the knob clockwise to increase or counterclockwise to decrease the parameter value at the specified step.

9. Function Key

- **Input/Output:** Sets the parameters such as input impedance, external gain, and external trigger 2. You can also select the desired RF calibration signal.
- **TG:** Sets the parameters related to the tracking generator (TG).

10. Arrow keys

Used to modify parameter values and moving the focus of menu items.

When the parameter is editable, use the arrow keys to increase or decrease the parameter value at the specific step. Note that the step sizes for the Up/Down arrow key and the Left/Right arrow key are different.

11. Numeric Keypad

You can use the numeric keypad to input numbers and common symbols (including decimal point, space, and +/- signs) when you set parameters.

12. RF Input 50Ω

Indicates the input connector of the signal under test. The DUT can be connected to the **[RF Input 50Ω]** connector via a cable with a N-type female connector (available for RSA6085 and RSA6140) or a cable with a 3.5mm male connector (available for RSA6265).

13. Gen Output 50Ω

Used to be connected to a receiver through the N-type male cable to output the signal of the tracking generator.

14. USB HOST Interface

Used to connect the analyzer that serves as a "master" device to the external USB storage device. The USB storage device, mouse, and keypad board can be connected to the instrument via this interface.

15. Power Key

Press this key to power on or off the instrument.

4.4.1.1 Function Keys on the Front Panel

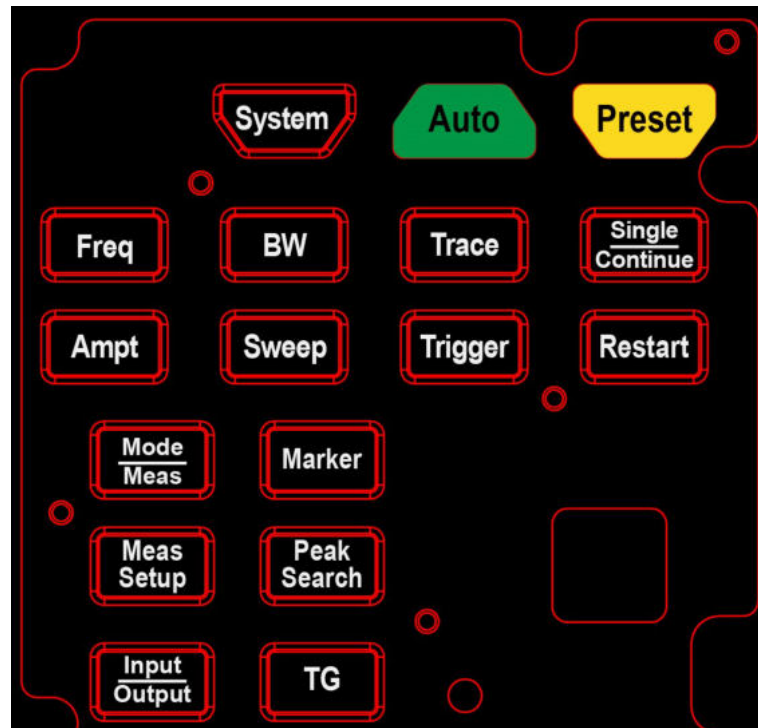

















Figure 4.5 Function Keys

Function Key	Description
	Sets the parameters such as center frequency, start frequency, stop frequency, and span; enables the signal tracking function.
	Sets the parameters such as reference level, RF attenuator, scale, and Y-axis unit. Enables preamp.
	Sets the parameters such as resolution bandwidth (RBW) and video bandwidth (VBW).
	Sets the parameters such as input impedance, external gain, and trigger output. Selects the RF calibration signal.
	Reads the amplitude and frequency of a certain point on the trace via marker.
	Opens the peak search menu and searches for peaks immediately.
	Sets the parameters related to trace.
	Sets the parameters related to the tracking generator (TG).

Function Key	Description
	Sets the sweep parameters.
	Sets the sweep mode to Single or Continuous.
	Sets the trigger source and its related parameters.
	Selects the working mode of the spectrum analyzer; selects and controls the measurement function.
	Sets the parameters for the selected measurement function.
	Searches for signals automatically within full frequency range.
	Restores the system to factory settings or user-defined state.
	Sets the system parameters.

**TIP**

Click or tap the drop-down button of menu operation control area at the right part of touch screen, and then the function menus that correspond to the specified keys on the front panel appears. At this time, you can operate the instrument with the specified function menu.

4.4.1.2**Front Panel Key Backlight**

The on/off state and the color of the backlights of some keys on the front panel indicate the working state of the spectrum analyzer. The states are listed below.

1. Power Switch 

- Flash on and off alternatively, in breathing state: indicates that the unit is in stand-by state.
- Constant on: indicates that the instrument is in normal operating state.

2. TG (Option)

When the tracking generator is enabled, the TG key is illuminated; when the tracking generator is disabled, the backlight of the TG key turns off.

3. Single/Continue

For the single sweep mode, the backlight of this menu key is illuminated; for the continuous sweep mode, the backlight of this menu key turns off.

4. Touchscreen Lock Key

When the backlight is on, it indicates that the touch screen of the instrument is locked. Press this key again to unlock the touch screen, and then the backlight is off.

4.4.1.3 Front Panel Connector

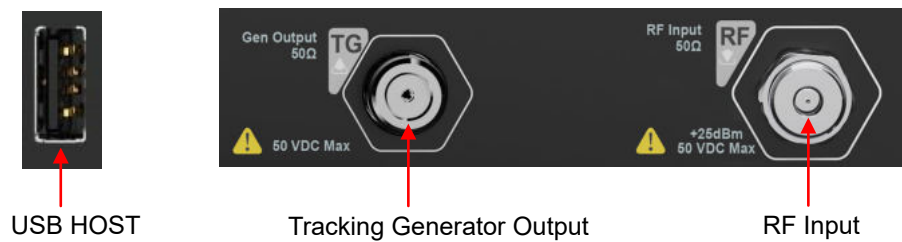

Figure 4.6 Front Panel Connector

1. USB HOST

Used to connect the analyzer that serves as a "master" device to the external USB storage device. The USB storage device, mouse, and keypad board can be connected to the instrument via this interface.

- **USB drive**

Reads the state file, trace + state file, measurement data file, limit line file, FMT file (RTSA mode) or stores the instrument's current status, trace, measurement data, limit line, or FMT on the USB drive, or saves the current screenshot in *.jpg/*.bmp/*.png format to the USB drive.

- **Mouse**

When it is connected, click the specified menu to set the parameters. See the "[Mouse/Keypad Board/Touch Screen Operation Rule](#)" section for details.

- **Keyboard**

When the keyboard is connected, you can use the shortcut keys to simulate as the front panel keys of the instrument. See the "[Mouse/Keypad Board/Touch Screen Operation Rule](#)" section for details.

2. Gen Output 50Ω

Connects it to a receiver through the N-type male cable to output the signal of the tracking generator. It is only available for instruments installed with the RSA6000-T08 option.

CAUTION

To avoid damaging the tracking generator, the reverse power must not exceed +10 dBm at frequencies less than 10 MHz and +20 dBm at frequencies greater than 10 MHz. The reverse DC voltage must not exceed 50 V.

3. RF Input 50Ω

Indicates the input connector of the signal under test. You can use the N-type male cable to connect the [RF Input 50Ω] connector to the device under test (DUT).

CAUTION

To avoid damaging the instrument, the DC voltage component of the signal to the RF input must not exceed 50 V and the AC (RF) signal component must not exceed +25 dBm maximum continuous power.

4.4.1.4 To Use the Numeric Keypad

The numeric keypad is available on the front panel of RSA6000, as shown in the figure below. You can use the numeric keypad to input numbers, common symbols (including decimal point, space, and +/- signs), and unit. You can also use it to set parameters (refer to "[Parameter Setting](#)").

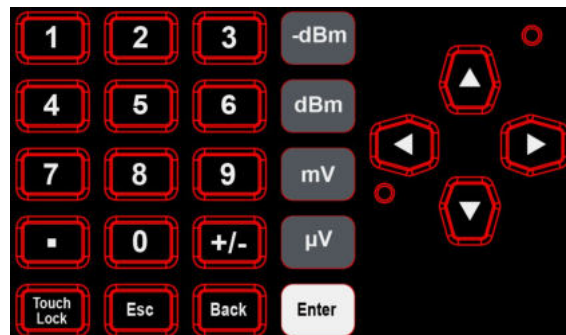

Figure 4.7 Numeric Keypad

The numeric keypad consists of the following parts:

1. Numeric Keys

Used to input a number.

2. Unit Keys

Used to input a measurement unit.

3. Arrow Keys

- Up/Down arrow keys: when you select a function menu, you can use the Up/Down arrow key to switch the menu; when using the numeric key, use the Up/Down arrow key to set the CF step.
- Left/Right arrow keys: When the parameter is editable, use the Left/Right arrow keys to increase or decrease the parameter value at the specific step.

4. 

Press this key to input a decimal point at the current cursor position.

5. 

The number input mode is, by default, selected for parameter setting. Press this key to input the symbol ("+" or "-"). When you press the key first, the parameter symbol "-" is displayed; when you press it again, "+" is displayed.

6. 

- When editing the parameter, press this key to exit parameter input.
- When you edit the filename with the on-screen keyboard, press this key to hide the on-screen keyboard.
- In multi-touch test, single-touch test, and keyboard test state, press this key to exit the current test state.
- When the instrument is in remote mode, press this key to return to the local mode.
- Hide or display the menu.

7. 

- When editing the parameter, press this key to delete the character on the left of the cursor.
- When editing the file name, press this key to delete the character on the left of the cursor.

8. 

During parameter editing, pressing this key will complete the input and insert a default unit for the parameter.

9. 

Locks the touch screen of the instrument.

4.4.2 Rear Panel

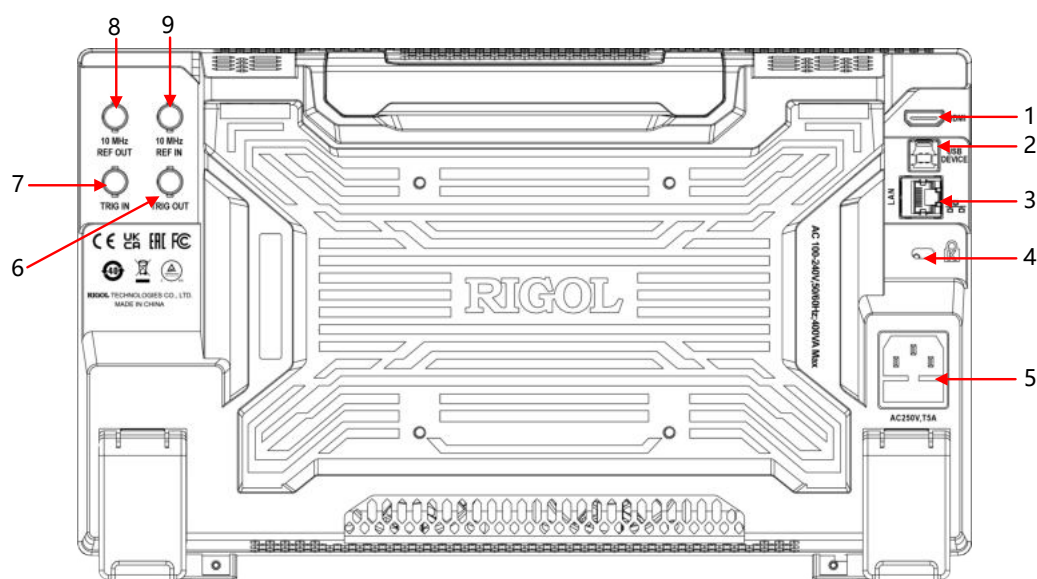

Figure 4.8 Rear Panel

1. HDMI Video Output

Used to connect to the display, enabling you to clearly observe the signal under test and its characteristics.

2. USB DEVICE Interface

The analyzer can serve as a "slave" device to be connected to the external USB device. The analyzer can be connected to the PC through this interface. Then, the RSA6000 series spectrum analyzer can be controlled remotely through programming or the PC software.

3. LAN Interface

Through this interface, the analyzer can be connected to your local network for remote control. The instrument is in compliance with the standards specified in *LXI Device Specification 2011*. It can be used to set up a test system with other standard devices to easily realize the system integration.

4. Security Lock Hole

Use a standard PC/laptop lock cable to secure the instrument to a work bench or other location.

5. AC Power Cord Connector

The rated AC power source supported by the RSA6000 series is 100-240 V, 50-60 Hz.

6. TRIG OUT

Used to output the external trigger signal.

7. TRIG IN

Used to input the external trigger signal. Use a BNC cable to input the external trigger signal to the instrument through this connector.

8. 10MHz REF OUT

RSA6000 can use the internal or external reference source.

- When the internal reference source is used, the **[10MHz REF OUT]** connector can output a 10 MHz clock signal generated by the analyzer to synchronize other instruments.
- The **[10MHz REF OUT]** and **[10MHz REF IN]** connectors are usually used to realize synchronization among multiple instruments.

9. 10MHz REF IN

RSA6000 can use the internal or external reference source.

- When a 10 MHz external clock signal is received at the **[10MHz REF IN]** connector, this signal is used as the external reference source. At this time, "Ext" is displayed in the status bar of the user interface. When the external reference signal is lost, over the limit, or disconnected, the instrument switches to the internal reference automatically. At this time, "Ext" is displayed in the status bar of the user interface.
- The **[10MHz REF IN]** and **[10MHz REF OUT]** connectors are usually used to realize synchronization among multiple instruments.

4.4.3 User Interface



Figure 4.9 User Interface

No.	Name	Description
1	Multi-pane Windowing Display Area	If you enable multiple functions, multiple windows can be displayed on the screen at one time.
2	Measurement Parameter Display Area	Displays measurement parameters such as the frequency, amplitude, span, trigger, and trace indicator ^[1] .
3	Quick Operation Menu	Displays the quick operation menu.
4	Menu Control Operation Area	Sets the measurement parameters for the specified measurement such as Meas Setup, Frequency, Span, Sweep, Amplitude, Bandwidth, Trace, Marker, and etc.
5	Notification Area	Displays the USB storage device icon, LAN connection icon, sound icon, remote control icon, and system time. You can click or tap this area to enter the System menu.
6	Working Mode	Displays the currently selected working mode. You can also add or delete the selected working mode. The

No.	Name	Description
		analyzer provides five modes: GPSA, RTSA, VSA, EMI, and ADM.
7	Function Navigation Icon	Click or tap the icon  to open the function navigation menu. Click or tap the specified menu icon to enter the specified function setting menu.

**NOTE**

[1]: The trace indicator is shown in the following figure.

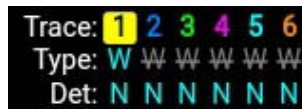

- The first line displays the trace number. The color of the number is the same as that of the trace.
- The second line displays the trace type, including W (Clear/Write), A (Trace Average), M (Maximum Hold), and m (Minimum Hold). The letters with different colors and in different forms show different meanings:
 - The letter in blue indicates that the trace is updating.
 - The letter in gray indicates that the trace is not updated.
 - The letter with strikethrough and in gray color indicates that the trace will neither be updated nor displayed.
 - The letter with strikethrough and in blue color indicates that the trace is updating but not displayed. It is useful in trace math operation.
- The third line displays the detector type of each trace, including N (Normal, only available in GPSA mode), V (Voltage Average, only available in GPSA mode), P (Positive Peak), p (Negative Peak), S (Sample), R (RMS Average, only available in GPSA mode), Q (Quasi-Peak, only available in GPSA mode), A (Average, only available in RTSA mode), and C (C-RMS Average, only available in GPSA mode). If it shows "f", it indicates that it is math operation trace. The letter in blue in the third line (detector type) indicates that the detector is in auto state; the letter in white indicates that it is in manual state.

4.5 Mouse/Keypad Board/Touch Screen Operation Rule

4.5.1 Mouse Operation Rule

Connect the mouse to the instrument via the USB HOST interface to perform the following operations. Note that you can only use the left mouse button to perform the left-click operation. Left-right click and mouse rolling operation are not allowed.

1. Click the mouse to select the menu and window.

2. Long press the left mouse button to drag the displayed data or window.
3. In the Marker menu, click the mouse to move the marker, but you are unable to use the mouse to add a marker.

4.5.2 Keypad Board Operation Rule

After the keypad board is properly connected to the instrument via the USB HOST interface, and then you can use the shortcut keys on the keypad to perform the same function as what you do with the Function Key. The following table lists the short-cut key that corresponds to the function key.

Function Key	Keypad Shortcut Key ^[1]
Mode	Alt + o
Meas Setup ^[2]	Shift + e
Auto	Ctrl + Alt + a
Preset	Ctrl + Alt + p
Freq ^[2]	Shift + f
AMPT ^[2]	Shift + a
BW ^[2]	Shift + b
Trace ^[2]	Shift + t
Sweep ^[2]	Shift + w
Input Output ^[2]	Shift + i
TG ^[2]	Shift + g
Single/Continue	F11
Marker ^[2]	Shift + m
Marker To ^[2]	Shift + k
Peak ^[2]	Shift + p
Marker Function ^[2]	Shift + u
Trigger ^[2]	Shift + r

Function Key	Keypad Shortcut Key ^[1]
System ^[2]	Shift + y
Restart	F12
Recall	Ctrl + r
Quick save	Ctrl + Alt + q
Help	Alt + F1
	Alt + F3
10 Numeric Keys and 1 Decimal Point	Numeric keys (1, 2, 3, 4, 5, 6, 7, 8, 9, 0) and dot (.)
-	-
Esc	Esc
Back	Backspace
Enter	Enter
Arrow Keys (Up/Down, Left/Right)	↑, ↓, ←, →

NOTE

[1]: Except the short-cut keys mentioned in the above table, other user-defined keys are invalid.

[2]: If the Caps Lock key is enabled, it indicates that you have pressed down the Shift key. Therefore, all the short-cut key concerning "Shift+letter" operations can be performed by just pressing down the specified letter when the Caps Lock key is enabled. For example, if you want to use the short-cut key "Shift+f" to perform the specified operation, first enable the Caps Lock key, then press down the letter "f".



4.5.3 Touch Screen Operation Rule

RSA6000 series provides 10.1" capacitive multi-touch screen; supporting many gesture-enabled touch operations.

1. In the non-Marker menu:

- Using one finger to slide left and right in the trace window can modify the center frequency; using one finger to slide up and down in the trace window can modify the reference level.

- Stretching and pinching two fingers horizontally in the trace window can reduce and increase the span respectively. Stretching and pinching two fingers vertically in the trace window can reduce and increase the Y-scale respectively.

2. In the Marker menu:

- In the blank area of the marker trace, long tapping on the area can add one marker.
- Tapping the marker and holding on it can drag the marker.

4.6 Menu Operation

The menu types can be divided into six types. The following section introduces how to operate for each menu type.

1. Input a parameter value

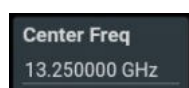

Click or tap the input field of the specified parameter to input a value. For example, click or tap the input field of **Center Freq**, then the numeric keypad is displayed.

Input a value, then click or tap  to confirm inputting the value.

2. Toggle between the menu options

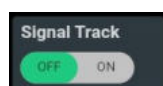

Click or tap the menu options of the specified menu to toggle the menu option. For example, click or tap the ON/OFF tab for **Signal Track** to enable or disable the signal tracking.

3. Direction operation on the menu



Click or tap the corresponding menu key directly to perform the corresponding function. For example, click or tap **Marker -> CF** to set the marker frequency as the center frequency of the spectrum analyzer.

4. Select from the drop-down list of the menu

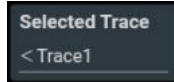

Click or tap the drop-down button of the specified menu to select the desired option. For example, click or tap **Trace** > **Selected Trace** > **Trace 1** to select Trace 1. Then, you can set related parameters for Trace 1.



TIP

All of the above menu actions can be performed using an external mouse or touch screen gesture. Alternatively, you can use an external keyboard shortcut keys. For the relationship between the front-panel keys and keyboard shortcuts, refer to *Front-Panel Keys*.

4.7 Parameter Setting

Parameter input can be done via the front panel numeric keypad, rotary knob or arrow keys, or via the touch screen or external keyboard, mouse settings. This section provides an example of the six parameter setting methods (setting the center frequency to 800 MHz).

1. Use Numeric Keypad

- a. Press **Freq** > **Center Freq**;
- b. Input the value "800" using the numeric keypad;
- c. Select the desired unit "MHz".

2. Knob

When the parameter is in editing mode, rotate the knob clockwise to increase or counterclockwise to decrease the parameter value at the specified step.

- a. Press **Freq** > **Center Freq**;
- b. Rotate the knob to get the desired parameter value (800 MHz).

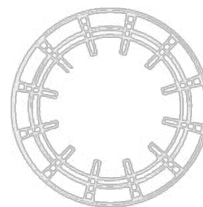

Figure 4.10 Knob

3. Arrow Keys

When the parameter is editable, use the arrow keys to increase or decrease the parameter value at the specific step. Note that the step sizes for the Up/Down arrow key and the Left/Right arrow key are different.

- a. Press **Freq** > **Center Freq**;
- b. Press the Left/Right arrow keys until you get the desired parameter value (800 MHz).

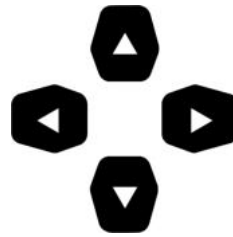

Figure 4.11 Arrow Keys

4. Use Touch Screen

- a. Click or tap **Frequency** to enter the frequency setting menu.
- b. Click or tap **Center Freq**;
- c. Input 800 using the pop-up numeric keypad and select the desired unit "MHz".

5. Use Externally Connected Keyboard

- a. Press Shift + f to open the **Frequency** menu;
- b. Press F1 to select the **Center Freq**;
- c. Enter the value "800" using the numeric keypad;
- d. Press F2 to select the desired unit in the pop-up units menu, MHz.

For the keyboard shortcut keys that correspond to the instrument front panel keys, refer to *Front Panel Keys to Keyboard*.

6. Use Externally Connected Mouse

- a. Click on the menu bar on the right side of the touch screen with an external mouse, and click **Frequency**.
- b. Click on the **Center Freq** menu;
- c. Enter 800 using the pop-up numeric keypad and select the desired unit "MHz".

4.8 To Use the Built-in Help System

The built-in help document of the RSA6000 series provides information about the functions and menu introductions of the instrument.

Click or tap  > **Help** to enter the help system. You can get its help information by clicking on the link for the introduction of the specified function.

4.9 To Replace the Fuse

If you need to replace the fuse, please use the proper fuse (AC 250 V, T5 A; 5.2 mm×20 mm) and follow the steps shown below.

1. Power off the instrument and remove the power cord.
2. Insert a small straight screwdriver into the slot at the power socket and pry out the fuse holder gently.
3. Remove the fuse.
4. Insert the proper fuse into the fuse holder.
5. Re-insert the fuse holder into the power socket.

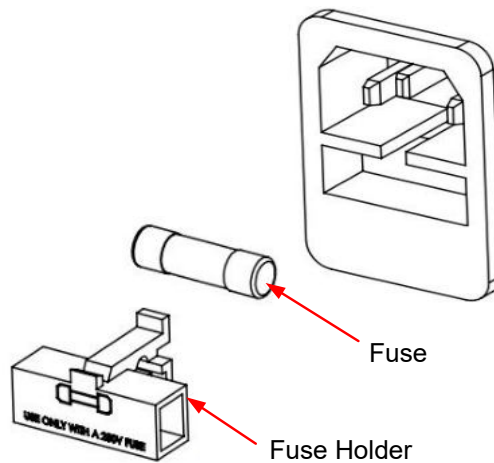

Figure 4.12 Replace the Fuse



WARNING

To avoid electric shock, please make sure that the instrument is powered off and disconnected from the power before replacing the fuse. Also, please make sure the fuse is consistent with the required fuse rating.

4.10 To View the Option and the Option Installation

This series spectrum analyzer provides many options to meet various measurement requirements. If you need any of these options, order them according to the Order No. available in *Appendix A: Options and Accessories*, and then install the options according to this section. Besides, you can also view the options currently installed on the spectrum analyzer and activate the newly purchased option.

1. View the installed option

If your instrument has currently installed the option, perform the following operations to view the name of the installed option and other detailed information about the option from the option list.

- Click or tap the function navigation icon  at the lower-left corner of the screen, and then select **System** to enter the system setting menu.
- Click or tap **Options** to view the options currently installed.

2. Install the Option

The option license is a string with a fixed number of characters. Each instrument has one unique license. The license file should be in specific format, with the filename extension "*.lic". After you purchase an option, you will obtain a key (used for obtaining the license). Then, you can install the option according to the following steps.

a. Obtain an option license

- a. Log in to the RIGOL official website (<http://www.rigol.com>), click **SERVICE CENTRE > License Activation** to enter the license activation interface.
- b. Input the correct key, serial number (To obtain the serial number, click or tap the function navigation icon  at the lower-left corner of the screen first, then click or tap **System**. Click or tap **About** to acquire the serial number of the instrument.), and verification code. Click **Generate** to acquire the download link for the option license file.

b. Install the option

- a. Install the option by sending SCPI commands. For details, refer to *RSA6000 Programming Guide*.
- b. After installation, a prompt message "Option activated successfully" is displayed. After the option has been installed, you are recommended to restart the instrument.

**TIP**

- During the installation process, you are not allowed to power off the instrument.
- Installing options by sending SCPI commands is supported. Installing options by inputting the license code manually is not supported.

4.11 Mode Setting

4.11.1 Mode

RSA6000 series real-time spectrum analyzer provides two working modes: GPSA (general purpose spectrum analyzer) and RTSA (real-time spectrum analyzer).

1. GPSA

GPSA adopts two analysis methods: swept SA and FFT. It can not only carry out frequency domain analysis, but also time domain (zero span) analysis.

Select GPSA. In this working mode, you can press "Mode/Meas" to select multiple measurements. For details, refer to relevant chapters in *RSA6000 User Guide*.

2. RTSA

RTSA provides the real-time signal analysis function, enabling you to capture the complex signal seamlessly.

Select RTSA. In this working mode, you can also press "Mode/Meas" to select multiple measurements. For details, refer to relevant chapters in *RSA6000 User Guide*.

**NOTE**

In different working modes, the functions of the keys on the front panel may be different. Click

or tap  > **Help** to display the help information of the current working mode. If you need help information for other modes, please exit the help interface first. Then select the desired working mode and obtain the corresponding help information.

5 Functions of the Front Panel of GPSA

This chapter describes in detail the function keys on the front panel of RSA6000 and their associated menu functions in GPSA mode.

5.1 Basic Settings

5.1.1 Freq

Press **Freq** to set the frequency and span of the spectrum analyzer.

Frequency Setting

Click or tap **Setting** to set the frequency parameters of the analyzer. The analyzer sweeps within a specified frequency range and restarts sweeping every time the frequency parameters are modified.

The frequency range of a channel can be expressed by either of two groups of parameters: Start Frequency/Stop Frequency (f_{start} / f_{stop}); or Center Frequency/Span (f_{center} / f_{span}). If any of the four parameters is changed, the other three parameters will make adjustment automatically to ensure the coupling relationship among them:

$$f_{center} = (f_{stop} + f_{start}) / 2$$

$$f_{span} = f_{stop} - f_{start}$$

Span

Click or tap **Span** to set the span of the analyzer. Changing this parameter will change the frequency parameters, and after the span is changed, the sweep restarts.

5.1.1.1 Center Frequency

Sets the center frequency of the current channel. Click or tap **Center Freq** to set the center frequency. The center frequency and span values are respectively displayed at the lower left and right of the graticule.

Key Points:

- When you modify the center frequency, the start and stop frequency will be modified automatically if the span remains to be unchanged.

- Modifying the center frequency indicates that the frequency is changed along the current channel horizontally, and the adjustable range should be within the frequency range specified in the technical specifications of the analyzer.
- In zero span mode, the values of start frequency, stop frequency, and center frequency are the same, so once one of the parameter values is modified, the other two values will be modified automatically.
- You can use the numeric keys, the knob, and the arrow keys on the front panel to modify this parameter; also you can modify it on the touchscreen. For details, refer to descriptions in *Parameter Setting*.

Parameter	Remarks
Default	$F_{\max}^{[1]}/2$
Range	$(S_{\min}/2)^{[2]}$ to $(F_{\max} - S_{\min}/2)$
Unit	GHz, MHz, kHz, Hz
Knob Step	span > 0, step = span/200 span = 0, step = RBW/100 Min = 1 Hz
Left/Right Arrow Key Step	CF step



NOTE

[1]: The maximum frequency F_{\max} is determined by the instrument model. RSA6000 includes 8.5 GHz model, 14 GHz, and 26.5 GHz model.

[2]: S_{\min} indicates the minimum span in non-zero mode.

5.1.1.2

Start Freq

Sets the start frequency of the current frequency channel. The start frequency and stop frequency values are respectively displayed at the lower left and right side of the graticule.

Remarks:

- When you modify the start frequency, the span and center frequency will be changed. The changes of span will affect other system parameters. For details, please refer to *Span*.

- In zero span mode, the values of start frequency, stop frequency, and center frequency are the same, so once one of the parameter values is modified, the other two values will be modified automatically.
- You can use the numeric keys, the knob, and the arrow keys on the front panel to modify this parameter; also you can modify it on the touchscreen. For details, refer to descriptions in *Parameter Setting*.

Parameter	Remarks
Default	center frequency - span/2
Range ^[1]	0 Hz to F_{\max}
Unit	GHz, MHz, kHz, Hz
Knob Step	span > 0, step = span/200 span = 0, step = RBW/100 Min = 1 Hz
Left/Right Arrow Key Step	CF step

**NOTE**

[1]: In non-zero span mode, its range is from 0 Hz to ($F_{\max} - 10$ Hz).

5.1.1.3**Stop Freq**

Sets the stop frequency of the current frequency channel. The start frequency and stop frequency values are respectively displayed at the lower left and right side of the graticule.

Remarks:

- When you modify the stop frequency, the span and center frequency will be changed. The changes of span will affect other system parameters. For details, please refer to *Span*.
- In zero span mode, the values of start frequency, stop frequency, and center frequency are the same, so once one of the parameter values is modified, the other two values will be modified automatically.

- You can use the numeric keys, the knob, and the arrow keys on the front panel to modify this parameter; also you can modify it on the touchscreen. For details, refer to descriptions in *Parameter Setting*.

Parameter	Remarks
Default	center frequency + span/2
Range ^[1]	0 Hz to F _{max}
Unit	GHz, MHz, kHz, Hz
Knob Step	span > 0, step = span/200 span = 0, step = RBW/100 Min = 1 Hz
Left/Right Arrow Key Step	CF step



NOTE

[1]: The range is from 10 Hz to F_{max} in non-zero span.

5.1.1.4 Freq Offset

You can set a frequency offset value to indicate the frequency conversion between the device under test (DUT) and the input terminal of the spectrum analyzer.

Remarks:

- The change of this parameter only changes the display values of the center frequency, start frequency, and stop frequency; but does not affect any hardware settings of the spectrum analyzer.
- You can use the numeric keys, the knob, and the arrow keys on the front panel to modify this parameter; also you can modify it on the touchscreen. For details, refer to descriptions in *Parameter Setting*.
- To eliminate the frequency offset, you can set the frequency offset to 0 Hz.

Parameter	Remarks
Default	0 Hz
Range	-500 GHz to 500 GHz

Parameter	Remarks
Unit	GHz, MHz, kHz, Hz
Knob Step	span > 0, step = full span/200
Left/Right Arrow Key Step	CF step

5.1.1.5 CF Step

Used to change the step size for the center frequency. Changing the center frequency by a constant step-size value switches the channel to be measured continuously.

Remarks:

- Set a proper CF step value, and then select the center frequency. Use the the Left/Right arrow key to switch the measurement channel at a fixed step size. Thus, the instrument can sweep the adjacent channels manually.
- You can use the numeric keys, the knob, and the arrow keys on the front panel to modify this parameter; also you can modify it on the touchscreen. For details, refer to descriptions in *Parameter Setting*.

Parameter	Remarks
Default	Fmax/10
Range	-Fmax to Fmax
Unit	GHz, MHz, kHz, Hz
Knob Step	span > 0, step = span/200 span = 0, step = RBW Min = 1 Hz
Left/Right Arrow Key Step	at 1-2-5 step

5.1.1.6 CF Step Mode

The CF step mode consists of "Manual" and "Auto".

Remarks:

- In Auto mode, the CF step is 1/10 of the span in non-zero span mode or equals to RBW while in zero span mode.

- In Manual mode, you can use the numeric keys to set the step size.

5.1.1.7 Signal Track

Enables or disables the signal tracking function. This function is used to track and measure the signal whose frequency is unstable and whose transient variation in amplitude is less than 3 dB. Place Marker1 (refer to descriptions in *Marker Measurement*) onto the signal under test to track and measure the variation of the signal.

Key Points:

- If an active marker currently exists, when Signal Track is enabled, the instrument will search for and mark the point (whose amplitude variation is less than 3 dB) near the marker. Then, set the frequency at this point to be the center frequency to keep the signal at the center of the screen.
- If no marker is currently active, when Signal Track is enabled, the instrument will activate Marker1, execute a peak search automatically, and set the frequency value at the current peak to be the center frequency to keep the signal always displayed at the center of the screen.
- In continuous sweep, the system tracks the signal continuously; in single sweep, the instrument only performs a single signal track.
- The signal tracking function is only applicable to the sweep analysis. The signal tracking function is invalid in the following conditions:
 - In zero span mode;
 - When the tracking generator is enabled;
 - When the trace is not updated;
 - When the continuous peak search is enabled;
 - Advanced measurement.

5.1.1.8 X-axis Scale Type

Selects the scale type of X-axis to Lin or Log. By default, it is "Lin".

- If you select log scale, the frequency in the X-axis is displayed in log form.

- When the scale type of X-axis is set to Log and any advanced measurement function (including T-Power, ACP (Adjacent Channel Power), Chan Pwr (Channel Power), OBW (Occupied Bandwidth), EBW (Emission Bandwidth), C/N Ratio, Harmo Dist (Harmonic Distortion) and TOI (Third Order Intercept)) is selected, the instrument switches the scale type of X-axis to Lin automatically.

5.1.1.9 Span

Sets the frequency range of the current channel. The center frequency and span values are respectively displayed at the lower left and right side of the graticule.

Remarks:

- When you modify the span, the start and stop frequency will be modified automatically if the center frequency remains to be unchanged.
- In non-zero span mode, the minimum span can be set to 10 Hz. When the span is set to a maximum value, the analyzer enters full span mode.
- You can set the span to 0 Hz manually. You can also click or tap **Zero Span** or run the SCPI commands to enter the zero span mode.
- When you modify the span in non-zero span mode, both CF step and RBW will be changed automatically if they are in Auto mode. Besides, the change of RBW will change the value of VBW (in Auto VBW mode).
- Any variation in span, RBW, or VBW would cause a change in the sweep time.
- You can use the numeric keys, the knob, and the arrow keys on the front panel to modify this parameter; also you can modify it on the touchscreen. For details, refer to descriptions in *Parameter Setting*.

Parameter	Remarks
Default	F_{\max}
Range ^[1]	0 Hz, 10 Hz to F_{\max}
Unit	GHz, MHz, kHz, Hz
Knob Step	span > 0, step = span/200 span = 0, step = 10 Min = 2 Hz
Left/Right Arrow Key Step	at 1-2-5 step

**NOTE**

[1]: When the span is set to 0 Hz, the instrument enters the zero span mode.

5.1.1.10 Last Span

Sets the span to its last modified value.

5.1.1.11 Full Span

Sets the maximum span.

5.1.1.12 Zero Span

Sets the span to 0 Hz. The values of start frequency and stop frequency are the same as that of the center frequency. The X-axis is time. The analyzer measures the time-domain characteristics of the amplitude at the center frequency point of the input signal.

Key Points:

The zero span mode displays the time-domain characteristics of the signal's fixed frequency components. Great differences can be found between the zero span and the non-zero span. The following functions are invalid in zero span mode.

- "Signal Track" under Frequency menu;
- "Marker > CF", "Marker > CF Step", "Marker > Start", "Marker > Stop", "MarkerΔ > CF", and "MarkerΔ > Span" under "Marker" menu.

5.1.2 Display

5.1.2.1 Display Setting

1. Selected Display Line

The available display lines are Display Line1, Display Line2, Display Line3, and Display Line4.

2. Display Line State

Enables or disables the display of the display line.

3. Display Line

Sets the display line level to change its display location. This line can be used as either the reference for you to read the measurement result or the threshold condition for the peaks displayed in the peak table.

Remarks:

- This line is a horizontal reference of which the amplitude is equal to the set value, and the corresponding amplitude unit is the same as the Y-axis unit.
- You can use the numeric keys, the knob, and the arrow keys on the front panel to modify the display line level; also you can modify it on the touchscreen. For details, refer to descriptions in *Parameter Setting*.
- If there are multiple windows in the user interface, the settings of the display line take effective in the selected window.
- If the display line is out of the visible range, it will be displayed at the top or bottom of the graticule.

Parameter	Remarks
Default	-25 dBm
Range	Current amplitude range
Unit	dBm, -dBm, V, mV, uV
Knob Step	In Log scale mode, step = scale/10 In Lin scale mode, step = 0.1 dB
Left/Right Arrow Key Step	In Log scale mode, step = scale In Lin scale mode, step = 1 dB

4. Selected Frequency Line

The available frequency lines are Freq Line1, Freq Line2, Freq Line3, and Freq Line4.

5. Frequency Line State

Enables or disables the display of the frequency line.

6. Frequency Line

The frequency line can be currently served as the readout reference line. The available selected frequency lines include Freq Line1, Freq Line2, Freq Line3, and Freq Line4. By default, Freq Line1 is selected.

Key Points:

- The frequency line is only valid in the non-zero span view.
- By default, the value of frequency line is 0 Hz.

- The frequency line value is saved automatically after it is modified. It will be restored to its default value when you restart the instrument or perform the Preset operation.

7. Selected Time Line

The available selected time lines are Time Line1, Time Line2, Time Line3, and Time Line4.

8. Time Line State

Enables or disables the display of the time line.

9. Time Line

Time line is a vertical line that can be adjustable, which can be used as the visual reference line. The horizontal position of the time line corresponds to its time value.

Key Points:

The settings for the time line-related parameters are only valid in zero span mode.

5.1.3 Ampt

Sets the amplitude parameters of the analyzer. You can modify these parameters to make the signals under test be displayed with minimal errors in the current window, easy for you to observe.

5.1.3.1 Reference Level

Sets the maximum power or voltage that can be displayed in the current window.

Key Points:

The RF link is limited by the maximum mixer level, so when you reduce the attenuation, the instrument may reduce the reference level to meet the mixer level limit. When you increase the attenuation, the reference level remains unchanged.

- You can use the numeric keys, the knob, and the arrow keys on the front panel to modify this parameter; also you can modify it on the touchscreen. For details, refer to descriptions in *Parameter Setting*.

Parameter	Remarks
Default	0 dBm
Range	-170 dBm to 25 dBm
Unit	dBm, -dBm, V, mV, uV

Parameter	Remarks
Knob Step	In Log scale mode, step = scale/10 In Lin scale mode, step = 0.1 dB
Left/Right Arrow Key Step	In Log scale mode, step = scale In Lin scale mode, step = 0.1 dB

5.1.3.2 Attenuation

Sets the RF front-end attenuator to allow high-level signals to pass through the mixer with low distortion, and low-level signals to pass through the mixer with low noise.

Remarks:

- The attenuator consists of fixed attenuator and variable attenuator. The attenuation of the fixed attenuator is 10 dB, and the attenuation range of the variable attenuator is from 0 dB to 30 dB. Therefore, the input attenuation ranges from 0 dB to 40 dB.
- When the set attenuation amount is greater than 10 dB, fixed attenuator is preferred to be used by default.
- When the maximum mixer level and reference level are confirmed, the minimum of the input attenuation should meet the following equation:

$$ATT_{min} = L_{Ref} + a_{PA} + a_{Ext} - L_{Offset} - L_{mix}$$

Wherein, ATT_{min} , L_{Ref} , a_{PA} , a_{Ext} , L_{Offset} , and L_{mix} indicate the minimum input attenuation, reference level, PA, external gain, reference level offset, and maximum mixer level, respectively.

- You can use the numeric keys, the knob, and the arrow keys on the front panel to modify this parameter; also you can modify it on the touchscreen. For details, refer to descriptions in [Parameter Setting](#).

Parameter	Remarks
Default	10 dB
Range	0 dB to 40 dB
Unit	dB

Parameter	Remarks
Knob Step	Preamp off, step = 2 dB
Left/Right Arrow Key Step	4 dB

5.1.3.3 Attenuation Mode

Selects "Manual" or "Auto" to be the current attenuation mode.

Remarks:

- If you select "Manual" to be the attenuation mode, set the attenuation value under the "Attenuation" menu, and the attenuation mode will be automatically switched to "Manual".
- When you select "Auto" to be the attenuation mode, the attenuator will automatically adjust the attenuation value to meet the current amplitude setting.

5.1.3.4 Preamplifier

Sets the RF front-end preamplifier to be on or off. When the signal under test is a low-level signal, turning on the preamplifier can reduce the displayed average noise level, so that you can distinguish low-level signals from the noise. By default, the preamp gain is 20 dB.

5.1.3.5 Y Axis Unit

Sets the unit of the Y-axis to dBm, dBmV, dBμV, Volts, Watts, or Ampere. Wherein, dBm, dBmV, and dBμV are for Log unit; Volts and Watts are for Linear unit; Ampere is the current unit. The default unit is dBm.

Key Points:

The conversion relations between units are as follows:

$$dBm = 10lg\left(\frac{Volts^2}{R} \times \frac{1}{0.001W}\right)$$

$$dB\mu V = \left(20lg \frac{Volts}{1\mu V}\right)$$

$$dBmV = \left(20lg \frac{Volts}{1mV}\right)$$

$$Watts = \frac{Volts^2}{R}$$

$$Ampere = \frac{Volts}{R}$$

Wherein, R denotes the reference resistance.

5.1.3.6 Y-axis Scale Type

Sets the scale type of the Y-axis to Lin or Log. By default, it is Log.

Remarks:

- In Log scale type, the Y-axis denotes the logarithmic coordinate. The top line of the graticule is the reference level, and the scale per division represents the scale value. When the scale type is changed from Lin to Log, the unit of Y-axis will automatically switch to the default unit (dBm) in Log scale type.
- In Lin scale type, the Y-axis denotes the linear coordinate. The top line of the graticule is the reference level, and 0 V is at the bottom of the graticule. Each vertical division of the graticule represents one-tenth of the reference level. The scale setting function is invalid. When the scale type is changed from Log to Lin, the unit of Y-axis will automatically switch to the default unit (Volts) in Lin scale type.
- The scale type does not affect the unit of Y-axis.
- If *Normalize* is enabled, "Log" is selected to be the scale type by default, and this menu is grayed out and disabled.

5.1.3.7 Scale/Div

Sets the logarithmic units per vertical grid division on the display. This function is only available when the scale type is set to "Log".

Remarks:

- The amplitude range to be displayed can be adjusted by setting the scale.
- The currently displayed range of the signal amplitude is as follows:
Min. value: reference level – 10 x current scale value;

Max. Value: reference level

- You can use the numeric keys, the knob, and the arrow keys on the front panel to modify this parameter; also you can modify it on the touchscreen. For details, refer to descriptions in *Parameter Setting*.

Parameter	Remarks
Default	10 dB
Range	0.1 dB to 20 dB
Unit	dB
Knob Step	Scale/Div \geq 1, step = 1 dB Scale/Div $<$ 1, step = 0.1 dB
Left/Right Arrow Key Step	at 1-2-5 step

5.1.3.8 Max Mixer Level

Sets the maximum input level of the mixer according to the amplitude of the signal.

Remarks:

- For the high-level input signal, select a smaller maximum mixer level to increase the input attenuation and reduce the distortion of the signal; for the low-level input signal, select a larger maximum mixer level to reduce the input attenuation and noise.
- You can use the numeric keys, the knob, and the arrow keys on the front panel to modify this parameter; also you can modify it on the touchscreen. For details, refer to descriptions in *Parameter Setting*.

Parameter	Remarks
Default	-10 dBm
Range	-40 dBm to -10 dBm
Unit	dBm, -dBm, mV, μ V
Knob Step	1 dBm
Left/Right Arrow Key Step	5 dBm

5.1.3.9 Ref Offset

Adds an offset value to the reference level to compensate for gains or losses generated between the DUT and the analyzer input.

Remarks:

- The offset value does not affect the trace position, but will modify the reference level readout and the marker amplitude readout.
- You can use the numeric keys, the knob, and the arrow keys on the front panel to modify this parameter; also you can modify it on the touchscreen. For details, refer to descriptions in *Parameter Setting*.

Parameter	Remarks
Default	0 dB
Range	-300 dB to 300 dB
Unit	dB
Knob Step	1 dB
Left/Right Arrow Key Step	1 dB

5.2 Sweep and Function Settings

5.2.1 Bandwidth

Sets the resolution bandwidth (RBW) and video bandwidth (VBW) value of the spectrum analyzer.

5.2.1.1 Resolution Bandwidth (RBW)

Sets the resolution bandwidth (RBW) to distinguish two signals whose frequencies are close with each other.

Remarks:

- Reducing RBW can gain a higher frequency resolution, but will also prolong the sweep time (when sweep time is set to Auto, it will be affected by both RBW and VBW).

- You can use the numeric keys, the knob, and the arrow keys on the front panel to modify this parameter; also you can modify it on the touchscreen. For details, refer to descriptions in *Parameter Setting*.

Parameter	Remarks
Default	10 MHz
Range	1 Hz to 10 MHz
Unit	GHz, MHz, kHz, Hz
Knob Step	at 1-3-10 step
Left/Right Arrow Key Step	at 1-3-10 step



NOTE

You can only set RBW to 200 Hz, 9 kHz, 120 kHz, or 1 MHz when the detector type is "Quasi-Peak".

5.2.1.2 RBW Mode

Sets the coupling mode of RBW.

Remarks:

- When you set RBW Mode to "Auto", RBW is in auto coupling state. Its value changes with the span (non-zero span), and the value is determined by span/RBW ratio. You can set RBW Mode to "Manual" or directly set the RBW value to change the coupling mode.
- When you perform the Preset operation, the coupling state is Auto.
- In zero span mode, RBW Mode is, by default, set to "Manual".

5.2.1.3 Span/RBW Ratio

Sets the ratio of span to RBW. You can use the numeric keys, the knob, and the arrow keys on the front panel to modify this parameter; also you can modify it on the touchscreen. For details, refer to descriptions in *Parameter Setting*.

Parameter	Remarks
Default	106
Range	2 to 10,000

Parameter	Remarks
Unit	None
Knob Step	at 1-2-5 step
Left/Right Arrow Key Step	at 1-2-5 step

5.2.1.4 Span/RBW Mode

Sets the coupling mode of the Span/RBW ratio.

Remarks:

- When you set Span/RBW Mode to "Auto", "Span/RBW Ratio" is in auto coupling state, and its value is 106. You can set Span/RBW Mode to "Manual" or directly set the Span/RBW ratio to change the coupling mode.
- When you perform the Preset operation, the coupling state is Auto.
- In zero span mode, Span/RBW Mode is disabled.

5.2.1.5 Video Bandwidth

Sets the video bandwidth (VBW) to filter out the noises outside the video band.

Remarks:

- Reducing VBW makes the spectral line smoother, so that the low-level signal in the noise can be detected, but this will also prolong the sweep time (when sweep time is set to Auto, it will be affected by both RBW and VBW).
- You can use the numeric keys, the knob, and the arrow keys on the front panel to modify this parameter; also you can modify it on the touchscreen. For details, refer to descriptions in *Parameter Setting*.

Parameter	Remarks
Default	10 MHz
Range	1 Hz to 10 MHz
Unit	GHz, MHz, kHz, Hz
Knob Step	at 1-3-10 step

Parameter	Remarks
Left/Right Arrow Key Step	at 1-3-10 step

5.2.1.6 VBW Mode

Sets the coupling mode of the VBW and the VBW/RBW ratio.

Remarks:

- When you set VBW Mode to "Auto", VBW is in auto coupling state. Its value changes with the RBW value, and the value is determined by VBW/RBW ratio. You can set VBW Mode to "Manual" or directly set the VBW value to change the coupling mode.
- When you perform the Preset operation, the coupling state is Auto.

5.2.1.7 VBW/RBW Ratio

Sets the ratio of VBW to RBW.

You can use the numeric keys, the knob, and the arrow keys on the front panel to modify this parameter; also you can modify it on the touchscreen. For details, refer to descriptions in *Parameter Setting*.

Parameter	Remarks
Default	1
Range	0.00001 to 3,000,000
Unit	None
Knob Step	at 1-3-10 step
Left/Right Arrow Key Step	at 1-3-10 step

5.2.1.8 VBW/RBW Mode

Sets the coupling mode of the VBW/RBW ratio.

Remarks:

- When you set VBW/RBW Mode to "Auto", "VBW/RBW ratio" is in auto coupling state, and its value is determined by auto rule value. You can set VBW/RBW Mode to "Manual" or directly set the VBW/RBW ratio to change the coupling mode.

- When you perform the Preset operation, the coupling state is Auto.

5.2.1.9 Filter Type

Sets the RBW filter type.

Key Points:

- RSA6000 supports two kinds of RBW filters: "Gauss" (-3 dB bandwidth) and "EMI" (-6 dB bandwidth).
- When "EMI" is selected, the resolution bandwidth can only be set to 200 Hz, 9 kHz, 120 kHz, or 1 MHz. The default filter type is "Gauss". The instrument will switch to "EMI" filter automatically when "Quasi-Peak" detector is selected.

5.2.1.10 Auto Couple

When you enable "Auto Couple" function, all the manual/auto settings in the current bandwidth menu will be set to "Auto". This operation does not affect other measurement modes.

In auto state, the auto coupled parameters are changed with their coupled parameters. The auto coupling operation will ensure the optimal performance of the instrument. After the operation, all the auto coupled parameters will immediately be automatically reset based on the coupled parameters.

5.2.2 Sweep

Sets sweep-related parameters, such as sweep time, sweep points, and sweep mode.

5.2.2.1 Sweep Points

Sets the number of points acquired in each sweep, i.g. the number of the trace points.

Remarks:

- With the increase of the sweep points, the frequency resolution of the marker will increase with it, but the sweep speed will decrease with it.
- Due to the limitation of the minimum interval of sweep points, when the number of sweep points is increased, the sweep time will be prolonged.
- Changing the number of the sweep points will affect multiple parameters of the system. Therefore, the system will make a new sweep and measurement again.

- You can use the numeric keys, the knob, and the arrow keys on the front panel to modify this parameter; also you can modify it on the touchscreen. For details, refer to descriptions in *Parameter Setting*.

Parameter	Remarks
Default	801
Range	101 to 100,001
Unit	None
Knob Step	1
Left/Right Arrow Key Step	5

5.2.2.2 Sweep Time

Sets the time required for the spectrum analyzer to complete one sweep operation within the span range.

Remarks:

- You can use the numeric keys, the knob, and the arrow keys on the front panel to modify this parameter; also you can modify it on the touchscreen. For details, refer to descriptions in *Parameter Setting*.
- When RBW < 30 kHz, the analyzer starts to perform FFT sweep. At this time, "Sweep Time" menu is disabled and grayed out.

Parameter	Remarks
Default	1 ms
Range ^[1]	1 ms to 4,000 s
Unit	s, ms, μ s, ns, ps
Knob Step	sweep time/100, Min = 1 μ s
Left/Right Arrow Key Step	at 1-1.5-2-3-5-7.5 step

NOTE

[1]: In non-zero span mode, its range is from 1 ms to 4,000 s.



5.2.2.3 Sweep Time Mode

Sets the "Sweep Time" to be "Auto" or "Manual". By default, it is "Auto".

Key Points:

- In non-zero span mode, the analyzer selects the shortest sweep time based on the current RBW and VBW settings if "Auto" is selected.
- Decreasing the sweep time can speed up the measurement. However, an error may be caused if the set sweep time is less than the minimum sweep time in Auto coupling. At this point, "UNCAL" is shown in the status bar on the screen.
- In zero span mode, the "Sweep Time Mode" menu is disabled and grayed out. When the system exits the zero span mode, the auto sweep coupling mode will restore to its state prior to zero span mode.
- When $RBW < 30$ kHz, the analyzer starts to perform FFT sweep. At this time, "Sweep Time Mode" menu is disabled and grayed out.

5.2.2.4 Sweep Time Rules

Sets the sweep rules to "Normal" or "Accurate". The sweep will be faster if "Normal" is selected; while in "Accurate" type, a higher measurement precision can be obtained.

5.2.2.5 Sweep Type

Sets the sweep type to "Sweep" or "FFT".

In FFT sweep mode, when $RBW \geq 30$ kHz, the sweep mode automatically changes to Sweep.

5.2.2.6 Sweep Type Mode

Sets the "Sweep Type Mode" to be "Auto" or "Manual". By default, it is "Auto".

In Auto mode, when $RBW \leq 30$ kHz, the instrument automatically selects FFT sweep.

5.2.2.7 Sweep Mode

RSA6000 series spectrum analyzer supports two sweep modes: Single sweep and Continuous sweep.

Continuous Sweep

- If the current system is in single sweep mode and no measurement is performed, click or tap **Sweep** > **Sweep Mode** > **Cont** to enter continuous sweep mode. In this case, if the trigger conditions are met, the system will sweep continuously.
- If the current system is in single sweep mode and is performing the specified measurement, click or tap **Sweep** > **Sweep Mode** > **Cont** to enter continuous sweep mode. In this case, if the trigger conditions are met, the system will perform measurements continuously.
- In continuous sweep mode, the system will send a trigger initialization signal automatically and enter the trigger condition judgment directly after each sweep is completed.

Single Sweep

- If the current system is in continuous sweep mode and no measurement is performed, selecting this menu to enter the single sweep mode. In this case, if the trigger conditions are met, the system performs one sweep
- If the current system is in continuous sweep mode and is performing the specified measurement, selecting this menu to set the measurement mode to "Single". In this case, if the trigger conditions are met, the system will execute the specified number of measurements.
- If the system is already in single sweep mode, press this key and then the system will execute the specified number of sweeps (or measurements) once the trigger conditions are met.
- In single sweep mode, trigger initialization (click or tap **Sweep** > **Sweep Mode** > **Cont** or send the SCPI command through the remote interface) should be executed before judging the trigger conditions.



NOTE

Switching between Single and Continuous sweep mode will result in restarting the sweep.

5.2.2.8

Restart

Click or tap **Restart**, the current sweep will be suspended. All the previously measured data will be remeasured, and the trigger restores to the not-triggered state.

5.2.3 Trigger

Selects the trigger source and sets trigger-related parameters.

5.2.3.1 Trigger Source

Sets "Free Run", "External", or "Video" to be the trigger source.

1. Free Run

The trigger conditions are met at any time, that is, the analyzer generates trigger signals continuously.

2. External

In this mode, an external signal is input via the **[TRIG IN]** connector on the rear panel. When the signal meets the set trigger conditions, trigger signals are generated.

3. Video

A trigger signal will be generated when the system detects a video signal whose voltage exceeds the specified video trigger level.

NOTE

The Video trigger is unavailable to choose in the following conditions:

- in non-zero span mode;
- when you select "RMS Average" or "Volt Average" detector type in zero span mode.

5.2.3.2 Slope

Sets the trigger polarity for External Trigger. To trigger on a rising edge, set it to Positive; to trigger on a falling edge, set it to Negative.

5.2.3.3 Delay State

Enables or disables the trigger delay function. After the trigger delay function is enabled, you can set the trigger delay time.

5.2.3.4 Delay Time

Sets the time interval during which the instrument waits to start the sweep operation after the trigger signal that meets the trigger conditions is generated. You can use the numeric keys, the knob, and the arrow keys on the front panel to modify this parameter; also you can modify it on the touchscreen. For details, refer to descriptions in *Parameter Setting*.

Parameter	Remarks
Default	1 μ s
Range	0 μ s to 500 ms
Unit	s, ms, μ s, ns, ps
Knob Step	trigger delay/100, Min = 1 μ s
Left/Right Arrow Key Step	at 1-1.5-2-3-5-7.5 step

5.2.3.5 Trigger Level

Sets the trigger level in video trigger. At this time, the trigger level line and the trigger level value are displayed on the screen.

Key Points:

- When the video trigger signal is not within the display range, the trigger level line is displayed at the top or bottom of the waveform display area.
- You can use the numeric keys, the knob, and the arrow keys on the front panel to modify this parameter; also you can modify it on the touchscreen. For details, refer to descriptions in *Parameter Setting*.

Parameter	Remarks
Default	-25 dBm
Range	-140 dBm to 25 dBm
Unit ^[1]	dBm
Knob Step	1 dB
Left/Right Arrow Key Step	10 dB



NOTE

[1]: It is related to the currently selected Y-axis unit.

5.2.3.6 Trigger Holdoff State

Turns on or off the trigger holdoff function.

5.2.3.7 Trigger Holdoff

Sets the holdoff time between trigger signals. You can use the numeric keys, the knob, and the arrow keys on the front panel to modify this parameter; also you can modify it on the touchscreen. For details, refer to descriptions in *Parameter Setting*.

When the trigger conditions are met, the trigger occurs. Then, the delay begins, and the holdoff time begins. During the holdoff time, new trigger signals will be ignored. For a free-running trigger, the holdoff value is the minimum time between two trigger signals.

Parameter	Remarks
Default	100 ms
Range	100 μ s to 500 ms
Unit	s, ms, μ s, ns, ps
Knob Step	trigger holdoff time/100, Min = 1 μ s
Left/Right Arrow Key Step	at 1-1.5-2-3-5-7.5 step

5.2.3.8 Auto Trig Switch

Enables or disables the auto trigger function.

5.2.3.9 Auto Trig

Sets the time that the instrument will wait for the trigger conditions to be met. When the set waiting time times out, the instrument will not wait and start to initiate the sweep measurement.

Parameter	Remarks
Default	100 ms
Range	1 ms to 100 s
Unit	s, ms, us, ns, ps
Knob Step	auto trigger time/100, Min = 1 us
Left/Right Arrow Key Step	at 1-1.5-2-3-5-7.5 step

The relationship of the trigger parameters is shown in the following figure.

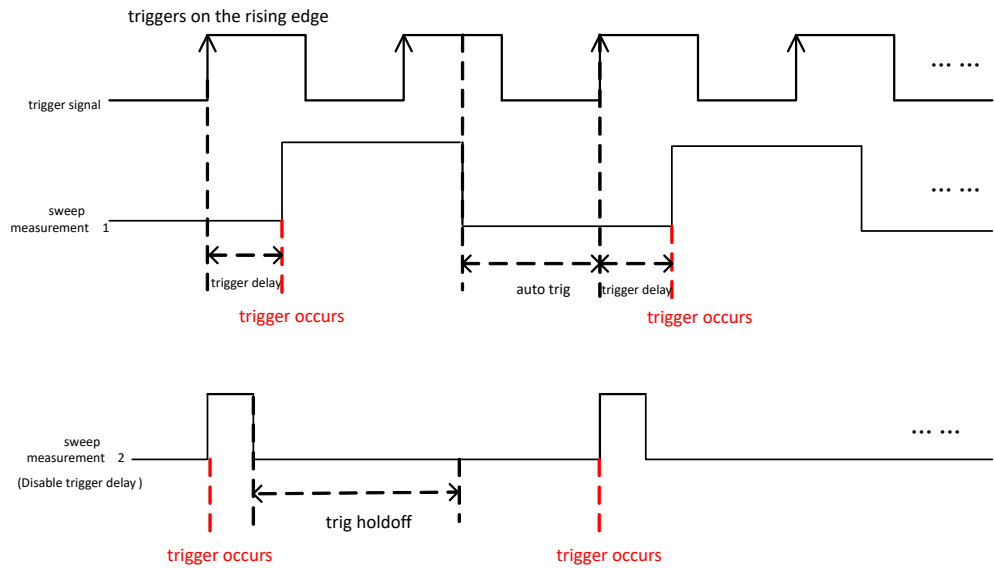

Figure 5.1 Relationship of Trigger Parameters

5.2.4 Trace

Displays the sweep signal on the screen. Press **Trace** to enter the Trace menu. You can set Trace-related parameters.

5.2.4.1 Selected Trace

RSA6000 can display at most 6 traces synchronously. Each trace is indicated in different colors (Trace1-yellow, Trace2-dark blue, Trace3-green, Trace4-purple, Trace5-light blue, Trace6-orange). For details, refer to the notes about *trace indicator* in *User Interface*.

Select the corresponding trace to set the relevant parameters for the specified trace. By default, Trace1 is selected, and the trace type is "Clear Write".



NOTE

The trace currently displayed on the screen can be saved to the internal or external memory. If needed, you can recall it at any time. For details about file saving, refer to descriptions in *Save*.

5.2.4.2 Trace Type

Sets the type of the currently selected trace. The system calculates the sweep data in the specified operation method according to the selected trace type. The results will not be displayed unless you set "Trace Update" and "Trace Display" to "ON". Trace types include Clear Write, Average, Max Hold, and Min Hold.

1. Clear Write

Sets the trace data to a minimum value, and displays the real-time sweep data of each point on the trace.

2. Average

Displays an average trace, which is represented by averaging the data of each point on the trace. The type of the trace is displayed to be smooth.

3. Max Hold

Maintains and displays a max hold trace, which represents the maximum data value on a point-by-point basis. When a new maximum value is generated, data will be updated, and the newly updated maximum value prevails.

4. Min Hold

Maintains and displays a min hold trace, which represents the minimum data value on a point-by-point basis. When a new minimum value is generated, data will be updated, and the newly updated minimum value prevails.

5.2.4.3 Detector Type

Sets the detector for the current measurement. The selected detector can be applied to the selected trace. The available trace detectors include Pos Peak, Neg Peak, Normal, Sample, Volt Average, Quasi-Peak, RMS Average, and C-RMS-Average.

1. Pos Peak

For each trace point, Positive Peak detector displays the maximum value of data sampled within the corresponding time interval.

2. Neg Peak

For each trace point, Negative Peak detector displays the minimum value of data sampled within the corresponding time interval.

3. Normal

Normal detector (also called Rosenfell detector) displays the maximum value and the minimum value of the sample data segment in alternating sequence. That is, for an odd-numbered data point, the minimum value of the sample data is displayed; for an even-numbered data point, the maximum value of the sample data is displayed. In this way, the amplitude variation range of the signal is clearly shown.

4. Sample

For each trace point, Sample detector displays the transient level corresponding to the central time point of the corresponding time interval. This detector type is applicable to noise or noise-like signal.

5. Volt Average

For each data point, average (see equation below) all the sampled data within the corresponding time interval and display the result.

$$V_{AV} = \frac{1}{N} \times \sum_{i=1}^N v_i$$

Wherein, V_{AV} is the average of voltage in V; N is the number of sampled values for each point displayed; v_i is the envelope of the sampled value in V.

6. Quasi-Peak

It is a weighted form of peak detector. For each data point, the detector detects the peaks within the corresponding time interval. The peaks detected are weighted using circuit with specified charge and discharge structures as well as the display time constant specified in the CISPR 16 standards and the result is displayed. Quasi-Peak detector is applicable to EMC testing.

NOTE

Compared with the discharge time, the charge time of Quasi-Peak detector is much shorter and can reflect the amplitude as well as time distribution of the signal.

7. RMS Average

RMS (Root Mean Square) averaging is a processing method used to smooth spectral data and accurately reflect the average power of the signal. For each data point, perform mean square root operation (see equation below) of the sampled data within the corresponding time interval and display the result. RMS average only refers to the RMS data in the Gaussian filter.

$$V_{RMS} = \sqrt{\frac{1}{N} \times \sum_{i=1}^N v_i^2}$$

Wherein, V_{RMS} is the root mean square value of voltage, expressed in V; N is the number of sampled values for each point displayed; v_i is the envelope of the sampled value, expressed in V. Reference impedance R can be used to calculate

power based on the formula: $P = \frac{V_{RMS}^2}{R}$.

8. C-RMS-Avg

The C-RMS-Average (EMI CISPR RMS) detector combines an RMS calculation within the channel bandwidth and multiple averaging process, primarily used to improve the accuracy and stability of signal power measurements.

NOTE

C-RMS Average specifically refers to the C-RMS data in EMI filter.

When you select the C-RMS-Average detector (if the filter is not EMI) manually, the instrument switches to the EMI filter automatically.

5.2.4.4 Detector Auto

Enables or disables the Detector Auto function. By default, Detector Auto is enabled. If you set the detector type manually, please disable the Detector Auto function.

5.2.4.5 Trace Update

Enables or disables trace update.

5.2.4.6 Trace Display

Enables or disables the trace display.

Key Points:

- The trace state and the parameter settings for the corresponding state are as follows:
 - Active: Trace Update and Trace Display are "ON".
 - View: Trace Update is "OFF", and Trace Display is "ON".
 - Clear: Trace Update and Trace Display are "OFF".
 - Back-end: Trace Update is "ON", and Trace Display is "OFF".
- In most cases, the inactive trace data keep unchanged. However, the data may be changed in the following conditions:
 - Remote write data into trace;
 - Load the stored data to trace.
 - Trace data are cleared by the trace clear function.
- When inactive trace is displayed, the trace will not be zoomed in or out based on the setting of X-axis, but will move up and down based on the changes of Y-axis values.
- When the trace is shifted from inactive to active state, the trace is cleared, the average timer is reset, and a new sweep is restarted.

5.2.4.7 Math Function

Trace math functions perform mathematical operations between traces and, in some cases, user-defined offsets.

1. Op1 - Op2

Calculates the power difference between Operand 1 (Op1) and Operand 2 (Op2), and saves it to the destination trace. During the sweep, the following formula is executed for each point:

$$Trace_{result} = 10\log(10^{(Op1/10)} - 10^{(Op2/10)})$$

In the above formula, the parameter unit is dBm. If a point in Op1 is a maximum trace value, the difference (the result of the subtraction) is also a maximum trace value; if the difference is less than or equal to 0, the resultant point is the minimum trace value.

2. Op1 + Op2

Calculates the power sum between Operand 1 (Op1) and Operand 2 (Op2), and saves it to the destination trace. During the sweep, the following formula is executed for each point:

$$Trace_{result} = 10\log(10^{(Op1/10)} + 10^{(Op2/10)})$$

In the above formula, the parameter unit is dBm. If a point in Op1 or Op2 is a maximum trace value, the sum (the result of addition) is also a maximum trace value.

3. Op1 + Offset

Calculates the sum between Operand 1 (Op1) and Offset, and saves it to the destination trace. During the sweep, the following formula is executed for each point:

$$Trace_{result} = Op1 + Offset$$

In the above formula, the parameter unit is dBm.

4. Op1 - Offset

Calculates the the difference between Operand 1 (Op1) and Offset (Offset), and saves it to the destination trace. During the sweep, the following formula is executed for each point:

$$Trace_{result} = Op1 - Offset$$

In the above formula, the parameter unit is dBm.

5. Op1 - Op2 + Ref

Operand 1 (Op1) minus Operand 2 (Op2), and then plus the reference value (Reference). Then, saves the result to the destination trace. During the sweep, the following formula is executed for each point:

$$Trace_{result} = Op1 - Op2 + Reference$$

In the above formula, the unit for Op1, Op2, and Reference is dBm.

6. Off

Disables the math function.



NOTE

The trace math functions are mutually exclusive. If you apply one math operation to a certain trace, the last selected math operation function will be disabled.

5.2.4.8 Op1

Selects Operand 1 to be used for the trace math functions. Operand 2 can be configured with Trace1, Trace2, Trace3, Trace4, Trace5, or Trace6.

5.2.4.9 Op2

Selects Operand 2 to be used for the trace math functions. Operand 2 can be configured with Trace1, Trace2, Trace3, Trace4, Trace5, or Trace6.



NOTE

The currently displayed trace does not involve in the math operation.

5.2.4.10 Offset

Sets the log offset in the math operation function. The unit is dB.

Parameter	Remarks
Default	0 dB
Range	-100 dB to 100 dB
Unit	dB
Knob Step	1 dB
Left/Right Arrow Key Step	10 dB



NOTE

This menu is only valid when you select "Op1+Offset" or "Op1-Offset" to be the math function.

5.2.4.11 Reference

Sets the log reference difference in the math operation function. The unit is dBm.

Parameter	Remarks
Default	0 dBm
Range	-170 dBm to 30 dBm
Unit	dBm
Knob Step	1 dBm
Left/Right Arrow Key Step	5 dBm



NOTE

This menu is only valid when you select the "Op1 – Op2 + Ref" operation function.

5.2.4.12 Preset All

Turns on Trace 1, and blanks all other traces. This operation does not affect the trace type, trace detector, and other states.

5.2.4.13 Clear All Traces

Clears all traces. All the trace data will be set to the minimum trace value (except the case that the trace is in Min Hold state). When the trace is in Min Hold state, the trace data will be set to the maximum trace value. That is, even if you turn off the trace update, the trace data will be updated after you perform the "Clear All" operation.

5.2.5 TG (Option)

To enable the TG function, purchase the RSA6000-T08 option. For the procedures of installing the option, refer to descriptions in *To View the Option and the Option Installation*.

After installing the TG option, click or tap the measurement mode label at the bottom of the screen to enter the mode switching interface. Then select the TG measurement.



Figure 5.2 Measurement Setting Interface

5.2.5.1 TG

Enables or disables the tracking generator.

When the tracking generator is enabled, a signal with the same frequency of the current sweep signal will be output from the **[Gen Output 50Ω]** connector on the front panel. The power of the signal can be set through the menu.

5.2.5.2 Amplitude

Sets the output power of the TG signal.

You can use the numeric keys, the knob, and the arrow keys on the front panel to modify this parameter; also you can modify it on the touchscreen. For details, refer to descriptions in *Parameter Setting*.

Parameter	Remarks
Default	-40 dBm
Range	-40 dBm to 0 dBm
Unit	dBm, -dBm, mV, uV
Knob Step	1 dB
Left/Right Arrow Key Step	10 dB

5.2.5.3 Amplitude Offset

Sets an offset from the output power of the TG when gains or losses occur between the TG output and external device to display the actual power value.

Key Points:

- This parameter only changes the readout of the TG output power, rather than the actual output power.
- The offset could be either a positive (gain in the external output) or a negative (loss in the external output) value.
- You can use the numeric keys, the knob, and the arrow keys on the front panel to modify this parameter; also you can modify it on the touchscreen. For details, refer to descriptions in *Parameter Setting*.

Parameter	Remarks
Default	0 dB
Range	-200 dB to 200 dB
Unit	dB
Knob Step	1 dB
Left/Right Arrow Key Step	10 dB

5.2.5.4 Normalize

Before enabling the normalize function, connect the TG output terminal [**Gen Output 50Ω**] to the RF input terminal [**RF Input 50Ω**]. Normalization can eliminate the error of TG output amplitude.

NOTE

Only when Output under the TG menu is "ON" and the current Y-axis scale is log, can the Normalize menu be enabled.

1. Normalize

Enables or disables the normalize function. If no saving operation is performed on the reference trace before enabling the normalize function, the next time you enable the function, the analyzer will save the reference trace automatically after it completes the current sweep. During saving the reference trace, a prompt message will be displayed. When the normalize function is enabled, the

corresponding value of the reference trace will be subtracted from the trace data after every sweep.

2. Ref Value

After the normalize function is enabled, you can adjust the vertical position of the trace on the screen by adjusting the reference level.

- Different from the Ref Level sub-menu under "Amplitude", the modification of the parameter "Ref Value" under "Normalize Setting" menu will not affect the reference level of the analyzer.
- You can use the numeric keys, the knob, and the arrow keys on the front panel to modify this parameter; also you can modify it on the touchscreen. For details, refer to descriptions in *Parameter Setting*.

Parameter	Remarks
Default	0 dB
Range	-200 dB to 200 dB
Unit	dB
Knob Step	1 dB
Left/Right Arrow Key Step	10 dB

3. Ref Position

After the normalize function is enabled, you can adjust the normalized vertical position on the screen by adjusting the reference position.

- The function of this menu is similar to that of Reference Level. When it is set to 0%, the normalized ref position is at the bottom of the graticule and at the top line of the graticule when it is set to 100%.
- You can use the numeric keys, the knob, and the arrow keys on the front panel to modify this parameter; also you can modify it on the touchscreen. For details, refer to descriptions in *Parameter Setting*.

Parameter	Remarks
Default	100%
Range	0% to 100%

Parameter	Remarks
Unit	%
Knob Step	1%
Left/Right Arrow Key Step	10%

4. Reference Trace

Sets whether to display the reference trace. If you set "Reference Trace" to be "On", the reference trace saved (Trace 6) will be shown.

5. Save Ref Trace

Saves the data of Trace1 to Trace6 as the reference value for normalization. This operation should be done before you enable the normalize function.

5.3 Measurement Settings

5.3.1 Meas Setup

RSA6000 series spectrum analyzer provides swept SA function and multiple advanced measurement functions, such as time-domain power, adjacent channel power, multi-channel power, occupied bandwidth, C/N ratio, harmonic distortion, TOI, and etc.

Advanced measurement is an option for RSA6000, and the advanced functions are only available when the advanced measurement kit (AMK) has been installed. When you enable the measurement function, the screen is divided into two windows (measurement result window and trace window).

5.3.1.1 Swept SA Measurement

Press  on the front panel or click/tap **Meas Setup** to set the corresponding parameters for swept SA.

Measure Setup

- **Average Number**

Specifies the number of average counts (N) for Average, Max Hold, and Min Hold. For Average, the greater the value of N, the smoother the trace is displayed.

In Average, Max Hold, and Min Hold modes, when performing the single measurement, the instrument stops sweeping after the sweep count has reached N.

Parameter	Remarks
Default	100
Range	1 to 10,000
Unit	None
Knob Step	1
Left/Right Arrow Key Step	1

- Average Type

Selects the average type to "Log", "RMS", or "Scalar".

- **Log:** In this mode, all filtering and averaging processes select the log unit (dB). This average type is the most effective one for finding the low-level signal that is close to the noise amplitude. The formula is shown as follows:

$$NewAvg = \frac{(k - 1) \times OldAvg + Newdata}{k}$$

In the above formula, the parameter unit is dB.

- **RMS:** In this mode, all filtering and averaging processes work on the power (the square of the amplitude) of the signal. This average type is best for measuring the true time average power of complex signals. As the voltage result is in proportion to the square root of the average of the square of the voltage, it is also called the root mean square. The formula is shown as follows:

$$NewAvg = 10 \log \left(\frac{(k - 1) \times 10^{\frac{OldAvg}{10}} + 10^{\frac{Newdata}{10}}}{k} \right)$$

In the above formula, the parameter unit is dB.

- **Scalar:** In this mode, all filtering and averaging processes work on the voltage envelope of the signal. This average type is the most appropriate one for observing the great envelope fluctuations of AM or pulse-

modulated signals such as radar and TDMA transmitters. The formula is shown as follows:

$$NewAvg = 20\log \left(\frac{(k - 1) \times 10^{\frac{OldAvg}{20}} + 10^{\frac{Newdata}{20}}}{k} \right)$$

In the above formula, the parameter unit is dB.

- **Average Auto**

Enables or disables the auto average function. When the auto average function is enabled, the instrument will select the best average type based on the current settings. When you select one of the average types manually, the instrument will apply the selected type, and the auto average function is disabled automatically.

- **Auto Couple**

When you enable "Auto Couple" function, all the manual/auto settings in the current measurement mode will be set to "Auto". This operation does not affect other measurement modes.

In auto state, the auto coupled parameters are changed with their coupled parameters. The auto coupling operation will ensure the optimal performance of the instrument. After the operation, all the auto coupled parameters will immediately be automatically reset based on the coupled parameters.

Limit

Sets the parameters of limit lines. After you click or tap **Preset**, the limit line measurement function is disabled, but the data of the limit lines will be reserved. The limit line data will only be cleared when you set the power on state to Preset. When you exit the measurement mode, the limit line data will not be cleared.

- **Test Limits**

Selects whether the displayed traces are tested against the displayed limit lines. For each displayed trace, the corresponding limit line is turned on, and a message will be displayed at the upper-left corner of the trace to indicate whether the test passes or fails.

- **Select Limit**

Selects the current limit line. By default, it is Limit1.

- **Limit State**

Enables or disables the display of the limit line. When the limit line is on, the measurement interface displays the limit line, and the corresponding traces are

tested based on the current limit lines. Each limit line is displayed in different colors.

- **Edit Limit**

When "Limit State" is set to "ON", this menu is valid. Click or tap **Edit Limit** to enter the limit editing interface. Then, the current limit line will be turned on. Close the peak table, and open the trace that corresponds to the limit line.

- **Select Limit:** Selects the current limit line. By default, it is Limit1.
- **Append Point:** Adds an edit point.
- **X Offset:** Sets the frequency offset of the current limit line.
- **Y Offset:** Sets the amplitude offset of the current limit line.
- **Apply Offset:** Adds the X and Y offsets to each point of the current limit line.
- **X To CF:** When "Fixed" is selected, the frequency of the current editing point will not be affected by the center frequency. When "Relative" is selected, the frequency of the current editing point is the difference between the frequency of the point and the current center frequency. At this time, if the center frequency changes, then the position of the current editing point changes along with the center frequency.
- **Y To RF:** When "Fixed" is selected, the amplitude of the current editing point will not be affected by the reference level. When "Relative" is selected, the amplitude of the current editing point is the difference between the amplitude of the point and that of the current reference level. At this time, if the reference level changes, then the position of the current editing point changes along with the reference level.
- **Build From:** Sets a trace for building the limit line. The range is from Trace1 to Trace6.
- **Copy From:** Copies from the selected limit line to the current limit line. The range is from Limit1 to Limit6.
- **Delete Point:** Deletes the point that you are editing.
- **Delete Limit:** Deletes the limit line you are editing.

- **Type:** Selects the type of the current limit line to be "Upper" or "Lower". If the trace amplitude is greater than the amplitude of the upper limit line and smaller than that of the lower limit line, then the test fails.
- **Limit Test Trace:** Sets the trace for the current limit line test. The range is from Trace1 to Trace6.
- **Freq Interpolation:** Sets the frequency interpolation for the current limit line to "Linear" or "Log".
- **Ampt Interpolation:** Sets the amplitude interpolation for the current limit line to "Linear" or "Log".
- **Margin State:** Enables or disables the display of the margin. When you enable the display of the margin, the measurement interface displays the margin lines; when you disable the display of the margin, the margin is invalid.
- **Margin:** Sets the margin for the current limit line.
- **Description:** Adds the descriptions for the limit line.
- **Comment:** Adds the annotations for the limit line.

TIP

You can touch any point in the trace display view on the screen to edit the current point to be the limit line data point. You can also drag the point to adjust the position of the current edit point, that is, to change the frequency/amplitude of the current point.

- **Import Limit**

Click or tap **Import Limit**, then the file management interface is displayed. You can select the desired file to be imported.

- **Export Limit** Click or tap **Export Limit**, then the file management interface is displayed. You can select the desired file to be exported.

- **Delete All Limits**

Deletes all limit lines. After you click or tap this menu, the data of all the limit lines will be cleared and they will be restored to factory defaults.

Global CF Mode

You can press **Meas Setup** > **Global**, or click/tap **Meas Setup** > **Global** to enter the global setting menu of the current working mode.

1. Global CF Mode

Turns on or off the global center frequency. In any working mode, if you enable the global center frequency mode, then the global center frequency will be set to the center frequency of the current mode. When a different working mode is selected, the global center frequency will be set to the center frequency of the previous working mode, that is, the one that is before switching the working mode. If you change the center frequency in any working mode, then the global center frequency will change with it.

2. Global CF

Sets the global center frequency. It is only available when you enable the global CF mode.

5.3.1.2 ACP

After selecting the ACP measurement item, the instrument measures the power of the main channel, the power of adjacent channels, and the power difference between the main channel and each of the adjacent channels. When this function is enabled, the span and resolution bandwidth of the analyzer will be adjusted to smaller values automatically.



Figure 5.3 ACP Measurement Interface

Test Result

The test results include main channel power, upper-adjacent channel power, and lower-adjacent channel power.

- Main channel power: displays the power within the bandwidth of the main channel.
- Upper: displays the power of the upper channel and the power difference between the upper channel and the main channel (in dBc).
- Lower: displays the power of the lower channel and the power difference between the lower channel and the main channel (in dBc).

Measurement Parameter

Measurement parameters include average count, average mode, average state, main channel bandwidth, adjacent channel bandwidth, and channel spacing.

1. Average Number

Specifies the number of times for averaging the measurement results. You can use the numeric keys, the knob, or arrow keys to modify this parameter; you can also use the touch screen to modify the parameter.

Parameter	Remarks
Default	10
Range	1 to 1,000
Unit	None
Knob Step	1
Left/Right Arrow Key Step	1

2. Average Mode

Sets the average mode to "Exponential" or "Repeat". The default average mode is "Exponential".

- When "Exponential" is selected, the result is the exponential average of the measurement results obtained in the past N times (N is specified in "*Average Number*").
- When "Repeat" is selected, the result is the arithmetic average of the measurement results obtained in the past N times (N is specified in "*Average Number*").

3. Average State

Sets whether to averaging the measurement results. By default, it is enabled.

4. MainChanBW

Sets the bandwidth of the main channel, and the power of the main channel is the power integral within this bandwidth. You can use the numeric keys, the knob, or arrow keys to modify this parameter; you can also use the touch screen to modify the parameter.

Parameter	Remarks
Default	2 MHz
Range	3 Hz to $S_{max}/3$
Unit	GHz, MHz, kHz, Hz
Knob Step	main channel bandwidth/100, Min = 1 Hz
Left/Right Arrow Key Step	at 1-1.5-2-3-5-7.5 step

5. AdjChanBW

Sets the frequency width of the adjacent channels.

- The adjacent channel bandwidth is related to the main channel bandwidth, and the settable range is from (main channel bandwidth/20) to (main channel bandwidth x 20).
- You can use the numeric keys, the knob, or arrow keys to modify this parameter; you can also use the touch screen to modify the parameter.

Parameter	Remarks
Default	2 MHz
Range	3 Hz to $S_{max}/3$
Unit	GHz, MHz, kHz, Hz
Knob Step	adjacent channel bandwidth/100, Min = 1 Hz
Left/Right Arrow Key Step	at 1-1.5-2-3-5-7.5 step

6. Chan Spacing

Sets the spacing between the center frequency of the main channel and that of the adjacent channels.

- Adjusting this parameter will also adjust the distance between the upper/lower channel and the main channel.
- You can use the numeric keys, the knob, or arrow keys to modify this parameter; you can also use the touch screen to modify the parameter.

Parameter	Remarks
Default	2 MHz
Range	3 Hz to $S_{max}/3$
Unit	GHz, MHz, kHz, Hz
Knob Step	channel spacing/100, Min = 1 Hz
Left/Right Arrow Key Step	at 1-1.5-2-3-5-7.5 step



NOTE

Smax indicates the Max. span in non-zero mode.

5.3.1.3

C/N Ratio (CNR)

In the GPSA measurement setting interface, select the C/N Ratio measurement item, and then you can measure the power of the carrier and that of the noise with the specified bandwidth, as well as their power ratio.

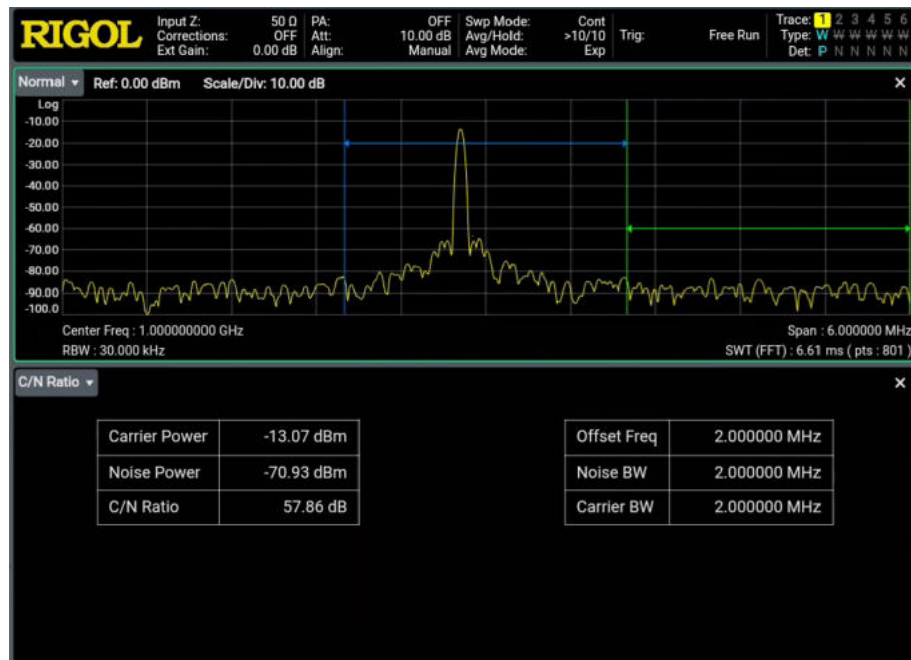

Figure 5.4 C/N Ratio Measurement Interface

Test Result

Carrier power, noise power, and C/N ratio.

- Carrier Power: power within the carrier bandwidth.
- Noise Power: power within the noise bandwidth.
- C/N Ratio: the ratio of the carrier power to the noise power.

Measurement Parameter

Measurement Parameters: average count, average mode, average state, offset frequency, noise BW, and carrier bandwidth.

1. Average Number

Specifies the number of times for averaging the measurement results. You can use the numeric keys, the knob, or arrow keys to modify this parameter; you can also use the touch screen to modify the parameter.

Parameter	Remarks
Default	10
Range	1 to 1,000
Unit	None
Knob Step	1
Left/Right Arrow Key Step	1

2. Average Mode

Sets the average mode to "Exponential" or "Repeat". The default average mode is "Exponential".

- When "Exponential" is selected, the result is the exponential average of the measurement results obtained in the past N times (N is specified in "*Average Number*").
- When "Repeat" is selected, the result is the arithmetic average of the measurement results obtained in the past N times (N is specified in "*Average Number*").

3. Average State

Sets whether to averaging the measurement results. By default, it is enabled.

4. Offset Frequency

Sets the difference between the center frequency of the carrier and that of the noise. You can use the numeric keys, the knob, or arrow keys to modify this parameter; you can also use the touch screen to modify the parameter.

Parameter	Remarks
Default	2 MHz
Range	3 Hz to $S_{\max}/3$
Unit	GHz, MHz, kHz, Hz
Knob Step	offset frequency/100, Min = 1Hz
Left/Right Arrow Key Step	at 1-1.5-2-3-5-7.5 step

5. Noise Bandwidth

Sets the bandwidth of the noise to be measured. You can use the numeric keys, the knob, or arrow keys to modify this parameter; you can also use the touch screen to modify the parameter.

Parameter	Remarks
Default	2 MHz
Range	3 Hz to $S_{\max}/3$
Unit	GHz, MHz, kHz, Hz
Knob Step	noise BW/100, Min = 1 Hz
Left/Right Arrow Key Step	at 1-1.5-2-3-5-7.5 step

6. Carrier Bandwidth

Sets the bandwidth of the carrier to be measured.

- The carrier bandwidth is related to the noise bandwidth, and the settable range is from (noise bandwidth/20) to (noise bandwidth x 20).
- You can use the numeric keys, the knob, or arrow keys to modify this parameter; you can also use the touch screen to modify the parameter.

Parameter	Remarks
Default	2 MHz

Parameter	Remarks
Range	3 Hz to $S_{max}/3$
Unit	GHz, MHz, kHz, Hz
Knob Step	carrier noise/100, Min = 1 Hz
Left/Right Arrow Key Step	at 1-1.5-2-3-5-7.5 step



NOTE

Smax indicates the Max. span in non-zero mode.

5.3.1.4

Channel Power

After selecting "Chan Pwr" (channel power) measurement, the instrument measures the channel power and power density of the specified channel bandwidth.

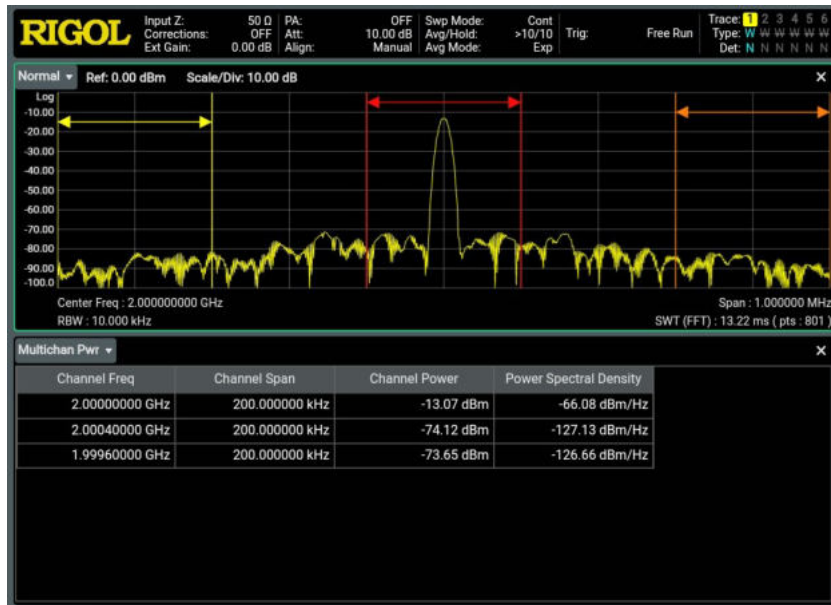

Figure 5.5 Channel Power Measurement Interface

Test Result

Channel power and power spectral density.

- Channel Power: power within the channel span.
- Power Spectral Density: power (in dBm/Hz) normalized to 1 Hz within the channel span.

Measurement Parameter

Measurement parameters include average count, average mode, average state, channel frequency and channel span.

1. Average Number

Specifies the number of times for averaging the measurement results. You can use the numeric keys, the knob, or arrow keys to modify this parameter; you can also use the touch screen to modify the parameter.

Parameter	Remarks
Default	10
Range	1 to 1,000
Unit	None
Knob Step	1
Left/Right Arrow Key Step	1

2. Average Mode

Sets the average mode to "Exponential" or "Repeat". The default average mode is "Exponential".

- When "Exponential" is selected, the result is the exponential average of the measurement results obtained in the past N times (N is specified in "*Average Number*").
- When "Repeat" is selected, the result is the arithmetic average of the measurement results obtained in the past N times (N is specified in "*Average Number*").

3. Average State

Sets whether to averaging the measurement results. By default, it is enabled.

4. Edit Channel

a. Add Channel

- In the channel editing table, if you select a row, then click or tap this menu to add a line with the same parameter values as the selected row.

- In the channel editing table, if no row is selected, click or tap this menu, then a channel whose center frequency equals to the channel frequency value and whose bandwidth equals to the channel span value is added.

Notice

When the channel editing table is disabled, the add channel operation is still valid.

b. Delete Channel

Click or tap this menu to delete the currently selected channel.

Note that if the channel editing table is disabled or no channel is selected, then the deleting operation is invalid.

c. Delete All Channels

Click or tap this menu to clear data in the channel editing table, i.e., deleting all the channels.

NOTE

When the channel editing table is disabled, the deleting all channels operation is still valid.

5.3.1.5 Third-order Intercept (TOI)

After selecting TOI measurement, the analyzer can measure the third-order intercept (TOI) of a two-tone signal (with the same amplitude and similar frequency), including the frequencies and amplitudes of Lower Tone, Upper Tone, Lower 3rd TOI, and Upper 3rd TOI, as well as the intercept points of both the Lower 3rd TOI and Upper 3rd TOI.

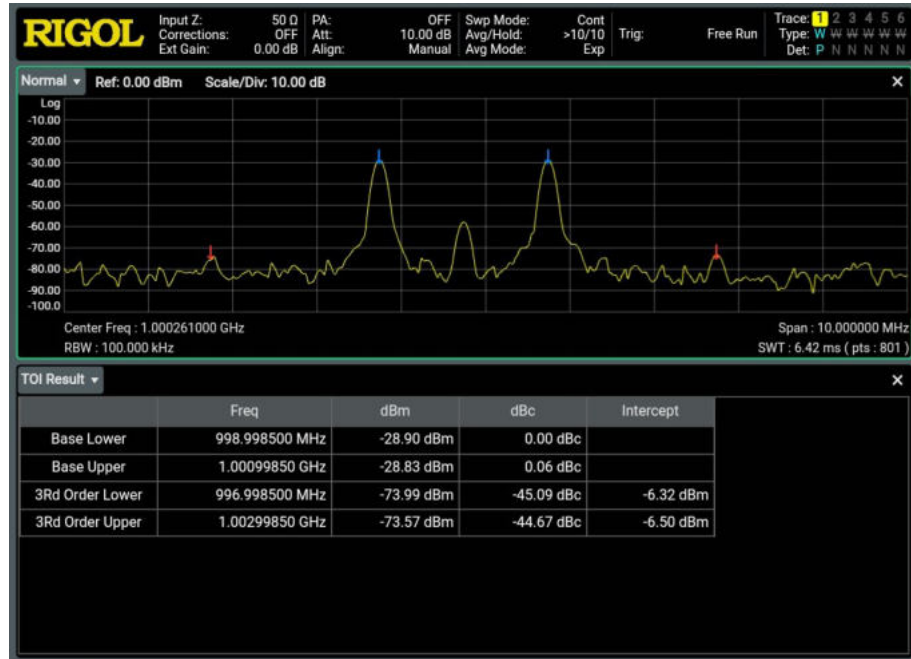

Figure 5.6 TOI Distortion Measurement Interface

Test Result

Frequency and amplitude of four signals (Base Lower, Base Upper, 3rd Order Lower, 3rd Order Upper), the amplitude difference between each signal and the base lower signal, as well as the 3rd order intercept point (Intercept) of the base lower signal and base upper signal.

3rd order lower intercept point = (power of base lower signal - power of 3rd order lower signal) + power of base lower signal; 3rd order upper intercept point = (power of base upper signal - power of 3rd order upper signal)/2 + power of base upper signal.

Measurement Parameter

Measurement Parameters: average count, average mode, average state, and span.

1. Average Number

Specifies the number of times for averaging the measurement results. You can use the numeric keys, the knob, or arrow keys to modify this parameter; you can also use the touch screen to modify the parameter.

Parameter	Remarks
Default	10
Range	1 to 1,000
Unit	None

Parameter	Remarks
Knob Step	1
Left/Right Arrow Key Step	1

2. Average Mode

Sets the average mode to "Exponential" or "Repeat". The default average mode is "Exponential".

- When "Exponential" is selected, the result is the exponential average of the measurement results obtained in the past N times (N is specified in "*Average Number*").
- When "Repeat" is selected, the result is the arithmetic average of the measurement results obtained in the past N times (N is specified in "*Average Number*").

3. Average State

Sets whether to averaging the measurement results. By default, it is enabled.

4. Span

This span is consistent with the span of the spectrum analyzer. It refers to the frequency range of the sweep. After it is set, the span of the spectrum analyzer will be modified accordingly. You can use the numeric keys, the knob, or arrow keys to modify this parameter; you can also use the touch screen to modify the parameter.

Parameter	Remarks
Default	2 MHz
Range	10 Hz to S_{max}
Unit	GHz, MHz, kHz, Hz
Knob Step	TOI distortion span/100, Min = 1 Hz
Left/Right Arrow Key Step	at 1-1.5-2-3-5-7.5 step



NOTE

S_{max} indicates the Max. span in non-zero mode.

5.3.1.6 Harmo Dist (THD)

In the GPSA measurement setting interface, select Harmo Dist measurement item to enter the specified measurement interface. Then you can measure the power of each order of harmonic and THD (total harmonic distortion) of the carrier. The highest order of harmonics for measurement is 10. The fundamental harmonic amplitude of the carrier signal must be greater than -50 dBm; otherwise the measurement will be invalid.



Figure 5.7 Harmonic Distortion Measurement Interface

Test Result

Displays the amplitude of each order of harmonic and THD (total harmonic distortion) of the carrier. At most, 10th-order harmonic can be measured.

Measurement Parameter

The measurement parameters include the average count, average mode, average state, harmonic order, and dwell time.

1. Average Number

Specifies the number of times for averaging the measurement results. You can use the numeric keys, the knob, or arrow keys to modify this parameter; you can also use the touch screen to modify the parameter.

Parameter	Remarks
Default	10
Range	1 to 1,000

Parameter	Remarks
Unit	None
Knob Step	1
Left/Right Arrow Key Step	1

2. Average Mode

Sets the average mode to "Exponential" or "Repeat". The default average mode is "Exponential".

- When "Exponential" is selected, the result is the exponential average of the measurement results obtained in the past N times (N is specified in "*Average Number*").
- When "Repeat" is selected, the result is the arithmetic average of the measurement results obtained in the past N times (N is specified in "*Average Number*").

3. Average State

Sets whether to averaging the measurement results. By default, it is enabled.

4. Harmonics

Sets the number of the harmonics to be measured. It is used to calculate the total harmonic distortion. You can use the numeric keys, the knob, or arrow keys to modify this parameter; you can also use the touch screen to modify the parameter.

Parameter	Remarks
Default	10
Range	2 to 10
Unit	None
Knob Step	1
Left/Right Arrow Key Step	1

5. Range Table

Sets whether the measurement parameter is the fundamental frequency or user-defined measurement frequency. Click or tap "ON" for **Range Table**, the measurement parameter is the user-defined measurement frequency.

6. Edit Range Table

Click or tap **Edit Range Table** to enter the range table editing interface. You can set parameters such as Measure Tone, Frequency, RBW, and Dwell Time.

5.3.1.7 OBW

In the GPSA measurement setting interface, select the OBW measurement item to switch to the OBW measurement interface. You can measure the occupied bandwidth and transmission bandwidth. At this time, you can integrate the power within the whole span and then calculates the bandwidth occupied by this power according to the specified power ratio. You can measure the bandwidth between two points on the signal which are X dB below the highest point within the span.



Figure 5.8 OBW Measurement Interface

Test Result

- Occupied bandwidth and transmit frequency error.
 - Occupied Bandwidth (OBW): Use the integral calculation method to calculate the power within the whole span, and then calculate the bandwidth occupied by the power based on the specified power ratio.
 - Transmit Frequency Error: indicates the difference between the center frequency of the channel and that of the spectrum analyzer.
- Emission Bandwidth (EBW), i.e. the bandwidth between two points on the signal which are X dB below the highest point within the span. During the measurement, the spectrum analyzer first determines the frequency (f_0) of the

max. amplitude point within the span, then searches for the frequency point which is X dB below the amplitude point from f_0 in sequence from left to right. For example, f_1 and f_2 , then EBW is $f_2 - f_1$.

Test Parameter

The measurement parameters include average count, average mode, average state, max hold, span, power ratio, limit value, and EBW X dB.

1. Average Number

Specifies the number of times for averaging the measurement results. You can use the numeric keys, the knob, or arrow keys to modify this parameter; you can also use the touch screen to modify the parameter.

Parameter	Remarks
Default	10
Range	1 to 1,000
Unit	N/A
Knob Step	1
Left/Right Arrow Key Step	1

2. Average Mode

Sets the average mode to "Exponential" or "Repeat". The default average mode is "Exponential".

- When "Exponential" is selected, the result is the exponential average of the measurement results obtained in the past N times (N is specified in "*Average Number*").
- When "Repeat" is selected, the result is the arithmetic average of the measurement results obtained in the past N times (N is specified in "*Average Number*").

3. Average State

Sets whether to averaging the measurement results. By default, it is enabled.

4. Limit State

Enables or disables the limit state. By default, it is OFF.

5. Limit

Sets the limit bandwidth of OBW measurement. Once the set value exceeds the limit, a prompt message will be displayed.

Parameter	Remarks
Default	1.8 MHz
Range	1 kHz to F_{max}
Unit	GHz, MHz, kHz, Hz
Knob Step	span/200
Left/Right Arrow Key Step	

6. Max Hold

Enables or disables max hold. By default, it is "OFF".

- When Max Hold is enabled, each measurement result is compared with the previous result, and then display whichever is the maximum.
- When Max Hold is disabled, the current measurement result is displayed.
- Max Hold and average measurement mode are mutually exclusive. When Max Hold is enabled, the average measurement mode will be automatically disabled.

7. Span

Sets the frequency range of integral calculation. The span is consistent with that of the spectrum analyzer. It is the frequency range of sweep. After it is set, the span of the spectrum analyzer will also be changed. You can use the numeric keys, the knob, or arrow keys to modify this parameter; you can also use the touch screen to modify the parameter.

Parameter	Remarks
Default	2 MHz
Range	10 Hz to S_{max}
Unit	GHz, MHz, kHz, Hz
Knob Step	OBW span/100, Min = 1 Hz
Left/Right Arrow Key Step	at 1-1.5-2-3-5-7.5 step

8. Power Ratio

Sets the percentage the signal power takes up in the whole span power. You can use the numeric keys, the knob, or arrow keys to modify this parameter; you can also use the touch screen to modify the parameter.

Parameter	Remarks
Default	99%
Range	1% to 99.99%
Unit	%
Knob Step	0.01%
Left/Right Arrow Key Step	1%

9. X dB

Sets the value of X dB, which is used in the EBW calculation. You can use the numeric keys, the knob, or arrow keys to modify this parameter; you can also use the touch screen to modify the parameter.

Parameter	Remarks
Default	-10 dB
Range	-100 dB to -0.1 dB
Unit	dB
Knob Step	0.1 dB
Left/Right Arrow Key Step	1 dB



NOTE

Smax indicates the Max. span in non-zero mode.

5.3.1.8 Time-domain Power (T-Power)

After you select T-Power, the system enters the zero span mode and calculates the power within the time domain. The available power types include Peak, Average, and RMS.

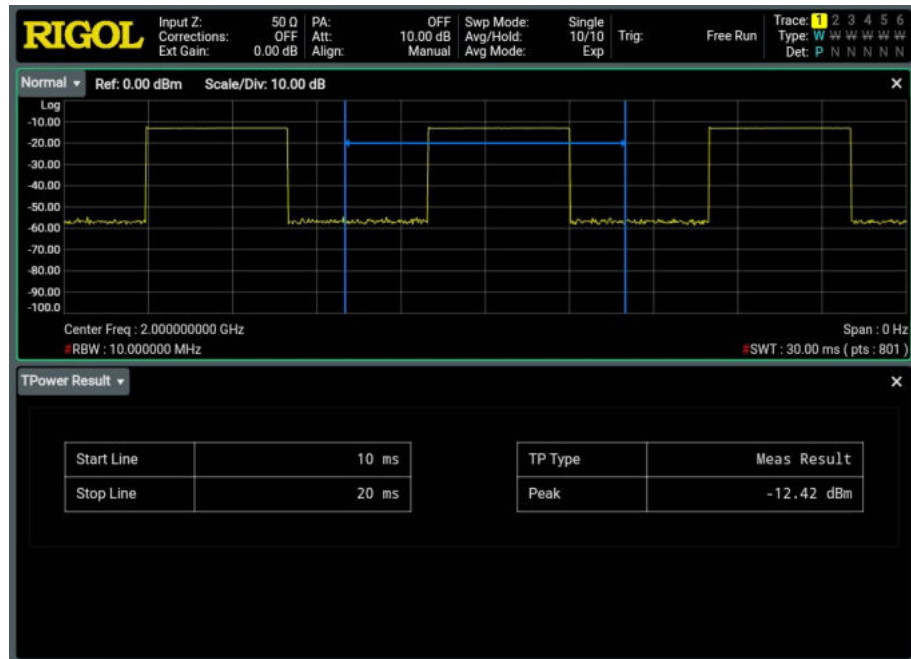

Figure 5.9 T-Power Measurement Interface

Test Result

T-power, i.e., the power of the signal from the start line to stop line.

Measurement Parameter

Measurement parameters: average count, average mode, average state, TP type, limit state, start line, and stop line.

1. Average Number

Specifies the number of times for averaging the measurement results. You can use the numeric keys, the knob, or arrow keys to modify this parameter; you can also use the touch screen to modify the parameter.

Parameter	Remarks
Default	10
Range	1 to 1,000
Unit	None
Knob Step	1
Left/Right Arrow Key Step	1

2. Average State

Sets whether to auto average the measurement results. By default, it is enabled.

3. Average Mode

Sets the average mode to "Exponential" or "Repeat". The default average mode is "Exponential".

- When "Exponential" is selected, the result is the exponential average of the measurement results obtained in the past N times (N is specified in "*Average Number*").
- When "Repeat" is selected, the result is the arithmetic average of the measurement results obtained in the past N times (N is specified in "*Average Number*").

4. TP Type

- Peak

Displays the power of the signal (with the maximum amplitude) between the start line and stop line. The detector type is set to "Pos Peak" automatically.

- Average

Displays the average power of signals between the start line and stop line. The detector type is set to "Voltage Avg" automatically.

- RMS

Displays the root mean square value (expressed in W) of the voltages of signals between the start line and stop line. The detector type is set to "RMS Avg" automatically.

5. Limit State

Enables or disables the limit state function. When the limit state function is enabled, the measurement range is delimited by the left and right limit lines; when the limit state function is disabled, the measurement range is the entire sweeping time.

6. Start Line

Sets the left boundary (in time unit) of T-Power measurement. The calculation range for the data of T-Power measurement is from the start line to the stop line. You can use the numeric keys, the knob, or arrow keys to modify this parameter; you can also use the touch screen to modify the parameter.

Parameter	Remarks
Default	0 μ s

Parameter	Remarks
Range	0 us to (current value of stop line)
Unit	s, ms, μ s, ns, ps
Knob Step	sweep time/600, Min = 1 μ s
Left/Right Arrow Key Step	at 1-1.5-2-3-5-7.5 step

7. Stop Line

Sets the right boundary (in time unit) of T-Power measurement. The calculation range for the data of T-Power measurement is from the start line to the stop line. You can use the numeric keys, the knob, or arrow keys to modify this parameter; you can also use the touch screen to modify the parameter.

Parameter	Remarks
Default	1 ms
Range	current value of start line to current value of sweep time
Unit	s, ms, μ s, ns, ps
Knob Step	sweep time/600, Min = 1 us
Left/Right Arrow Key Step	at 1-1.5-2-3-5-7.5 step

5.4 Marker Measurement

5.4.1 Marker Setting

Marker is a triangle sign (as shown in the following figure), which is used for marking the point on the trace. Through the marker, you can read the amplitude and frequency of the point on the trace, or the sweep time point.

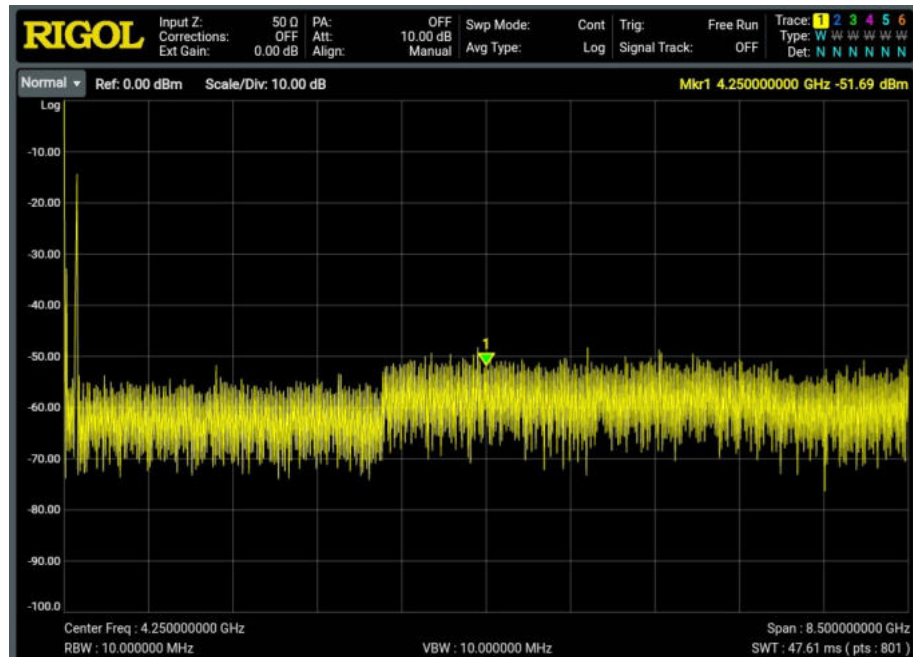

Figure 5.10 Marker

Key Points:

RSA6000 offers 8 markers, and only a single marker or one pair of markers can be turned on each time.

5.4.1.1 Selected Marker

RSA6000 provides 8 markers. By default, Marker1 is selected under "Selected Marker". After you select a marker, you can set parameters such as the marker mode, the marker trace, and marker readout. The currently enabled marker will be marked on the trace selected under **Marker Trace**. The readout of the currently activated marker at the marker point will be displayed in the measurement result bar at the upper-right corner of the screen.

5.4.1.2 Next Marker

Click or tap **Next Marker** to select the next enabled marker.

5.4.1.3 Marker Mode

Sets the type of the marker. The available marker modes include Position, Delta, Fixed, and OFF.

1. Position

It is used to measure the X (Frequency or Time) and Y (Amplitude) values of a certain point on the trace. When "Position" is selected, a marker indicated by a number (e.g., "1") appears on the trace.

Key Points:

- If no active marker exists currently, a marker will be enabled at the center frequency of the current trace.
- The readout resolution of the X-axis (frequency or time) is related to the span. To obtain a higher readout resolution, reduce the span.

2. Delta

It is used to measure the difference between "reference point" and "certain point on the trace": X (frequency or time) and Y (amplitude) value. When "Delta" is selected, a pair of markers appears on the trace: Reference Marker (marked by "X") and the Delta Marker (marked by "△").

Key Points:

- If an active marker exists currently, then activate a reference marker at the current marker; otherwise activate both the reference marker and Delta marker at the same time at the center frequency.
- When you change the position of the Delta marker, the position of the reference marker remains unchanged, but the frequency (or time) difference between the two markers will change along with it.
- The frequency (or time) difference between the two markers and the amplitude difference between them are displayed in the measurement result bar at the upper-right corner of the screen.

Application of the "Delta" Marker:

It is used to measure the S/N ratio of the single spectrum signal. Move the reference marker to the location where the signal resides, and move the Delta marker to the location where the noise resides. The amplitude displayed in the measurement results is S/N ratio.

3. Fixed

When you select "Fixed" marker, you can directly or indirectly set the X-axis and Y-axis values for the marker. Once specified, its position remains unchanged, and its Y-axis value does not change along with the trace. The fixed marker is generally used as the reference marker for the Delta marker. It is indicated by the sign "×".

4. OFF

Turns off the marker currently selected. Then, the marker information displayed on the screen and the functions concerning the marker will also be disabled.

5.4.1.4 Reference Marker

Sets the reference marker for the current marker. By default, the reference marker is the marker next to it.

Key Points:

- Each marker can have another marker to be its reference marker.
- If the current marker is a Delta marker, the measurement result of the marker will be determined by the reference marker.
- Any marker cannot take itself to be the reference marker.

5.4.1.5 Marker Trace

Selects the trace that the current marker marks. It can be Trace1, Trace2, Trace3, Trace4, Trace5, or Trace6. One marker can only mark one trace. The selected trace determines the position of the marker, the readout unit of the marker, and the final readout results.

5.4.1.6 Marker Trace Auto

Enables or disables the auto marking trace function.

Key Points:

- When you enable the marker's auto marking trace function, the marker shifts from its off state to on state, and the marker's marking trace is automatically determined by the instrument.
- When you disable the marker's auto marking trace function, whatever states of the marker and the trace, the marker will be associated to the current marker trace.
- If you specify the marker's marking trace manually, the marker's auto marking trace function is automatically disabled.

5.4.1.7 Marker Frequency/Time

Sets the frequency (non-zero span) or time (zero span) of the marker to change the position of the marker on the trace. Click or tap this menu to modify the value to change the position of the marker.

Parameter	Remarks
Default	Frequency (non-zero span): span/2 + start frequency Time (zero span): sweep time/2
Range	Marker Readout = Frequency (or 1/Time): 0 to F_{max} Marker Readout = Time (or Period): 0 s to 6,000 s.
Unit	Marker Readout = Frequency (or 1/Time), units available are GHz, MHz, kHz, Hz (or ks, s, ms, us, ns, ps) Marker Readout = Time (or Period), units available are s, ms, μ s, ns, ps
Knob Step	Marker Readout = Frequency (or 1/Time), step = span/(sweep points - 1) Readout = Time (or Period), step = Sweep Time/(Sweep Points - 1)
Left/Right Arrow Key Step	Marker Readout = Frequency (or 1/Time), step = span/10 Marker Readout = Time (or Period), step = sweep time/10

5.4.1.8 Marker Amplitude

When the marker type is set to "fixed", you can press this key to set the Y value of the current marker.

5.4.1.9 Marker Readout

Selects a desired readout type of the X-axis for the marker and each marker can be configured with different readout types. This setting will change the readout type and will not change the actual value. The setting will affect the marker readouts in the measurement result bar at the upper-left corner of the screen.

1. Frequency

If you select "Frequency" to be the readout type, the "Position" and the "Fixed" marker modes display the absolute frequency; whereas the "Delta" marker mode displays the frequency difference between the Delta marker and the reference marker. In non-zero span mode, the default readout is "Frequency".

2. Time

If you select "Time" to be the readout type, the "Position" and the "Fixed" marker modes display the time difference between the marker and the start of the sweep;

whereas the "Delta" marker mode displays the sweep time difference between the Delta marker and the reference marker.

In zero span mode, the default readout is "Time".

3. 1/Time

If you select "1/Time" to be the readout type, it displays the reciprocal of sweep time difference between the Delta marker and the reference marker. When the time difference is zero, the reciprocal is infinite, and "---" is displayed.

4. Period

If you select "Period" to be the readout type, the "Position" and the "Fixed" marker modes display the reciprocal of the marker frequency; whereas the "Delta" marker displays the reciprocal of the frequency difference. When the frequency difference is zero, the reciprocal is infinite, and "---" is displayed.

5.4.1.10 Readout Auto

Enables or disables the readout auto function.

Key Points:

- When you enable the function, if the trace is the frequency-domain trace, then the readout mode is frequency.
- If the marker is in auto reading state, and the marker trace changes, then the readout mode should be re-determined based on the destination trace.
- If the readout mode of X Scale is set to Manual, then the X-Scale value will not change with the trace.

5.4.1.11 Line State

Enables or disables the marker line.

Key Points:

- When you enable the marker line, a cross line is displayed at the amplitude point where the marker resides. The width of the horizontal line and the height of the vertical line are consistent with the length and height of the graticule in the waveform display area.
- If the marker is not visible in the selected area, extend the marker line to the display area for better observation. This function is useful for the marker

outside the display area. The marker extension line can better display the amplitude of the marker, making it easy for you to observe and compare.

5.4.1.12 Couple Markers

Enables or disables the marker coupling function.

Key Points:

- When this function is enabled, moving any marker will enable other markers (except the Fixed or Off marker) to move with it.
- The fixed marker does not move along with other marker, but if the fixed marker moves, other non-fixed markers will move with it.

5.4.1.13 Marker Table

Enables or disables the marker table.

Enable marker table. Then the marker table is displayed. The table lists the marker number, trace number, marker mode, X-axis readout, amplitude, and etc. Through this table, you can view the measurement values of multiple points.



Figure 5.11 Marker Table



NOTE

The marker table currently opened can be saved to the internal or external memory. Click or tap **Save** to save it according to descriptions in *Save*.

5.4.1.14 All Markers Off

Turns off all the enabled markers and their related functions.

5.4.2 Marker To

Sets the other system parameters (such as center frequency and reference level) by using the current marker values. Click or tap  > **Marker To**, then click or tap any of its sub-menu. Then a marker is automatically activated.

5.4.2.1 Mkr->CF

Sets the center frequency of the analyzer to the frequency of the current marker.

- If Position marker is selected, the center frequency will be set to the frequency of the current marker.
- If Delta marker is selected, the center frequency will be set to the frequency of the Delta marker.
- This function is invalid in zero span.

5.4.2.2 Mkr->CF Step

Sets the center frequency step of the analyzer to the frequency of the current marker.

- If Position marker is selected, the center frequency step will be set to the frequency of the current marker.
- If Delta marker is selected, the center frequency step will be set to the frequency difference between the Delta marker and the reference marker.
- This function is invalid in zero span.

5.4.2.3 Mkr->Start

Sets the start frequency of the analyzer to the frequency of the current marker.

- If Position marker is selected, the start frequency will be set to the frequency of the current marker.
- If Delta marker is selected, the start frequency will be set to the frequency of the Delta marker.
- This function is invalid in zero span.

5.4.2.4 Mkr->Stop

Sets the stop frequency of the analyzer to the frequency of the current marker.

- If Position marker is selected, the stop frequency will be set to the frequency of the current marker.
- If Delta marker is selected, the stop frequency will be set to the frequency of the Delta marker.
- This function is invalid in zero span.

5.4.2.5 Mkr->Ref

Sets the reference level of the analyzer to the amplitude of the current marker.

- If Position marker is selected, the reference level will be set to the amplitude of the current marker.
- Given a Delta marker, if the current marker is the reference marker, then the reference level is set to the amplitude of the reference marker; if the current marker is the Delta marker, then the reference level is set to the amplitude of the Delta marker.

5.4.2.6 Marker Δ ->CF

Sets the center frequency of the analyzer to the frequency difference between the two Delta markers.

- This function is only valid when the Delta marker is selected.
- This function is invalid in zero span.

5.4.2.7 Mkr Δ ->Span

Sets the span of the analyzer to the frequency difference between the two Delta markers.

- This function is only valid when the Delta marker is selected.
- This function is invalid in zero span.

5.4.3 Marker Function

5.4.3.1 N dB State

Enables or disables the N dB bandwidth measurement function.



NOTE

In the N dB measurement state, if the current marker is disabled, then the N dB BW measurement function is also disabled.

5.4.3.2 N dB Bandwidth

Sets the N dB value.

The N dB bandwidth denotes the frequency (time) difference between two points that are located on both sides of the current marker and with N dB fall ($N < 0$) or rise ($N > 0$) in amplitude, as shown in the figure below.

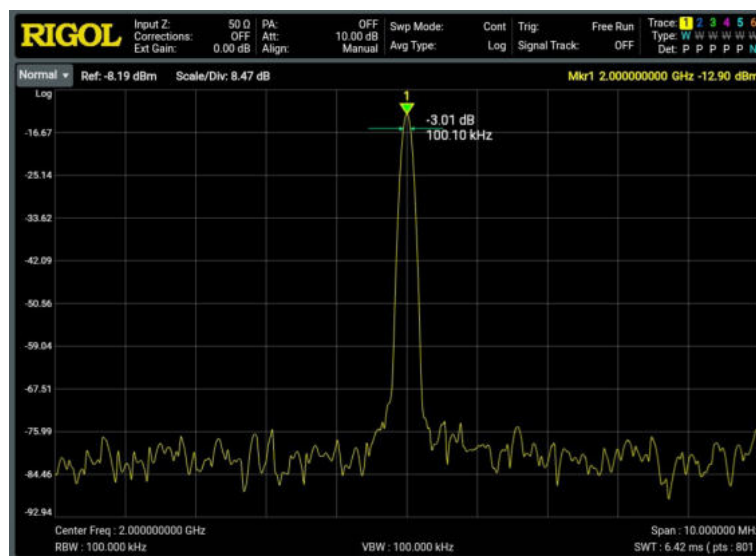

Figure 5.12 N dB Bandwidth Measurement

Key Points:

- When the measurement starts, the analyzer will search for the two points (time) which are located at both sides of the current point (time) with N dB fall or rise in amplitude. Once the two points are found, the analyzer will display the frequency (time) difference between the two points in the active function area. Once not found, "----" is displayed.
- You can use the numeric keys, the knob, or arrow keys to modify the value of N. For details, refer to descriptions in *Parameter Setting*.

Parameter	Remarks
Default	-3.01 dB
Range	-140 dB to -0.01 dB
Unit	dB
Knob Step	1 dB
Left/Right Arrow Key Step	1 dB

5.4.3.3 Band Function

The band function defines the corresponding parameters for a frequency band measurement signal at the marker point. When the band function is enabled and auto detector is enabled, the trace detector type is automatically modified to "RMS Average".

1. Noise

When the noise measurement function is enabled, the measurement result of the Y-axis is the average noise level normalized to 1 Hz within the frequency band.

2. Band Power

In non-zero span mode, it calculates the total power within a span. In zero span mode, it calculates the average power within a certain time range.

3. Band Density

In non-zero span mode, the band density is the calculation result of dividing the total power within the bandwidth to be measured by the measurement bandwidth. In zero span mode, the band density is the measured band power divided by Bn (Bn refers to the noise bandwidth of the RBW filter.)

4. OFF

Disables the band function. Disabling the band function will neither affect the frequency band parameters nor disable the marker.

5.4.3.4 Band Adjustment

Adjusts the band parameter for the band function.

1. Band Span

Sets the bandwidth of the signal involved in the calculation for the band function.

2. Band Left

Sets the left edge frequency of the signal involved in the calculation for the band function.

3. Band Right

Sets the right edge frequency of the signal involved in the calculation for the band function.

4. Band Span Auto

Enables or disables the auto setting of the band span. When it is enabled, the band span is automatically adjusted. The band span is 5% of the span or 5% of the sweep time. When it is disabled, you can set the band span parameter manually.

5.4.3.5 Marker Counter

Enables or disables the frequency counter function of the current marker.

Key Points:

- If no active marker currently exists, turning on the frequency counter will open a Position marker automatically.
- The frequency readout will be more accurate when the frequency counter is enabled.
- In zero span mode, enabling the frequency counter can measure the frequency near the center frequency.
- In the Delta marker mode, if the current reference marker is not Fixed type, the reference marker can also be used for frequency count.

5.4.3.6 Gate Time

Sets the length of time for the marker counter to make measurements.

Parameter	Remarks
Default	100 ms
Range	1 μ s to 500 ms
Unit	s, ms, us, ns, ps
Knob Step	gate time/100, Min = 1 us
Left/Right Arrow Key Step	at 1-1.5-2-3-5-7.5 step

5.4.3.7 Gate Time Auto

Enables or disables the auto gate time of the marker counter.

Key Points:

- When Gate Time Auto is enabled, and the gate time of the marker count is determined by the instrument automatically.
- When Gate Time Auto is disabled, set Gate Time manually.

5.4.4 Peak Search

The peak search function enables the marker to move to the specific signal peak point, and then in combination with the function of Delta marker, it can provide a powerful analysis capability.

5.4.4.1 Peak Search

Performs the peak search function.

Key Points:

- If Max is selected for Search Mode, the system will search for the maximum value on the trace and mark it with a marker.
- If Config is selected for Search Mode, the system will search for the peak of the specified parameter on the trace and mark the peak with a marker.
- The peak search for the Next Peak, Next Peak Right, Next Peak Left, or peaks in the peak table must meet the specified peak search condition.
- When no peak meets the specified peak search condition, "No peak found" is displayed.

5.4.4.2 Next Peak

Searches for and marks the peak whose amplitude on the trace is next to that of the current peak and which meets the peak search condition.

5.4.4.3 Next Peak Right

Searches for and marks the nearest peak which is located at the right side of the current peak and meets the peak search condition.

5.4.4.4 Next Peak Left

Searches for and mark the nearest peak which is located at the left side of the current peak and meets the peak search condition.

5.4.4.5 Minimum Search

Searches for and marks the peak with the minimum amplitude on the trace.

5.4.4.6 Pk-Pk Search

Executes Peak Search and Minimum Peak functions at the same time, and marks the results with the Delta marker. Wherein, the result of Peak Search is marked with the reference marker and the result of Minimum Peak is marked with the Delta marker.

5.4.4.7 Continuous Peak

Enables or disables continuous peak search. By default, it is OFF. When it is enabled, after finishing each sweep, the analyzer will automatically execute one peak search operation to track the measurement signal.



NOTE

- In Cont Peak, the system always searches for the maximum in the current frequency channel; while in Signal Track, the system will search for and mark the point (with no more than 3 dB variation in amplitude) near the marker before Signal Track is enabled, and then set the frequency of this point to be the center frequency.
- When the marker is a fixed type, the Cont Peak Min menu is grayed out and disabled.
- The signal track and Cont Peak Min functions are mutually exclusive. Once either of them is enabled, the menu of the other one will be disabled and grayed out.
- When the Cont Peak function is enabled, if the current marker is off, set the marker to Position mode, and then execute the Peak Search operation.

5.4.4.8 Cont Peak Min

Enables or disables continuous Min search. By default, it is OFF. When it is enabled, after finishing each sweep, the analyzer will automatically execute one Min search operation to track the measurement signal.



NOTE

- When the marker is a fixed type, the Cont Peak Min menu is grayed out and disabled.
- The signal track and Cont Peak Min functions are mutually exclusive. Once either of them is enabled, the menu of the other one will be disabled and grayed out.
- When the Cont Peak Min function is enabled, if the current marker is off, set the marker to Position mode, and then execute the Minimum Search operation.

5.4.4.9 Peak Table

Turns on or off the peak table. By default, it is Off.

When the peak table is turned on, the display is split into a measurement window and a peak table display window. The peak table will be displayed at the lower section of the screen, displaying the searched parameters (frequency and amplitude) that meet the criteria. You can use an external mouse to click and scroll up and down, use the touch-enabled gestures, the up and down arrow keys on the front

panel, and the corresponding external keyboard shortcuts to perform page up and down operations in the peak table.

The marker table currently opened can be saved to the internal or external memory of the analyzer, and you can recall it at any time if you need. For details about saving the file, refer to descriptions in *Save*.

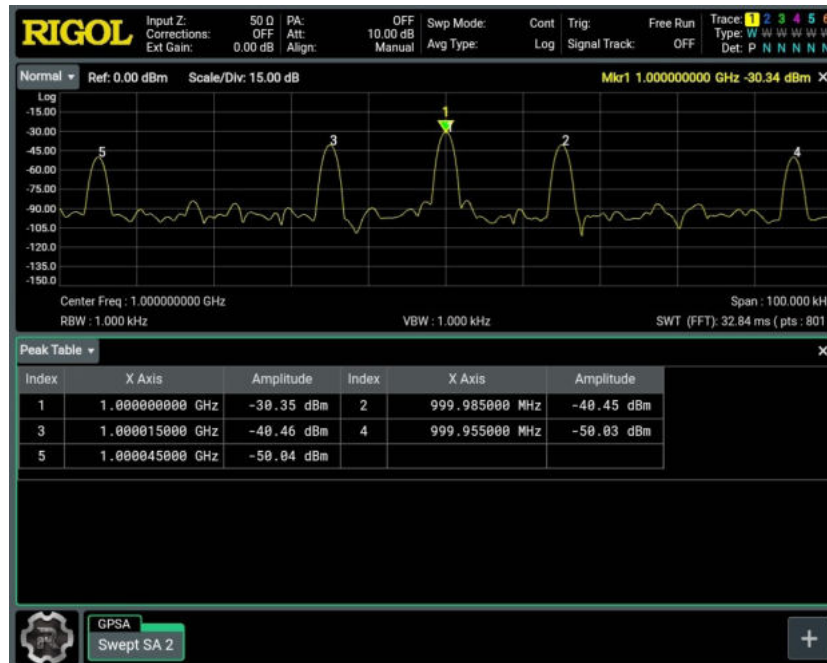

Figure 5.13 Peak Table

5.4.4.10 Peak Table Sort

Selects the peak table sorting rule. Two options are available: Freq and Ampt. That is, list the peak in the order of ascending frequency or descending amplitude.

5.4.4.11 Peak Table Readout

Sets the peak display condition to All, Above DL, or Below DL.

- **All**
Lists all the peaks defined by the peak criteria, displaying them according to the readout sequence in the peak table.
- **Above DL**
Displays the peaks meeting the peak criteria and whose amplitudes are greater than the specified display line in the table.
- **Below DL**
Displays the peaks meeting the peak criteria and whose amplitudes are smaller than the specified display line in the table.

**NOTE**

If the display line is off, the peak table displays all the peaks that meet the criteria. If you select "Above DL" or "Below DL" under "Pk Table Readout", you should turn on the display line first.

5.4.4.12 Display Line

Sets the display line level to change its display location. This line can be used as either the reference for you to read the measurement result or the threshold condition for the peaks displayed in the peak table. For details, refer to descriptions in *Display Line*.

**NOTE**

The peak table readout only has the coupling relationship with Display Line 1.

5.4.5 Peak Config

1. Peak Threshold

Sets the minimum value of the peak amplitude. Only when the peak is greater than the peak threshold, can it be judged as a peak.

Parameter	Remarks
Default	-90 dBm
Range	-200 dBm to 0 dBm
Unit	dBm, -dBm, V, mV, uV
Knob Step	1 dB
Left/Right Arrow Key Step	5 dB

2. Threshold State

Enables or disables the peak threshold function.

3. Peak Excursion

Sets the excursion of the peak amplitude. It defines the minimum amplitude variation required for a signal to be identified as peak.

Parameter	Remarks
Default	6 dB
Range	0 dB to 100 dB

Parameter	Remarks
Unit	dB
Knob Step	1 dB
Left/Right Arrow Key Step	5 dB

4. Excursion State

Enables or disables the peak excursion function.

Key Points:

- When the peak excursion function is enabled, you can set the Peak Excursion value.
- When the peak excursion function is disabled, the Peak Excursion menu is disabled and grayed out.

5. Threshold Line

Sets whether to display the peak threshold line or not. By default, it is OFF.

Key Points:

- When the threshold state is on, the threshold line is, by default, on; when the threshold state is off, the threshold line is off. The threshold line displays the amplitude it represents.
- If the excursion state is on, then the peak amplitude line will be displayed at the top of the peak threshold, and the peak area will be displayed at the left section.

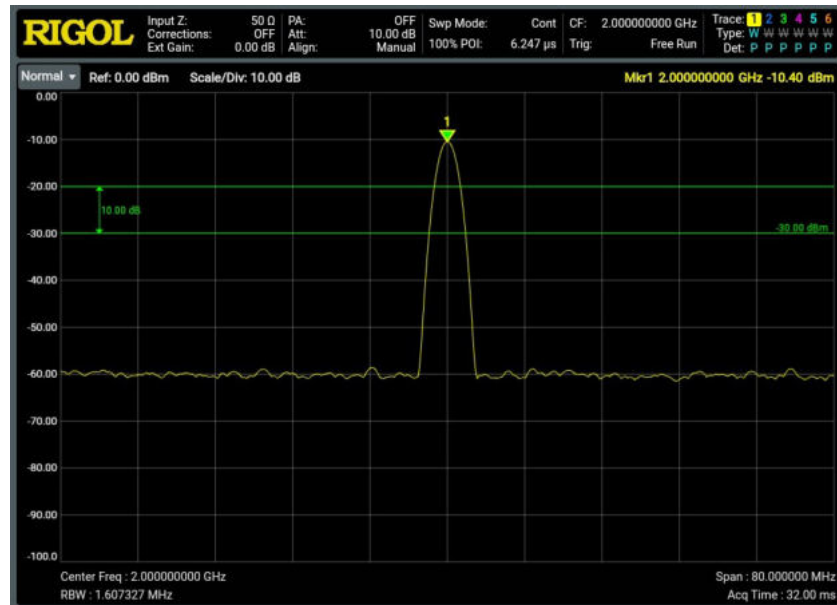

6. Search Mode

Sets the peak search condition: maximum value on the trace or the peak that meets the search criteria.

- The available options are Max and Config. If "Max" is selected, the system searches for the maximum value on the trace. This setting applies only to the peak search after you have click or tap **Peak Search**. Other searches such as Next Peak, Next Peak Right, and Next Peak Left are all searched based on "Config".
- If "Config" is selected, the system searches for the peak that meets the search criteria on the trace.

6 Functions of the Front Panel of RTSA

The real-time spectrum analyzer (RSA) contains the digital IF component that has a strong processing capability. In real-time mode, all signal samples are processed to produce measurement results or initiate a trigger. In most cases, like the frequency sweep analysis, the real-time analysis produces scalar results, such as power or amplitude.

The real-time spectrum analyzer has the following features:

- Seamless capture and analysis;
- High-speed measurement;
- Stable and consistent measurement speed;
- Frequency mask trigger (FMT);
- Diversified and advanced composite display

In general, the high-speed data stream in real-time mode can be used in the following two ways: to be served as the data source of composite spectrum display or be compared with the frequency mask to produce the frequency mask triggering.

This chapter describes in detail the function keys on the front panel of RSA6000 and their associated menu functions in RTSA mode.

NOTE

The keys or menus that have the same functions as those in GPSA mode will not be described in this chapter. For details, refer to descriptions in *Functions of the Front Panel of GPSA*.

6.1 Basic Settings

6.1.1 Freq

Press  on the front panel to enter the frequency setting menu. You can modify the frequency and span-related parameters in this menu.

For details about each sub-menu of Frequency menu, refer to *Freq*.

NOTE

"Signal Track" and "X Scale Type" menus are not available in RTSA mode.

6.1.1.1 Span

Sets the frequency range of the current channel.

Key Points:

- When you modify the span, the start and stop frequency will be modified automatically if the center frequency remains to be unchanged.
- When you set the span manually, the minimum span can be set to 5 kHz. When you select Full Span, the analyzer's real-time bandwidth is its maximum bandwidth currently supported.
- You can use the numeric keys, the knob, and the arrow keys on the front panel to modify this parameter; also you can modify it on the touchscreen. For details, refer to descriptions in *Parameter Setting*.

Parameter	Remarks
Default ^[1]	80 MHz
Range ^[2]	5 kHz to 80 MHz
Unit	GHz, MHz, kHz, Hz
Knob Step	span/200, Min = 2 Hz
Left/Right Arrow Key Step	at 1-2-5 step



NOTE

[1]: If the option RSA6000-RB200 is installed, its default value is 200 MHz.

[2]: If the option RSA6000-RB200 is installed, its range is from 5 kHz to 200 MHz.

6.1.1.2 Last Span

Sets the span to the previous span setting.

6.1.1.3 Full Span

Sets the maximum span.

Key Points:

- In RTSA mode, the maximum bandwidth for single data acquisition is the maximum IF bandwidth of the installed option.
- For standard configuration, the full span is 80 MHz.
- For the option RSA6000-RB200, the maximum bandwidth for single data acquisition is 200 MHz, so its full span is 200 MHz.

6.1.1.4 Ref Time (PvT)

Sets the reference time of the X-axis in the PvT display view. Modifying this value will not cause the instrument to remeasure. It is only used for trace display. Note that this menu is only valid when the instrument enters the PvT measurement mode. Note that this menu is only valid when the system enters the PvT measurement mode.

Parameter	Remarks
Default	0 s
Range	-1 s to 40 s
Unit	s, ms, μ s, ns, ps
Knob Step	reference time/100, Min = 1 μ s
Left/Right Arrow Key Step	at 1-1.5-2-3-5-7.5 step



TIP

The PvT measurement displays the power variation of the signal within the user-defined time range. The X-axis represents time and the Y-axis represents amplitude.

6.1.1.5 X-Scale (PvT)

Sets the scale of each division in the horizontal axis of the PvT view. Modifying this value will not cause the instrument to remeasure. It is only used for trace display. When you set Auto Scale to "Auto", this value will be modified automatically. Note that this menu is only valid when the system enters the PvT measurement mode.

Parameter	Remarks
Default	Acquisition Time/10
Range	20 μ s to 4 s
Unit	s, ms, μ s, ns, ps
Knob Step	X-Scale/100, Min = 1 μ s
Left/Right Arrow Key Step	at 1-1.5-2-3-5-7.5 step

6.1.1.6 Ref Position (PvT)

Sets the position of the reference time in the X-axis of the PvT window to "Left", "Middle", or "Right". Note that this menu is only valid when the system enters the PvT measurement mode.

6.1.1.7 Auto Scale (PvT)

Sets the setting mode of the X scale in the PvT view. Note that this menu is only valid when the system enters the PvT measurement mode.

Key Points:

- When you select "Auto", the system auto sets the X-Scale and reference value based on the acquisition time and reference position.
 - X-scale value is 10% of the acquisition time.
 - The reference value is different based on the selection of the reference position. If the reference position is set to "Left", the reference value is 0 s; if the reference position is set to "Middle", the reference value is half of the acquisition time; if the reference position is set to "Right", the reference value equals to the acquisition time.
- When you set the reference value and X-Scale manually, the Auto Scale menu is automatically switches to "Manual".

6.1.2 Display

Display View

In RTSA mode, the display views include Normal, Spectrogram, Density, Density Spectrogram, PvT, PvT Spectrum, and PvT Spectrogram.

After you select a measurement function, the screen is split into several display windows; in multi-window mode, you can touch the screen or use the mouse to select a specified window as the current window. If you select a different window, its corresponding menu will be different.

6.1.2.1 Normal

Measurement Interface

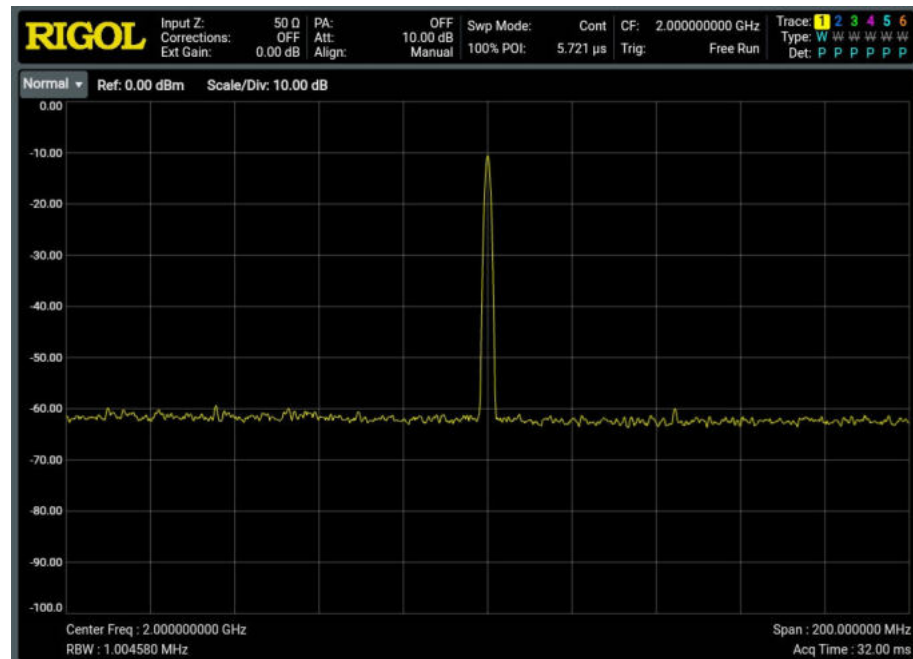

Figure 6.1 Normal View

After selecting the Normal measurement, the measurement interface is shown above. Click or tap **Display** to set the corresponding parameters.

Key Points:

- In RTSA mode, all signal samples are processed to produce measurement results based on the set mode or initiate a trigger.
- The parameter settings in Normal view include settings for "Display Line" and "Frequency Line". For detailed setting methods, refer to *Display Setting*.

6.1.2.2 Spectrogram

Measurement Interface



Figure 6.2 Spectrogram View

After selecting the Spectrogram measurement, the measurement interface is shown above. Click/tap **Display** to set the relevant parameters.

Key Points:

- The Spectrogram view is displayed in multiple windows, including displaying Normal window, and Waterfall window. In this view, the multiple windows have a coupling relationship. The conventional Normal view displays the specified spectrum line set by the trace parameters. When you select the Normal view, Limit measurement function is supported. In the Spectrogram view, a white horizontal line represents the currently displayed trace. In the Spectrogram mode, if the displayed trace value is 1, it indicates that it is a latest trace.
- In the view, each horizontal line represents a trace, and the vertical Y-axis represents time. The latest trace data is displayed at the top of the Spectrogram by default, and the historical traces are moved up one position. The Spectrogram can hold 8,192 traces. When Spectrogram occupies a Window that has full vertical size, 480 traces can be displayed at one time. When

Spectrogram occupies the vertical window in the lower section, 480 traces can be displayed at one time.

- In the Spectrogram view, the color bar is used to indicate the signal amplitude. The color bar is displayed at the left-most of the Waterfall window. For the settings of the color bar, refer to descriptions in *Reference Hue*.
- When you select a trace that has not yet been acquired, both the trace window and Spectrogram window will remain blank until the trace is acquired. Then, once a trace is acquired in the Spectrogram window, the window will be updated for one time. The trace window will show the specified trace.
- Any parameter change will clear out the spectrogram and restart an acquisition, unless in the idle state (single measurement or waiting for a trigger). The spectrogram data will also be cleared on exit from the Spectrogram view.
- In the Spectrogram view, zero time is the point where the first trace starts an acquisition, meaning that each subsequent trace point is at a positive time that represents when that point was gathered, relative to the start point. Each trace is time stamped as it starts, and this time is remembered for each trace. With the increase of the traces, the time difference for the successive traces get larger.

Spectrogram Setting

1. Display Trace

Sets the trace index displayed in the trace window in the Spectrogram view.

You can determine the trace either by the trace number or the trace time. Trace 1 indicates the newest trace. If you select the trace by trace time, select a trace that is closest to set time.

Parameter	Remarks
Default	1
Range	1 to 8,192
Unit	None

Parameter	Remarks
Knob Step	1
Left/Right Arrow Key Step	1

2. Display Mode

Sets the type for the trace to be displayed in the trace window to "Time" or "Number".

Each trace is associated with a time value that represents the acquisition time. The formula is as follows: Trace Time = Trace Number x Acquisition Time.

3. Trace Couple

Sets whether to couple the marker to the selected trace. Open a marker, and set Marker Z to n. The range of "n" is from 1 to 8,192. Set the trace number to n. At this time, enable the Trace Couple function. Then the marker will stay at Trace n and varies with it. When Trace Couple is disabled, the marker will be fixed to Marker Z when the marker was turned on. Modify the trace number, and the marker will not vary with the trace.

4. Reference Hue

Adjusts the hue at the top of the color bar in the Waterfall window. The color bar in the Waterfall window is placed next to the waveform display to map the amplitude and color.

Parameter	Remarks
Default	0
Range	0 to 359.9
Unit	None
Knob Step	0.01
Left/Right Arrow Key Step	at 1-1.5-2-3-5-7.5 step

5. Reference Hue Position

Sets the position of the reference hue in the graticule. Any amplitudes higher than the reference position are displayed as black.

Parameter	Remarks
Default	100
Range	Max (10%, bottom hue value + 10%) to 100.0
Unit	None
Knob Step	1

Parameter	Remarks
Left/Right Arrow Key Step	at 1-1.5-2-3-5-7.5 step

6. Bottom Hue Position

Sets the position of the the bottom hue in the graticule. Below the color bar is black, and any amplitudes in this region map as black.

Parameter	Remarks
Default	0
Range	0 to Min (90%, reference position value - 10%)
Unit	None
Knob Step	1
Left/Right Arrow Key Step	

7. Hue Auto

Auto adjusts the reference hue position and bottom hue position based on the highest amplitude value and lowest amplitude value found in the Spectrogram view. The reference hue position is set to the highest amplitude value, and the bottom hue position is set to the lowest amplitude value.

6.1.2.3 Density

Measurement Interface

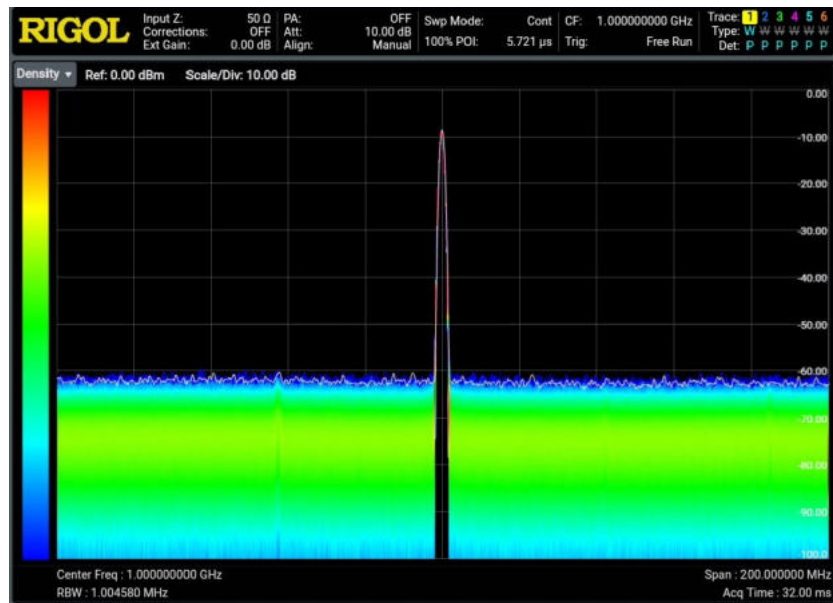

Figure 6.3 Density Display View

The measurement type is Density measurement. Its measurement interface is shown above. After selecting this measurement, click or tap **Display** to set the relevant parameters.

Key Points:

- The density is defined as the number of times a frequency and amplitude point is hit during an acquisition interval.
- A white trace will also be displayed in the Density display view. This trace shows the real-time spectrum for the latest acquisition interval. When using positive peak, negative peak, or average detectors, the white trace obtains detector data from all the data within the acquisition time; when using the Sample detector, the last FFT was used.
- To display the signal status within a longer time range, you can display multiple Density views on the screen. The latest Density view is displayed with the highest density hue, and the former Density view is represented with lower density hue. The color bar displaying the results is generally called persistence view.
- The Density view is displayed combined with the persistence view. X-axis represents frequency, Y-axis represents amplitude, Z-axis represents number of hits, and T-axis represents time. This view displays four dimensional data on a two dimensional display, using color to represent Z-axis and brightness to represent T-axis.

Density Setting**1. Duration Time**

Sets how long the frequency/amplitude points displayed in the bitmap should take to fade.

Key Points:

- The persistence controls the length of time it will take for a point to go from 100% intensity to 0% intensity.
- If the point in the bitmap does not appear again during the persistence time, then the point will gradually become transparent until it disappears.

2. Infinite Mode

Enables or disables the infinite mode of Duration display.

Key Points:

- When off, it indicates the finite mode. At this time, you can define the persistence time. You can observe the density of each point over the entire measurement time.
- When on, it indicates the infinite mode. Infinite mode shows the total number of times a frequency/amplitude point appear during all the capture intervals since starting the measurement. In the infinite mode, the intensity for all the frequency/amplitude points is 100%, and there will be no fading, but its density will will change with the measurement.

3. Palette

Selects different color palettes which allows optimization of visibility and contrast for different signal environment. In RTSA mode, there are five color palettes available for you to choose: Cool, Warm, Radar, Fire, and Frost. By default, "Warm" is selected to be the color palette.

4. Highest Density Hue

Sets the highest probability percentage of the density range.

Parameter	Remarks
Default	100
Range	0.1 to 100
Unit	None
Knob Step	0.1
Left/Right Arrow Key Step	at 1-1.5-2-3-5-7.5 step

5. Lowest Density Hue

Sets the lowest probability percentage of the density range.

Parameter	Remarks
Default	0
Range	0 to 99.9
Unit	None
Knob Step	0.1
Left/Right Arrow Key Step	at 1-1.5-2-3-5-7.5 step

6. Curve Nonlinearity

Within the range between the highest density hue and lowest density hue, setting the curve nonlinearity can change the gradient among different density hues, making the displayed results move towards either the higher or lower end of the gradient. Larger values for curve nonlinearity will compress the colors used towards the higher end of the color bar, and smaller values will compress the colors towards the bottom.

Parameter	Remarks
Default	75
Range	-100 to 100
Unit	None
Knob Step	1
Left/Right Arrow Key Step	at 1-1.5-2-3-5-7.5 step

7. Density Auto

Sets the highest density due to the highest density value found in the current bitmap; sets the lowest density hue to the lowest non-zero density value found in the current bitmap.

8. Truncation

Enables or disables the Truncation function. When on, the area that is greater than the maximum value and smaller than the minimum value will be indicated in black; when off, it is indicated by boundary value.

Parameter Setting

The parameter settings in Density view include settings for "Display Line" and "Frequency Line". For detailed setting methods, refer to [Display Setting](#).

6.1.2.4 Density/Spectrogram

Measurement Interface



Figure 6.4 Density/Waterfall Plot View

After selecting the Density/Spectrogram measurement, the measurement interface is shown above. Click or tap **Display** to set the relevant parameters.

Remarks:

- Density/Spectrogram combination view is in multi-pane windowing display, including Density and Waterfall plot views. In this view, multiple windows have a coupling relationship.
- The combined Density and Waterfall view display the traces, the occurrences of all the signals within the acquisition interval time, as well as the frequency/ amplitude and time information.

6.1.2.5 PvT

Measurement Interface

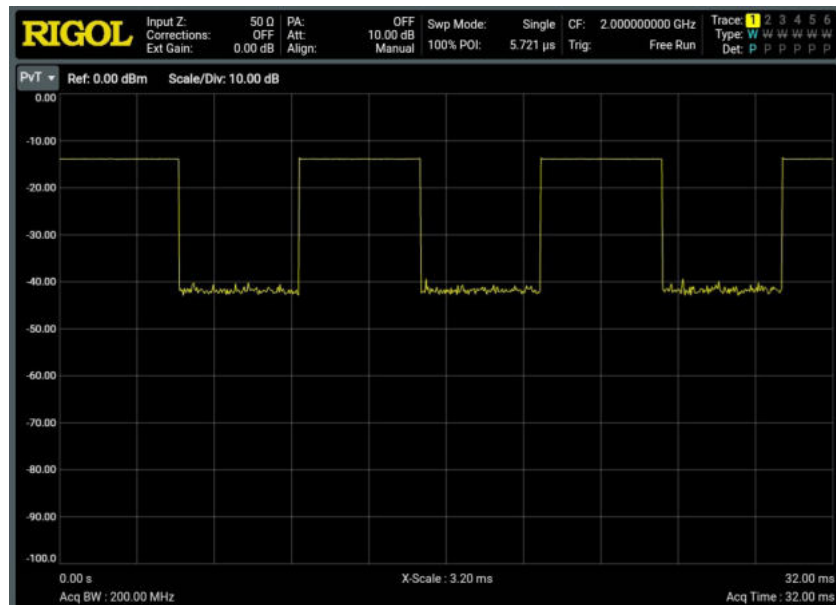

Figure 6.5 PvT View

After selecting the PvT measurement, the measurement interface is shown above. Click or tap **Display** to set the relevant parameters.

Key Points:

The PvT measurement provides an analysis for time-domain data. X-axis represents the acquisition time, and Y-axis represents the power value of the signal.

Parameter Setting

The parameter settings in PvT view include settings for "Display Line" and "Time Line". For detailed setting methods, refer to *Display Setting*.

6.1.2.6 PvT/Normal

Measurement Interface



Figure 6.6 PvT/Normal View

After selecting the PvT/Normal measurement, the measurement interface is shown above. Click or tap **Display** to set the relevant parameters.

Key Points:

- The PvT/Normal view is in multi-pane windowing, including PvT view and real-time Normal view. In PvT/Normal combination view, multiple windows have a coupling relationship.
- The parameter setting in the PvT/Normal view is consistent with that in the single PvT view.
- The parameter setting in the real-time normal spectrum combination view is consistent with that in the single normal view.

6.1.2.7 PvT/Normal/Spectrogram

Measurement Interface

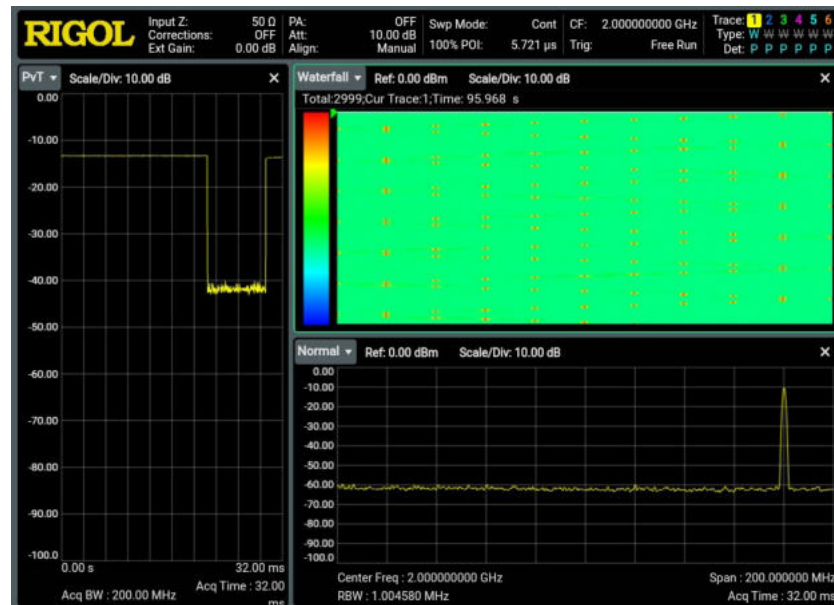

Figure 6.7 PvT/Normal/Waterfall Plot View

After selecting the PvT/Normal/Spectrogram measurement, the measurement interface is shown above. Click or tap **Display** to set the relevant parameters.

Key Points:

- The "PvT Spectrogram" view is in multi-pane windowing, including PvT view, real-time Normal view, and Waterfall window. In the "PvT Spectrogram" combination view, multiple windows have a coupling relationship. You can use the mouse or touch the screen to display one of the windows in full screen.
- The parameter setting in the real-time PvT Spectrogram combination view is consistent with that in the single specified measurement type view.

6.1.3 Ampt

Press **Ampt** on the front panel to enter the Amplitude setting menu. For details about each sub-menu of Amplitude menu, refer to *Ampt*. In this menu, Ref Level is, by default, selected.

NOTE

- The settings for the reference level and Y-axis scale values in the Normal view, Density view, and Waterfall Plot view are linked. Once these two parameters in any view are



modified, the settings for the two parameters in other two views will be updated with them simultaneously.

- The setting for the reference level and Y-axis scale values in the PvT view is independent of other views. Therefore, The parameter modification for reference level and Y-axis scale values in the PvT view will not affect the values in other views.

6.2 Sweep and Function Settings

6.2.1 BW

Press **BW** to enter the bandwidth setting menu. In this menu, you can select the filter type and RBW.

6.2.1.1 Resolution Bandwidth (RBW)

In RTSA mode, RBW selects from a pre-calculated selection of RBW values, which are computed based on the following formula: $RBW = SPAN/Ratio$. Wherein, Ratio is the Span/RBW ratio determined by the selected filter type.

In RTSA mode, there are 6 filter types available for you to choose. They correspond to 6 RBW values, namely RBW1 through RBW6. You can select a proper RBW value according to your needs.

Filter Type	Ratio1 1,024 pts	Ratio2 521 pts	Ratio3 256 pts	Ratio4 128 pts	Ratio5 64 pts	Ratio6 32 pts
Gaussian	404.761	205.938	101.190	50.595	25.298	12.649
Flattop	212.187	107.958	53.047	26.523	13.262	6.631
Blackman-Harris	399.131	203.074	99.783	49.891	24.946	12.473
Rectangular	800.782	-	-	-	-	-
Hanning	534.376	271.885	133.594	66.797	33.399	16.699
Kaiser	398.176	201.588	99.544	49.772	24.886	12.443



NOTE

When the filter type is set to "Rectangular", RBW is automatically set to "RBW1", and "RBW2 through RBW6" are invalid.

6.2.1.2 RBW Mode

Sets the coupling mode of RBW to be "Auto" or "Manual".

- When "Auto" is selected, except the Rectangular filter, other filter types select RBW2 by default.
- When you select "Manual" or directly set the RBW value, the coupling mode can be changed.

6.2.1.3 Filter Type

Sets the type of the FFT window function.

In RTSA mode, 6 filter types are available to choose: Gaussian, Flattop, Blackman-Harris, Rectangular, Hanning, and Kaiser.

You can select a proper filter type by referring to the following table according to the actual measurement requirements.

Window Function	Spectral Leakage	Amplitude Accuracy	Frequency Resolution
Gaussian	Moderate	Good	Medium
Flattop	Good	Excellent	Poor
Blackman-Harris	Excellent	Good	Medium
Rectangular	Poor	Poor	Excellent
Hanning	Good	Medium	Good
Kaiser	Good	Good	Medium



NOTE

When you select the PvT measurement display view, the BandWidth menu is disabled and grayed out.

6.2.2 Sweep

Press **Sweep** to enter the sweep setting menu. In this menu, set the sweep and control function of the analyzer.

6.2.2.1 Capture Time

Sets the acquisition time for producing one single trace or one persistence bitmap. In this mode, the generated single trace will combine multiple overlapped FFT analysis results.

Parameter	Remarks
Default	32 ms
Range ^[1]	100 us to 40 s
Unit	s, ms, μ s, ns, ps
Knob Step	capture time/100, Min = 1 μ s
Left/Right Arrow Key Step	at 1-1.5-2-3-5-7.5 step



NOTE

[1]: If a persistence bitmap exists, the minimum acquisition time can be set to 32 ms; if no persistence bitmap exists, the minimum acquisition time can be set to 100 μ s.

6.2.2.2 Acq Mode

Sets the mode of the acquisition time for the spectrum analysis to "Auto" or "Manual".

Key Points:

- When "Auto" is selected, the acquisition time adopts the default value.
- When "Manual" is selected, the acquisition time can be set manually within its available range.

6.2.2.3 Acq Time PvT

In PvT mode, the capture time applies to all the traces, including the spectrum traces and spectrogram traces. Note that this menu has the same function as the "Acq Time" menu under Sweep, but they are displayed differently in different measurement modes.

Parameter	Remarks
Default	30.00 ms
Range	100 us to 40 s
Unit	s, ms, μ s, ns, ps

Parameter	Remarks
Knob Step	capture time/100, Min = 1 μ s
Left/Right Arrow Key Step	at 1-1.5-2-3-5-7.5 step

6.2.2.4 Acq Time PvT Auto

Sets the acquisition time for the PvT analysis to "Auto" or "Manual".

Key Points:

- When "Auto" is selected, the acquisition time (PvT) adopts the default value.
- When "Manual" is selected, the acquisition time (PvT) can be set manually within its available range.

6.2.2.5 Sweep Mode

The sweep mode in RTSA mode and GPSA mode is the same in logical design. For detailed descriptions about the sweep mode, refer to *Sweep Mode*. This setting is global to all the activated traces.

6.2.2.6 Restart

Click or tap **Restart**, the current sweep will be suspended. All the previously measured data will be remeasured, and the trigger restores to the not-triggered state.

6.2.3 Trigger

Press **Trigger** on the front panel to enter the trigger setting menu. The settings for the trigger parameters are basically the same as that in GPSA mode. In RTSA mode, IF power trigger and FMT are added. The Video trigger are not supported.

The following section introduces the IF power trigger and FMT in detail. For the detailed information about trigger parameters such as trigger slope, trigger delay state, trigger delay, trigger delay time, trigger holdoff state, trigger holdoff, auto trigger state, and auto trigger, refer to *Trigger*.

6.2.3.1 Acquisition Times

Sets the number of times for acquisition after each trigger signal that meets the requirements generates a trigger in non-free trigger.

Parameter	Remarks
Default	1

Parameter	Remarks
Range	1 to 8,192
Knob Step	1
Left/Right Arrow Key Step	1



NOTE

When performing the single measurement, the instrument stops sweeping after the sweep count has reached N. Wherein, N is determined by the value obtained by multiplying the number of averaging times by the acquisition times in the current measurement mode.

6.2.3.2 IF Power

A trigger signal will be generated when the system detects a IF signal whose power level exceeds the specified trigger level.

Trigger Level

Sets the trigger level of the IF power trigger. When the signal meets the set trigger level value, a trigger occurs.

Parameter	Remarks
Default	-25 dBm
Range	(-140+Level Offset) to (30+Level Offset)
Unit	dBm, -dBm, V, mV, uV
Knob Step	1 dBm
Left/Right Arrow Key Step	5

6.2.3.3 FMT

1. Trigger Condition

Sets the condition that will cause the FMT trigger to occur. Both upper and lower masks use the same trigger criteria, and the trigger will occur when either mask meets the trigger criteria.

- Enter: Two states are required to initiate a trigger event. The signal must be outside the mask and then passes into the mask. The trigger event occurs when the first non-violating waveform is detected.
- Leave: Two states are required to initiate a trigger event. The signal must be inside the mask and then passes out of the mask. The trigger event occurs when the first non-violating waveform is detected.

- Inside: Only one state is required to initiate a trigger event. The signal has at least one data point inside (above) the mask. The trigger event occurs when the instrument detects the first signal with a point violating the mask.
- Outside: Only one state change is required to initiate a trigger event. The signal has all data points outside (below) the mask. The trigger event occurs when the instrument has detected the first spectral waveform that is completely outside (below) the mask.
- Enter-Leave: Three states are required to initiate a trigger event. The signal starts outside the mask and then passes into the mask. Next, the signal must pass outside the mask. The trigger event occurs at the second transition where the signal passes back out of the mask.
- Leave-Enter: Three states are required to initiate a trigger event. The signal starts inside the mask and then passes out of the mask. Next, the signal must pass into the mask. The trigger event occurs at the second transition where the signal passes back into the mask.

2. Mask Type

Sets the currently effective trigger mask type.

- Upper: only sets the upper trigger mask to be effective.
- Lower: only sets the lower trigger mask to be effective.
- Both: sets both the upper and lower trigger masks to be effective.

NOTE

When "Upper Mask" is selected under "Mask Type", the trigger mask is, by default, the upper mask; when "Lower" is selected under "Mask Type", the trigger mask is, by default, the lower mask; when "All Mask" is selected under "Mask Type", the trigger mask is, by default, the one before switching the mask type.

3. Edit

Click or tap this menu to enter the FMT editing interface. You can use the front panel keys to set the FMT. Besides, you can also click or tap the input field of the specified parameter to set and edit the FMT parameters in the FMT editing interface. In the interface, you can quickly set the common parameters. The setting methods are the same as what you do with the front panel keys.

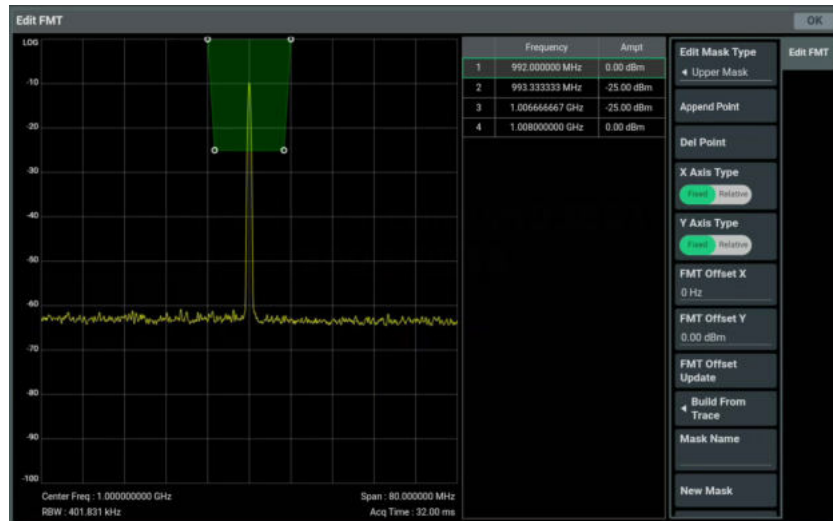

Figure 6.8 FMT Editing Interface

a. Edit Mask Type

Selects the mask type that needs to be activated currently. The following operations for editing and setting the mask points are only valid for the currently activated mask type.

b. Append Point

Appends a mask point.

c. Delete Point

Deletes the currently selected mask point.

d. X Axis Type

When "Fixed" is selected, the frequency of the current mask point will not be affected by the center frequency. When "Relative" is selected, the frequency of the current mask point is the difference between the frequency of the current mask point and the current center frequency. If you change the parameter state after completing the mask setup, the frequency of the mask should change with the state to keep the mask points to be in the same position relative to the current center frequency of the instrument.

e. Y Axis Type

When "Fixed" is selected, the amplitude of the current mask point will not be affected by the reference level. When "Relative" is selected, the amplitude of the current mask point is the difference between the amplitude of the current mask point and the current reference level. If you change the parameter state after completing the mask setup, the amplitude of the mask should change with the state to keep the mask points to be in the same position relative to the current reference level of the instrument.

f. FMT Offset X

Sets the offset of all the frequency points of the currently activated mask.

g. FMT Offset Y

Sets the offset of all the amplitude points of the currently activated mask.

h. FMT Offset Update

Adds the frequency and amplitude offsets to each point of the current mask.

i. Build From Trace

Selects a desired trace to build a mask.

j. Mask Name

Sets the name of mask file.

k. New Mask

Clears the currently activated mask and creates a default new mask.

l. Delete Mask

Deletes the currently activated mask.

4. Import FMT

Click or tap this menu, and then the file manager interface is displayed. You can import the mask from the file. You can also click or tap **Recall** > **FMT** to recall the mask from the file.

5. Export FMT

Exports the mask to the file. You can also click or tap **Save** > **FMT** to save the mask to the file.

6.2.4 Trace

Press  on the front panel to enter the Trace setting menu. In this menu, you can perform the operations related to trace, such as trace acquisition, trace display, trace saving, trace detector, and trace data.

Remarks:

- Normal view: all the traces are available. The trace type can be set to any of the available trace types.
- Density view: only Trace1 is available. The trace type can be set to any of the available trace types.
- Waterfall view: all the traces are available.
 - Trace1: The trace type can only be set to "Clear Write", and the rest trace types are disabled and grayed out.
 - Trace2 through Trace6: The trace type can be set to "Clear Write", "Max Hold", and "Min Hold". The trace type "Average" is disabled.

- Trace math operation function is disabled.
- PvT view: Only Trace 1 is available; trace type can only be set to "Clear Write"; trace math operation function is disabled.

6.2.4.1 Detector Type

Sets the detector type. It is global setting to all the traces. The trace detector is, by default, determined automatically by the instrument. If you set the type of the trace detector manually, the detector auto setting function will be disabled. The available trace detectors include Pos Peak, Neg Peak, Sample, and Voltage Average.

For details about the Trace menu in RTSA mode, refer to descriptions in [Trace](#).

6.3 Measurement Settings

6.3.1 Meas Setup

 In the Meas Setup menu, only the menu items related to the current measurement function are displayed. Please view the relevant menus according to the current measurement function.

6.3.1.1 Avg Number

Specifies the number of times for averaging the measurement results. The average value is displayed in a real-time manner for each measurement.

Parameter	Remarks
Default	100
Range	1 to 1,000
Unit	None
Knob Step	1
Left/Right Arrow Key Step	1

6.3.1.2 Limit

Sets the parameters of limit lines. For details, refer to "[Limit](#)". Only when you select Normal view, can you operate on the limit line.

6.3.1.3 Global CF Mode

1. Global CF Mode

Turns on or off the global center frequency. In any working mode, if you enable the global center frequency mode, then the global center frequency will be set to the center frequency of the current mode. When a different working mode is selected, the global center frequency will be set to the center frequency of the previous working mode, that is, the one that is before switching the working mode. If you change the center frequency in any working mode, then the global center frequency will change with it.

2. Global CF

Sets the global center frequency. It is only available when you enable the global CF mode.

6.4 Marker Setting

6.4.1 Marker

The marker function of the RTSA mode in the normal view is basically the same as that in the GPSA mode.

NOTE

If "Waterfall" view is selected, the "Marker Z" menu is enabled.



6.4.1.1 Marker Trace

Selects the trace that the current marker marks. It can be Trace1, Trace2, Trace3, Trace4, Trace5, Trace6, or PvT Trace1. One marker can only mark one trace. The selected trace determines the position of the marker, the readout unit of the marker, and the final readout results.

NOTE

When PvT Trace1 is selected as the marker trace, Marker Readout and Readout Auto menus are hidden.



6.4.1.2 Marker Z

Sets the marker number of the trace on which the marker resides in the Spectrogram view. This menu is only valid when the Waterfall window is opened and the marker trace is not PvT trace.

For details about marker information, refer to descriptions in *Marker Setting*.

6.4.2 Marker To

The "Marker To" function in RTSA mode is basically the same as that in the GPSA mode. When the Marker Trace selects "PvT Trace1", only "Marker To Ref" sub-menu is available under the "Marker To" menu.

For details about "Marker To" function, refer to descriptions in [Marker To](#).

6.4.3 Marker Function

In RTSA mode, in the real-time spectrum view, only N dB measurement and bandwidth are supported.

For details about the N dB bandwidth and band function, refer to descriptions in [Marker Function](#).

6.4.4 Peak

The peak function in RTSA mode and GPSA mode is the basically the same. For details about the peak function, refer to [Peak Search](#).

7 Input/Output

Sets the input/output interface.

7.1 Input Impedance

Sets the input impedance for voltage-to-power conversions. The default input impedance is 50 Ω . To measure a 75 Ω device, you should use a 75 Ω to 50 Ω adapter (option) supplied by RIGOL to connect the analyzer with the system under test, and then set the input impedance to 75 Ω .

7.2 Ext Gain

Compensates for gain or loss in the measurement system outside the instrument.

Remarks:

- This value can change the trace position, but will not change the Y-axis reference value and scale.
- You can use the numeric keys, the knob, and the arrow keys on the front panel to modify this parameter; also you can modify it on the touchscreen. For details, refer to descriptions in *Parameter Setting*.

Parameter	Remarks
Default	0 dB
Range	-120 dB to 120 dB
Unit	dB
Knob Step	1 dB
Left/Right Arrow Key Step	1 dB

7.3 Trig Out

Trig Out

Enables or disables the trigger output.

Trig Out Polarity

Click or tap to select "Positive" or "Negative" under **Trig Out Polarity**.

7.4 Amplitude Correction

The amplitude correction is an important tool for improving the measurement accuracy. It can compensate the amplitude errors caused by the device gain and loss during transmission to ensure the accuracy and consistency of the measurement results. The available amplitude corrections of the RSA6000 series spectrum analyzer include "Antenna", "Cable", "User", and "Other".

When the amplitude correction is enabled, you can enable the correction, apply all the corrections, delete all the amplitude corrections, edit the correction, import and export the correction files.

Select the Amplitude Correction Type

The available amplitude correction types include Antenna, Cable, Other, and User.

Correction Switch

Click or tap the ON/OFF tab for **Enable** to enable or disable the correction.

Edit

- Append Point: Appends one correction data point.
- Delete Point: Deletes one correction data point.
- Delete: Deletes all the added amplitude correction points.
- Freq Interpolation: Sets the frequency interpolation for the Amplitude Correction to "Lin" or "Log".
- Description: Adds the descriptions for the amplitude correction.
- Comment: Adds the comments for the amplitude correction.

Apply all the Amplitude Correction

Click or tap the ON/OFF tab for **Apply All** to enable or disable applying all the amplitude corrections. When enabling the "Apply All" function, all the currently enabled correction data will all apply to the trace. At this time, the data shown on the screen are those that have undergone amplitude correction.

Delete All Amplitude Correction

Click or tap **Delete All** to delete all the amplitude correction data and parameters. Then the amplitude correction is disabled automatically.

Import

Click or tap **Import**, and then file management interface is displayed. Select a file, and then click or tap **Import** to import the file.

Export

Click or tap **Export**, and then file management interface is displayed. Select a file, and then click or tap **Export** to export the file.

8 Shortcut Key

8.1 Auto

Automatically searches for the signal within the full frequency band, and adjusts the frequency and amplitude for optimal display effect of the signal to realize one-key signal search and auto setting of parameters.

Key Points:

- Some parameters such as the reference level, scale, input attenuation, and maximum mixer level may be changed during the auto search.
- The Auto function is disabled in the following conditions: when the advanced measurement function in GPSA mode is enabled; when the calibration signal is enabled; when in the RTSA mode.

8.2 Preset

Recalls the preset setting and restores the system settings of the analyzer to a specified status.

Press  on the front panel to restore the instrument to its factory default settings.

You can also click or tap  at the upper-right corner of the screen to recall the factory settings. The following table lists the factory default settings (except items specified in Note [3]) or user-defined settings.

Parameter Name	GPSA Parameter Value	RTSA Parameter Value (RSA6000-B200)	
		Non-PvT	PvT
Freq			
Center Frequency	13.25 GHz	13.25 GHz	
Start Freq	0 Hz	13.15 GHz	
Stop Freq	26.5 GHz	13.35 GHz	
CF Step	Auto, 2.65 GHz	Auto, 20 MHz	
Freq Offset	0 Hz	0 Hz	
Signal Track	Off	-	

Parameter Name	GPSA Parameter Value	RTSA Parameter Value (RSA6000-B200)	
		Non-PvT	PvT
Span	26.5 GHz	200 MHz	
Ref Value	-	-	0 s
X Scale	-	-	3.2 ms
Ref Position	-	-	Left
Auto Scale	-	-	Auto
X Scale Type	Lin	-	-
Amplitude			
Reference Level	0 dBm	0 dBm	
Attenuation	Auto, 10 dB	Auto, 10 dB	
RF Preamp	OFF	OFF	
Y Axis Unit	dBm	dBm	
Y-axis Scale Type	Log	-	
Y scale	10 dB	10 dB	
Max Mixer Lvl	-10 dBm	-10 dBm	
Ref Offset	0 dB	0 dB	
Bandwidth			
RBW	Auto, 10 MHz	Auto, 1 MHz (RBW2)	-
Span/RBW Ratio	Auto, 106	-	-
VBW	Auto, 10 MHz	-	-
VBW/RBW Ratio	Auto, 1	-	-
Filter Type	-	Kaiser	
Sweep			
Sweep Points	801	-	

Parameter Name	GPSA Parameter Value	RTSA Parameter Value (RSA6000-B200)	
		Non-PvT	PvT
Sweep Time	Auto, 148.414 ms	-	
Capture Time	-	Auto, 32 ms	
Sweep Mode	Continuous	Continuous	
Sweep Time Rule	Sweep	-	
Sweep Time Rules	Normal	-	
Trigger			
Trigger Source	Free Run	Free Run	
Trigger Holdoff	OFF, 100 ms	OFF, 100 ms	
Auto Trig	OFF, 100 ms	OFF, 100 ms	
Slope	POS	POS	
Trigger Delay	OFF, 1 μ s	OFF, 1 μ s	
Trigger Level	-25 dBm	-	
Acquisition Times	-	1	
IF Power Trigger Level	-	-25 dBm	
Mask Type	-	Upper Mask	
Trigger Criteria	-	Enter	
Build From Trace	-	Trace 1	
Freq Offset	-	0 Hz	
Amp Offset	-	0 dB	
X Axis Type	-	Fixed	
Y Axis Type	-	Fixed	
Trace			
Selected Trace	Trace 1	Trace 1	-

Parameter Name	GPSA Parameter Value	RTSA Parameter Value (RSA6000-B200)	
		Non-PvT	PvT
Trace Type	Clear Write	Clear Write	-
Detector Type	Normal	Pos Peak	
Detector Auto	ON	ON	
Trace Update	ON	ON	
Trace Display	ON	ON	
Math Function	OFF	OFF	-
Op1	Trace 5	Trace 5	-
Op2	Trace 6	Trace 6	-
Offset	0 dB	0 dB	-
Ref Value	0 dB	0 dB	-
Tracking Generator^[1]			
Tracking Generator	OFF	-	
Amplitude	-40 dBm	-	
Amplitude Offset	0 dB	-	
Normalize	OFF	-	
Reference Level	0 dB	-	
Reference Pos	100%	-	
Reference Trace	OFF	-	
Mode			
Working Mode	GPSA	RTSA	
Meas Setup^[2](GPSA)			
Global CF States			

Parameter Name	GPSA Parameter Value	RTSA Parameter Value (RSA6000-B200)	
		Non-PvT	PvT
Global CF	OFF, 13.25 GHz		
Swept SA Measurement			
Avg Number	100		
Average Type	Log		
Average State	Auto		
Test Limits	OFF		
Selected Limit	Limit1		
Limit State	OFF		
Test Limits	Trace 1		
X Axis Type	Fixed		
Y Axis Type	Fixed		
Margin	Off, 0 dB		
Frequency Interpolation	Lin		
Amplitude Interpolation	Log		
Build From Trace	Trace 1		
Copy from Limit	Limit1		
X Offset	0 Hz		
Y Offset	0 dB		
ACP			
Avg Number	10		
Average Mode	Exponential		
Average State	ON		

Parameter Name	GPSA Parameter Value	RTSA Parameter Value (RSA6000-B200)	
		Non-PvT	PvT
Main Channel Bandwidth	2 MHz		
Adjacent Channel Bandwidth	2 MHz		
Channel Spacing	2 MHz		
C/N Ratio			
Avg Number	10		
Average Mode	Exponential		
Average State	ON		
Offset Frequency	2 MHz		
Noise Bandwidth	2 MHz		
Carrier Bandwidth	2 MHz		
Channel Power			
Average Count	10		
Average Mode	Exponential		
Average State	ON		
TOI			
Avg Number	10		
Average Mode	Exponential		
Average State	ON		
Span	2 MHz		
Harmonic Distortion			
Avg Number	10		
Average Mode	Exponential		

Parameter Name	GPSA Parameter Value	RTSA Parameter Value (RSA6000-B200)	
		Non-PvT	PvT
Average State	ON		
No. of Harmo	10		
Range Table	OFF		
OBW			
Avg Number	10		
Average Mode	Exponential		
Average State	ON		
Limit	OFF, 1.8 MHz		
Max Hold	OFF		
Span	2 MHz		
Power Ratio	99%		
EBW X dB	-10 dB		
T-Power			
Average Count	10		
Average Mode	Exponential		
Average State	ON		
TP Power	Peak		
Start Line	0 μ s		
Stop Line	1 ms		
Limit State	OFF		
Meas Setup^[2](RTSA)			
Normal			
Avg Number	100		

Parameter Name	GPSA Parameter Value	RTSA Parameter Value (RSA6000-B200)	
		Non-PvT	PvT
Test	OFF		
Selected Limit	Limit1		
Limit State	OFF		
Test Trace	Trace 1		
Limit Type	Upper		
X Axis Type	Fixed		
Y Axis Type	Fixed		
Margin	Off, 0 dB		
Frequency Interpolation	Lin		
Amplitude Interpolation	Frequency Interpolation		
Build From Trace	Trace 1		
Copy from Limit	Limit1		
X Offset	0 Hz		
Y Offset	0 dB		
Density			
Avg Number	100		
Auto Couple	-		
Meas Preset	-		
Spectrogram			
Avg Number	100		
Auto Couple	-		
Meas Preset	-		

Parameter Name	GPSA Parameter Value	RTSA Parameter Value (RSA6000-B200)	
		Non-PvT	PvT
PvT			
Avg Number	100		
Density/Spectrogram			
Avg Number	100		
PvT Spectrum			
Avg Number	100		
PvT/Spectrogram			
Avg Number	100		
Marker			
Marker Setup			
Selected Marker	Marker 1		
Marker Mode	Position		
Reference Marker	Marker 2		
Marker Trace	Auto, Trace1		
Marker Frequency	13.25 GHz	13.25 GHz	-
Marker Readout	Frequency		
Readout Auto	On		
Line State	OFF		
Couple Markers	OFF		
Marker Table	Off		
Marker Z	-	1	-
Marker Function			
N dB State	OFF		

Parameter Name	GPSA Parameter Value	RTSA Parameter Value (RSA6000-B200)	
		Non-PvT	PvT
N dB BW	-3.01 dB		
Band Function	OFF		
Marker Counter	OFF		
Gate Time	ON,100 ms		
Peak Search			
Cont Peak	OFF		
Cont Peak Min	OFF		
Peak Table	OFF		
Peak Table Sort	Amplitude		
Peak Table Readout	All		
Display Line	-25 dBm		
Peak Config			
Peak Threshold	ON, -90 dBm		
Peak Excursion	ON, 6 dB		
Threshold Line	OFF		
Pk-Pk Search	Max.		
Display			
Selected Display Line	Display Line1		
Display Line	OFF, -25 dBm		
Selected Freq Line	Frequency Line 1		
Frequency Line	OFF, 1 GHz		
Time Line	OFF, 1 ms		

Parameter Name	GPSA Parameter Value	RTSA Parameter Value (RSA6000-B200)	
		Non-PvT	PvT
Time	300 ms		
Infinite Mode	OFF		
Palette	Warm		
Highest Density Probability	100		
Lowest Density Probability	0		
Curve Nonlinearity	75		
Truncation	OFF		
Display Trace	1		
Trace Display Type	SN		
Trace Couple	OFF		
Reference Hue	0		
Reference Hue Position	100		
Bottom Hue Position	0		
System^[3]			
Power On	Preset		
Power Switch	OFF		
Beeper	OFF		
Screen Brightness	80%		
Fan Speed	56%		
Display Time	ON		

Parameter Name	GPSA Parameter Value	RTSA Parameter Value (RSA6000-B200)	
		Non-PvT	PvT
Auto Calibrate	OFF		
Language	English		

**NOTE**

[1]: This function is only available for the instrument installed with the RSA6000-T08 option.

[2]: This function is only available for RSA6000 installed with the corresponding option.

[3]: Not affected by Preset settings.

8.3 Single/Continue

Press  to set the sweep mode to Single or Continuous. For detailed setting methods, refer to the descriptions in *Sweep Mode*.

8.4 Restart

Press  to restart to sweep. After performing this operation, the sweep or measurement is restarted. The Restart operation aborts the current sweep or measurement. It resets the sweep and trigger systems. All the previously measured data will be remeasured.

9 System Function

9.1 System

Sets the system parameters.

9.1.1 I/O Setting

The analyzer supports the LAN or USB communication interface. In the **System** menu, click or tap **I/O** to enter the I/O setting menu to configure the following parameters.

Network Status

Different prompts will be displayed according to the current network connection status.

- DISCONNECTED!
- CONNECTED

MAC Address

The MAC address of each oscilloscope is unique. When assigning the IP address for the oscilloscope, the system uses the MAC address to identify the instrument.

VISA Address

Displays the VISA address currently used by the the instrument.

IP Configuration Type

The configuration type of the IP address can be DHCP, Auto IP, or Static IP. In different IP configuration types, the configurations for IP address and other network parameters are different.

- **DHCP**

If "DHCP" is selected, the DHCP server in the current network will assign the network parameters (e.g. IP address, Subnet, Gateway, and DNS) for the the instrument.
- **Auto IP**

When "Auto IP" is selected, the instrument will acquire the IP address ranging from "169.254.0.1" to "169.254.255.254" and the subnet mask (255.255.0.0) automatically based on the current network configuration. The "Auto IP" works only when "DHCP" is not selected or connection is failed.
- **Static IP**

If "Static IP" is selected, the instrument is configured with static IP. In this case, you need to disable DHCP and Auto IP manually. At this time, you need to set the IP address, Subnet, Gateway, and DNS manually. At this time, you can self-define the network parameters (e.g. IP address) of the instrument.

- **Set the IP address**

The format of the IP address is nnn.nnn.nnn.nnn. The range of the first segment (nnn) of the address is from 0 to 255 (except 127); wherein, the valid range is from 0 to 223. The range for the other three segments is from 0 to 255. You are recommended to ask your network administrator for an IP address available.

This setting will be saved to the non-volatile memory; if "Power On" is set to "Last", then DHCP and Auto IP are disabled at the next power-on. The instrument will load the preset IP address automatically.

- **Set the subnet mask**

The format of the subnet mask is nnn.nnn.nnn.nnn. Wherein, the range of "nnn" is from 0 to 255. You are recommended to ask your network administrator for a subnet mask available.

This setting will be saved in the non-volatile memory; if "Power On" is set to "Last", then DHCP and Auto IP are disabled at the next power-on. The instrument will load the preset subnet mask automatically.

- **Set the default gateway**

You can set this parameter in Static IP mode. The format of the gateway is nnn.nnn.nnn.nnn. The range of the first segment (nnn) is from 0 to 223 (except 127), and the range for the other three segments is from 0 to 255. You are recommended to ask your network administrator for a gate address available.

This setting will be saved to the non-volatile memory; if "Power On" is set to "Last", then DHCP and Auto IP are disabled at the next power-on. The instrument will load the preset gateway automatically.

- **Set the DNS address**

You can set this parameter in Static IP mode. The format of the DNS address is "nnn.nnn.nnn.nnn". The range for the first segment (nnn) of the address is from 0 to 223 (except 127); and the range for the other three segments is from 0 to 255. You are recommended to ask your network administrator for an address available.

Generally, you do not need to set the DNS, therefore this parameter setting can be ignored.

**TIP**

- When the three IP configuration types are all turned on, the priority of the parameter configuration from high to low is "DHCP", "Auto IP", and "Static IP".
- The three IP configuration types cannot be all turned off at the same time.

mDNS

Click or tap the ON/OFF tab for **mDNS** to enable or disable the multicast Domain Name System (mDNS). This system is used to provide the function of DNS server for service discovery in a small network without a DNS server.

Host Name

If mDNS is enabled, you need to configure the mDNS host name, supporting inputting a maximum of 26-byte strings.

Apply the Network Parameter Setting

Click or tap **Apply** to validate the current network parameter setting.

Reset the Communication Interface

Click or tap **Reset**, then the prompt message "Are you sure to reset interface settings" is displayed. Click or tap **Confirm** to confirm resetting interface settings.

9.1.2 Basic Settings

In the **System** menu, click or tap **Setup** to enter the basic setting menu.

Language

This product supports menus in multiple languages. Both Chinese and English are available for the display of the help information, prompt messages, and interface. Click or tap the drop-down button of **Language** to select the specified system language from the drop-down list.

Power On

You can set the system configuration to be recalled when the oscilloscope is powered on again after power-off. Click or tap "Preset" or "Last" for **Power On**.

- Last: returns to the setting of the system at last power-off.
- Preset: restores the system to its factory setting.

Power Switch

- OFF: After the analyzer is connected to power, you need to press the Power key on the front panel to power on the instrument.
- ON: After the analyzer is connected to power, it will be powered on automatically.

Beeper

Click or tap the ON/OFF tab for **Beeper** to enable or disable the beeper. When the beeper is enabled, you can hear the sound of the beeper when you perform the following operations:

- Press a key or a menu key on the front panel
- Enable the touch screen
- When a prompt message is displayed

Screen Brightness

Drag the slide bar of **Screen Brightness** to set the screen brightness. Its settable range is from 0% to 100%.

Fan Speed

Click or tap the slide bar at the right side of **Fan Speed** to set the fan speed of the instrument. Its settable range is from 0% to 100%.

Display Time

Click or tap the ON/OFF tab for **Display Time** to enable or disable the display of the system time.

The system time (date and time) is displayed in the Notification Area at the lower-right corner of the screen. The date is displayed in "yyyy/mm/dd" format, and the time is displayed in "hh:mm:ss" format. When you save the waveform, the output file will contain the time information. Users can set the system time.

- **Date:** Click or tap the "Date" area, then the date setting interface is displayed. Select a proper date, then click or tap **Confirm** to confirm the date modification.
- **Time:** Click or tap the "Time" area, then the time setting interface is displayed.
 - Click or tap the Hour/Minute number and then drag the hour/minute hand to modify the time.
 - After setting, click or tap **Confirm** to confirm the setting.

9.1.3 About this Spectrum

In the **System** menu, click or tap **About**, and then you can view the model, version, and other information about this spectrum analyzer in **About** menu.

- **Model**
Indicates the product model.
- **Serial number**

Indicates the serial number of the product, the unique identification for the product.

- **Firmware**

Indicates the firmware version number of the product.

- **Hardware**

Indicates the hardware version number of the product.

- **Build**

Indicates the creation time for the software version.

- **Android.Build**

Indicates the creation time of the Android operating system.

- **Android.Version**

Indicates the version number of the Android operating system. For example, 7.1.0.

- **Launcher**

Indicates the desktop UI version number of the Android operating system.

- **WebControl**

Indicates the version number of browser remote control module.

- **Upgrade**

Click or tap **Upgrade**, and the file management interface is displayed. Select the desired upgrade file to upgrade the system. For detailed operations, refer to the descriptions in *Update*.

9.1.4 Options

In the "System" menu, click or tap **Options**, then all the options that have currently been installed can be displayed. For the procedures of installing the option, refer to descriptions in *To View the Option and the Option Installation*.

9.1.5 Calibration

1. Calibrate Now

Click or tap this menu, and the analyzer will use the internal calibration source to perform the self-calibration immediately.

2. Auto Calibrate

Enables or disables auto self-calibration. If auto self-calibration is enabled, the analyzer will perform one self-calibration after it is launched.

9.2 File

RSA6000 series spectrum analyzer allows you to save various types of files to the internal or external memory, and recall them when necessary.

Click or tap  > **File** to enter the file management interface.

9.2.1 File Management

Click or tap **File** to enter the file management interface. You can touch the screen or use the mouse to click on the screen to select the corresponding file or folder. Displays all the files with the specified file types. When you select a file, you can click or tap **Rename**, **Cut**, **Copy**, **Paste**, **Cancel**, **Delete**, or **Safe Clear** to perform the specified operation.

The available file types include: State, Trace+State, Measurement Data, Limit, Screen Image, FMT, and Amplitude Correction. The descriptions for various file types are shown in the following table.

File Type	Format	Suffix Name
State	BIN	.sta
Trace+State	BIN	.trs
Measurement Data	CSV	.csv
Limit	CSV	.csv
Amplitude Correction	CSV	.csv
Screen Image	IMAGE	.jpg/bmp/png
FMT	CSV	.csv

NOTE

RSA6000 can only recognize files whose filenames consist of Chinese characters, English letters, or numbers. If the filename or folder name contains strings other than the above mentioned characters, the file or the folder might not be displayed normally in the file manager interface.

9.2.2 Copy

Copies the currently selected file or folder.

9.2.3 Cut

Cuts the currently selected file or folder from the specified path.

9.2.4 Paste

Pastes the file or folder.

When the current path has contained a file or folder whose name is the same as the one that you want to paste, after you perform the paste operation, the original file or folder will be overwritten.

9.2.5 Rename

Renames a file that has been stored. After you select a file, click or tap this menu name to input a new filename.

9.2.6 Delete

Deletes the selected file.

9.2.7 New Folder

Creates a folder under the current directory, and the file is named with a default filename. To modify this filename, click or tap **Rename** to rename the file.

9.2.8 Safe Clear

Click or tap **Safe Clear**, then a prompt message "Confirm Safe Clear?" is displayed. Click or tap **Confirm** to clear all the saved files from the internal memory. Click or tap **Cancel** to cancel safe clear operation.

9.3 Recall

RSA6000 allows you to recall various types of files from the internal or external storage memory.

Click or tap  > **Recall** to enter the file recalling menu. The available file types include: State and Measurement Data.

9.3.1 State

Click or tap **State** to enter the state recalling menu. The state can be recalled from the register or the file.

1. Load from File

Click or tap **Load from File** to enter the file management interface. Select a file and then click or tap **Confirm** to confirm loading the specified file.

2. Register1 through Register16

When any one of the items from Register1 to Register16 is selected, the state of the specified register will be recalled.

9.3.2 Trace & State

Click or tap **Trace & State** to enter the trace & state recalling menu. The state of the instrument and the selected trace can be recalled from the register or the file.

1. Load from File

Click or tap **Load from File** to enter the file management interface. Select a file to be loaded and then click or tap **Recall** to recall the file.

2. Select Trace

When any one of the items from Trace1 to Trace6 is selected, the specified trace line is recalled.

3. Register1 through Register16

When any one of the items from Register1 to Register16 is selected, the state of the specified register will be recalled.

9.3.3 Measurement Data

Click or tap **Meas Data** to enter the measurement data recalling menu.

1. Load from File

Click or tap **Load from File** to enter the file management interface. Select a file and then click or tap **Confirm** to confirm loading the specified file.

2. Measure Type

Selects the measurement data type to be loaded.

9.3.4 Limit

Click or tap **Limit** to enter the limit line recalling menu.

1. Load from File

Click or tap **Load from File** to enter the file management interface. Select a file and then click or tap **Confirm** to confirm loading the specified file.

2. Select Limit

When any one of the items from Limit1 to Limit6 is selected, the specified limit line is recalled.

9.3.5 FMT (only available for RTSA)

Click or tap **FMT** to enter the FMT recalling menu.

Load from File

Click or tap **Load from File** to enter the file management interface. Select a file to be loaded and then click or tap **Recall** to recall the file.

9.3.6 Amplitude Correction

Click or tap **Correction** to enter the amplitude correction recalling menu. Select the amplitude correction type (Antenna, Cable, Other, and User) to load it from the specified path. The data will be loaded in .csv format. They are separated with a comma, and this is convenient for you to analyze the data in software like Excel.

9.4 Save

RSA6000 allows you to save various types of files to the internal or external memory.

Click or tap  > **Save** to enter the file saving interface. The available file types include: State, Preset, Trace+State, Measurement Data, Limit, FMT, Correction, and Screen Image.

9.4.1 State

Click or tap **State** to enter the state saving menu. The state can be saved to the register or the file.

1. Save to File

Click or tap **Save to File** to save the current state in the default filename or user-defined filename.

2. Register1 through Register16

When any one of the items from Register1 to Register16 is selected, the current state of the instrument will be saved to the corresponding register. The register supports quick save and recalling instrument state. The register menu displays the time for saving the instrument state.

9.4.2 Preset

1. Select Preset

Click or tap **Select Preset** to select the desired preset settings. The available choices include "Default", "User1", "User2", "User3", "User4", "User5", and "User6".

2. Register1 through Register16

When any one of the items from Register1 to Register16 is selected, the current state of the instrument will be saved to the corresponding register. The register supports quick save and recalling instrument state. The register menu displays the time for saving the instrument state.

9.4.3 Trace & State

Click or tap **Trace & State** to enter the trace & state saving menu. The state of the instrument and the selected trace can be saved to the register or the file.

1. Save to File

Saves the current state in the default filename or user-defined filename.

2. Select Trace

Selects the trace to be saved. You can select any single trace from Trace1 to Trace6.

3. Register1 through Register16

When any one of the items from Register1 to Register16 is selected, the current state of the instrument will be saved to the corresponding register. The register supports quick save and loading instrument state. The register menu displays the time for saving the instrument state.

9.4.4 Measurement Data

Click or tap **Meas Data** to enter the measurement data saving menu. The selected measurement data type (raw data or measurement results) can be saved to the specified file. The data will be saved in .csv format. They are separated with a comma, and this is convenient for you to use the Excel to analyze the data.

1. Save to File

Click or tap this menu to save the currently selected type of measurement data in the default filename or user-defined filename.

2. Measure Type

Selects the measurement data type to be saved. The measurement data types supported by the instrument include raw data and measurement results.

9.4.5 Limit

Click or tap **Limit** to enter the limit line saving menu. The selected limit line is saved to the file.

1. Save to File

Click or tap **Save to File** to save the currently selected limit line in the default filename or user-defined filename.

2. Select Limit

Selects the limit line to be saved. You can select any one of the limit lines (from Limit1 to Limit6).

9.4.6 FMT (only available for RTSA)

Click or tap **FMT** to enter the FMT file saving menu. Save the selected FMT file to the file.

Click or tap **Save to File** to save the currently selected FMT file in the default filename or user-defined filename.

9.4.7 Amplitude Correction

Click or tap **Correction** to enter the amplitude correction saving menu. Select the specified amplitude correction type (Antenna, Cable, Other, and User) to save to the specified path. The data will be saved in .csv format. They are separated with a comma, and this is convenient for you to analyze the data in software like Excel.

9.4.8 Screen Image

Click or tap **Screen** to enter the screen saving menu. You can also click or tap  on the quick operation toolbar to quick save the screen image.

1. Save to File

Click or tap **Save to File** to save the current screenshot in the default filename or user-defined filename.

2. Screenshot Info

a. Image Format

Click or tap Format to select the file format of the current screen image to be "*.png", "*.bmp", or "*.jpg".

b. Invert

Click or tap the ON/OFF tab for **Invert** to enable or disable inverting the color of the current screen image.

9.5 Update

This instrument supports local upgrade and online upgrade.

1. Click or tap  > **Update**, then the File Management interface is displayed. Select the update file. For detailed operations, refer to the descriptions in *File*.
2. Click or tap **Confirm** to complete the local upgrade.





9.6 Help Menu

The built-in help file provides information about the functions and menu

introductions of the instrument. Click or tap  > **Help** to enter the help system.

You can get its help information by clicking on the link for the introduction of the specified function.



9.7 Shutdown

- Click or tap the function navigation icon  at the lower-left corner of the screen to enter the function navigation. Click or tap **Shutdown** to shut down the instrument. Then, a prompt message "Are you sure to shutdown?" is displayed. Click or tap **Confirm** to confirming shutting down the instrument.
- Press down the power key , then a prompt message "Are you sure to shutdown?" is displayed. Click or tap **Confirm** to confirming shutting down the instrument.
- Press the power key  continuously for two times to turn off the instrument.
- Long press the power key  for three seconds to turn off the instrument.

9.8 Restart

Click or tap the function navigation icon  at the lower-left corner of the screen to enter the function navigation. Click or tap **Restart** to restart the instrument. Then, a prompt message "Are you sure to restart?" is displayed. Click or tap **Confirm** to restart the instrument.

9.9 Auto

Click or tap the function navigation icon  at the lower-left corner of the screen, then click or tap **Auto** to start auto setting of the spectrum analyzer. You can also press  on the front panel to enable auto setting of the analyzer.

10 Remote Control

The instrument can be remotely controlled in the following several methods:

- **User-defined Programming**

You can program and control the instrument by using the SCPI (Standard Commands for Programmable Instruments) commands. For details about the SCPI commands and programming, refer to *Programming Guide*.

- **PC Software**

You can use the PC software to send commands to control the instrument remotely. RIGOL Ultra Sigma is recommended. You can download the software from RIGOL official website (<http://www.rigol.com>).

Operation Procedures:

- Set up communication between the instrument and PC.
- Run Ultra Sigma and search for the instrument resource.
- Open the remote command control panel to send commands.

- **Web Control**

This instrument supports Web Control. Connect the instrument to the network, then input the IP address of the instrument into the address bar of the browser of your computer. The web control interface is displayed. Click Web Control to enter the web control page. Then you can view the display of the real-time interface of the instrument. Through the Web Control, you can migrate the device control to the control terminals (e.g. PC, mobile phone, iPad, and other smart terminals) to realize remote control of the instrument.

This instrument can be connected to the PC via the USB HOST interface or LAN interface to set up communication and realize remote control. The remote control can be realized by using SCPI (Standard Commands for Programmable Instruments) commands.

This chapter will illustrate how to use the RIGOL Ultra Sigma software to remotely control the instrument via various interfaces.

CAUTION



Before setting up communication, please turn off the instrument to avoid causing damage to the communication interfaces.

10.1 Remote Control via USB

1. Connect the device

Use the USB cable to connect the rear-panel USB DEVICE interface of the instrument to the USB HOST interface of the PC.

2. Search for the device resource

Start up Ultra Sigma and the software will automatically search for the resource currently connected to the PC via the USB interface. You can also click **USB-TMC** to search for the resource.

3. View the device resource

The resources found will appear under the "RIGOL Online Resource" directory, and the model number and USB interface information of the instrument will also be displayed.

4. Control the instrument remotely

Right-click the device resource name and select "SCPI Panel Control" to open the remotely command control panel. Then you can send commands and read data through the panel. For details about the SCPI commands and programming, refer to the Programming Guide of this instrument.

10.2 Remote Control via LAN

1. Connect the device

Use the network cable to connect the instrument to your local area network (LAN).

2. Configure network parameters

Configure the network parameters of the instrument in **Utility>IO** menu.

3. Search for Search device resource

Start up Ultra Sigma and click **LAN** to open the panel as shown in the figure below. Click **Search** and the software searches for the instrument resources currently connected to the LAN and the resources found are displayed at the right section of the window as shown in the figure below. Click **OK** to add it.

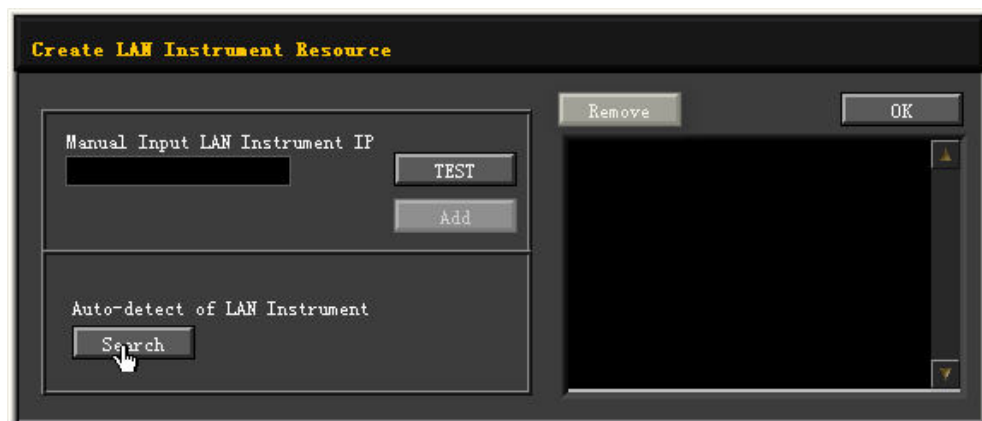

Besides, you can input the IP address of the instrument manually into the text field under "Manual Input LAN Instrument IP", then click **TEST**. If the instrument passes

the test, click **Add** to add the instrument to the LAN instrument resource list in the right section; if the instrument fails the test, please check whether the IP address that you input is correct, or use the auto search method to add the instrument resource.

4. View the device resource

The resources found will appear under the "RIGOL Online Resource" directory.

5. Control the instrument remotely

Right-click the device resource name and select "SCPI Panel Control" to open the remotely command control panel. Then you can send commands and read data through the panel.

6. Load LXI webpage

As this instrument conforms to LXI CORE 2011 DEVICE standards, you can load LXI web page through Ultra Sigma (right-click the instrument resource name and select "LXI-Web"). Various important information about the instrument (including the model, manufacturer, serial number, description, MAC address, and IP address) will be displayed on the web page. You can also directly input the IP address of the instrument in the address bar of the PC browser to load the LXI web page.

11 Troubleshooting

1. When I power on the instrument, the instrument stays black and does not display anything.

- a. Check whether the power is correctly connected.
- b. Check whether the power key is really pressed.
- c. Check whether the fuse is blown. If you need to replace the fuse, use only the specified fuse that conforms to the product.
- d. Restart the instrument after finishing the above inspections.
- e. If the problem still persists, please contact RIGOL.

2. The USB storage device cannot be recognized.

- a. Check whether the USB storage device can work normally when connected to other instruments or PC.
- b. Make sure that the USB storage device is FAT32 format and flash type. The instrument doesn't support hardware USB storage device.
- c. After restarting the instrument, insert the USB storage device again to check whether it can work normally.
- d. If the USB storage device still cannot work normally, please contact RIGOL.

3. The touch functions cannot be used normally.

- a. Check whether you have locked the touch screen. If yes, unlock the touch screen.
- b. Check whether the screen or your finger is stained with oil or sweat. If yes, please clean the screen or dry your hands.
- c. Check whether there is a strong magnetic field around the instrument. If the instrument is close to the strong magnetic field (e.g. a magnet), please move the instrument away from the magnet field.
- d. If the problem still persists, please contact RIGOL.

12 Appendix

12.1 Appendix A: Options and Accessories

	Description	Order No.
Model	Real-time Spectrum Analyzer, 5 kHz to 8.5 GHz	RSA6085
	Real-time Spectrum Analyzer, 5 kHz to 14 GHz	RSA6140
	Real-time Spectrum Analyzer, 5 kHz to 26.5 GHz	RSA6265
Standard Accessory	Power Cord	-
Options	Vector Signal Analysis Application Software	RSA6000-VSA
	EMI Measurement Application Software	RSA6000-EMI
	Analog Demodulation Application Software	RSA6000-ADM
	Preamplifier (PA), 8.5 GHz	RSA6000-P08
	Preamplifier (PA), 14 GHz	RSA6000-P14
	Preamplifier (PA), 26.5 GHz	RSA6000-P26
	200 MHz Analysis Bandwidth	RSA6000-B200
	200 MHz Real-time Bandwidth	RSA6000-RB200
	Advanced Measurement Kit	RSA6000-AMK
	8.5 GHz Tracking Generator Output	RSA6000-T08
Optional Accessories	DSA utility kit. Refer to Note[1] for details.	DSA Utility Kit
	RF adaptor kit. Refer to Note[2] for details.	RF Adaptor Kit
	Includes: 50 Ω to 75 Ω adaptor (2pcs)	RF CATV Kit
	Includes: 6 dB attenuator (1pcs), 10 dB attenuator (2pcs)	RF Attenuator Kit
	30 dB high-power attenuator, with the max. power of 100 W	ATT03301H
	N(M)-N(M) RF Cable	CB-NM-NM-75-L-12G
	N(M)-SMA(M) RF Cable	CB-NM-SMAM-75-L-12G
	Near-field Probe	NFP-3
	Rack Mount Kit	RM3031
	USB Cable x1	CB-USBA-USBB-FF-150

**NOTE**

- For all the mainframes, accessories, and options, please contact the local office of RIGOL.
- [1]: Includes N-SMA cable, BNC-BNC cable, N-BNC adaptor, N-SMA adaptor, 75 Ω -50 Ω adaptor, 900 MHz/1.8 GHz antenna (2pcs), 2.4 GHz antenna (2pcs)
- [2]: Includes: N(F)-N(F) adaptor (1pcs), N(M)-N(M) adaptor (1pcs), N(M)-SMA(F) adaptor (2pcs), N(M)-BNC(F) adaptor (2pcs), SMA(F)-SMA(F) adaptor (1pcs), SMA(M)-SMA(M) adaptor (1pcs), BNC T type adaptor (1pcs), 50 Ω SMA load (1pcs), 50 Ω BNC impedance adaptor (1pcs)

12.2 Appendix B: Warranty

RIGOL TECHNOLOGIES CO., LTD. (hereinafter referred to as RIGOL) warrants that the product mainframe and product accessories will be free from defects in materials and workmanship within the warranty period. If a product proves defective within the warranty period, RIGOL guarantees free replacement or repair for the defective product.

To get repair service, please contact your nearest RIGOL sales or service office.

There is no other warranty, expressed or implied, except such as is expressly set forth herein or other applicable warranty card. There is no implied warranty of merchantability or fitness for a particular purpose. Under no circumstances shall RIGOL be liable for any consequential, indirect, ensuing, or special damages for any breach of warranty in any case.

Index

C

Center Frequency [33](#)

R

RBW [47](#)

V

VBW [47](#)

Video Bandwidth [47](#)

Boost Smart World and Technology Innovation

Industrial Intelligent
Manufacturing



Semiconductors



Education &
Research

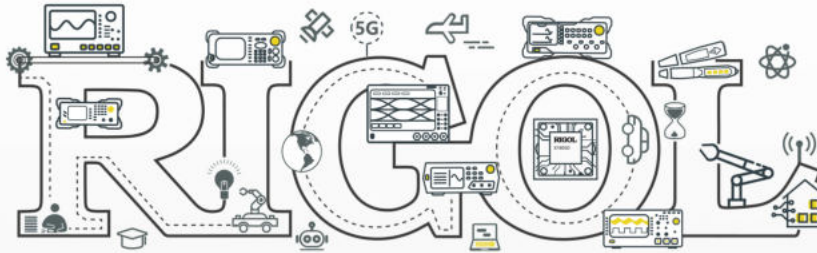

Communication

System Integration



New Energy



- 5G Cellular-5G/WIFI
- UWB/RFID/ ZIGBEE
- Digital Bus/Ethernet
- Optical Communication

- Digital/Analog/RF Chip
- Memory and MCU Chip
- Third-Generation Semiconductor
- Solar Photovoltaic Cells

- New Energy Automobile
- PV/Inverter
- Power Test
- Automotive Electronics

*Provide Testing and Measuring Products
and Solutions for Industry Customers*

HEADQUARTER

RIGOL TECHNOLOGIES CO., LTD.
No.8 Keling Road, New District,
Suzhou, JiangSu, P.R.China
Tel: +86-400620002
Email: info-cn@rigol.com

JAPAN

RIGOL JAPAN CO., LTD.
5F, 3-45-6, Minamiotsuka, Toshima-Ku,
Tokyo, 170-0005, Japan
Tel: +81-3-6262-8932
Fax: +81-3-6262-8933
Email: info.jp@rigol.com

EUROPE

RIGOL TECHNOLOGIES EU GmbH
Friedrichshafener Str. 5
82205 Gilching
Germany
Tel: +49(0)8105-27292-21
Email: info-europe@rigol.com

KOREA

RIGOL KOREA CO., LTD.
5F, 222, Gonghang-daero,
Gangseo-gu, Seoul, Republic of Korea
Tel: +82-2-6953-4466
Fax: +82-2-6953-4422
Email: info.kr@rigol.com

NORTH AMERICA

RIGOL TECHNOLOGIES, USA INC.
10220 SW Nimbus Ave.
Suite K-7
Portland, OR 97223
Tel: +1-877-4-RIGOL-1
Email: sales@rigol.com

For Assistance in Other Countries

Email: info.int@rigol.com