

# **RIGOL**

## **User Guide**

### **PCA1030/PCA2030/PCA1150 /PCA1500 Current Probe**

**May. 2022**  
**RIGOL TECHNOLOGIES CO., LTD.**



# Guaranty and Declaration

## Copyright

© 2022 **RIGOL** TECHNOLOGIES CO., LTD. All Rights Reserved.

## Trademark Information

**RIGOL** is the trademark of **RIGOL** TECHNOLOGIES CO., LTD.

## Publication Number

UGE32101-1110

## Notices

- **RIGOL** products are covered by P.R.C. and foreign patents, issued and pending.
- **RIGOL** reserves the right to modify or change parts of or all the specifications and pricing policies at the company's sole decision.
- Information in this publication replaces all previously released materials.
- Information in this publication is subject to change without notice.
- **RIGOL** shall not be liable for either incidental or consequential losses in connection with the furnishing, use, or performance of this manual, as well as any information contained.
- Any part of this document is forbidden to be copied, photocopied, or rearranged without prior written approval of **RIGOL**.

## Product Certification

**RIGOL** guarantees that this product conforms to the national and industrial standards in China as well as the ISO9001:2015 standard and the ISO14001:2015 standard. Other international standard conformance certifications are in progress.

## Contact Us

If you have any problem or requirement when using our products or this manual, please contact **RIGOL**.

E-mail: [service@rigol.com](mailto:service@rigol.com)

Website: [www.rigol.com](http://www.rigol.com)







## General Safety Summary

### CAUTION



This device is designed to comply with IEC 61010 Safety Standards, and has been thoroughly tested for safety prior to shipment. However, mishandling during use could result in injury or death, as well as damage to the device. Ensure that you have understood the instructions and precautions in the manual before use.

## Safety Terms and Symbols

Before using the device, read the following safety notes carefully.

	<p>The  symbol printed on the device indicates that the user should refer to a corresponding topic in the manual (marked with the  symbol) before using the relevant function.</p> <p>In the manual, the  symbol indicates particularly important information that the user should read before using the device.</p>
	<p>The  symbol printed on the device indicates that only insulated conductors suitable to the voltage of the circuit under test can be measured.</p>

The following symbols in this manual indicate the important cautions and warnings.

 <b>DANGER</b>	<p>Indicates that incorrect operation presents an extreme hazard that could result in serious injury or death to the user.</p>
 <b>WARNING</b>	<p>Indicates that incorrect operation presents a significant hazard that could result in serious injury or death to the user.</p>
 <b>CAUTION</b>	<p>Indicates that incorrect operation presents a possibility of injury to the user or damage to the device.</p>
<b>NOTE</b>	<p>Indicates suggestions related to the performance of the device or correct operation.</p>

---

# Contents

<b>Guaranty and Declaration</b> .....	<b>I</b>
<b>General Safety Summary</b> .....	<b>II</b>
<b>Safety Terms and Symbols</b> .....	<b>II</b>
<b>Safety Precautions</b> .....	<b>IV</b>
<b>Service</b> .....	<b>VIII</b>
<b>Current Probe Overview</b> .....	<b>1</b>
PCA1030/PCA2030 Parts Overview .....	2
PCA1150/PCA1500 Parts Overview .....	3
Parts Introductions .....	4
<b>To Use the Current Probe</b> .....	<b>5</b>
Preparations for Measurement .....	5
Demagnetizing and Zero Adjustment.....	6
Measurement Procedure.....	7
Precautions for Measurement.....	10
<b>Specifications</b> .....	<b>14</b>
PCA1030/PCA2030.....	14
PCA1150.....	15
PCA1500.....	16
<b>Appendix</b> .....	<b>18</b>
Appendix 1 Amplitude-Frequency Characteristics .....	18
Appendix 2 Relation between Max Input Current and Frequency .....	20
Appendix 3 Input Impedance (Typical) .....	22

---

## Safety Precautions

### DANGER

1. Do not measure around a bare conductor. Doing so may result in short-circuit or electric shock. Take measurements at a location on an insulated wire where there is sufficient insulation for the circuit voltage.
2. Refer to **Appendix 2 Relation between Max Input Current and Frequency** when measuring current that includes a high-frequency component. Never measure any current that exceeds the rated current.
3. Using the device in high-frequency or strong magnetic field may cause the device to become abnormally hot, resulting in fire, equipment damage, or burns (see **Specifications**).
4. Observe the following to avoid electric shock and short circuit.
  - 1) Connect the probe to the waveform measurement instrument first, and then connect the probe to the active cable to be measured.
  - 2) When the sensor is opened, do not short circuit the conductor being measured.
  - 3) Be careful to avoid damaging the insulation surface while taking measurements.
  - 4) Before clamping the conductor being measured, make sure that the insulation on the conductor is undamaged. Also, take care not to damage the insulation when clamping the conductor. Any damage to the insulation could cause an electric shock.
  - 5) To prevent fire, burns, or damage of the DUT, pay attention to the following items when measuring high-frequency current or current that has high-frequency components:
    - ✧ Eddy current loss may cause heating of the sensor head.
    - ✧ Dielectric heating may cause heating of cord insulation and other materials.
  - 6) This device should only be connected to the secondary side of a breaker, so the breaker can prevent an accident if a short circuit occurs. Connections should never be made to the primary side of a breaker, because unrestricted current flow could cause a serious accident if a short circuit occurs.
  - 7) Be sure to observe all operating precautions for the waveform measurement instrument and other measurement instruments to which this device is connected.
  - 8) When using a measurement instrument that does not provide

isolation between its input terminals, chassis, or other input terminals, please pay attention to the following points. As shown in the following figure, if a signal is applied to an input terminal other than that to which this device is connected, do not connect the ground terminal of the signal to any non-ground potential. Otherwise, short-circuit current will flow through the current probe from the ground terminal, which could cause an electrical accident or damage.

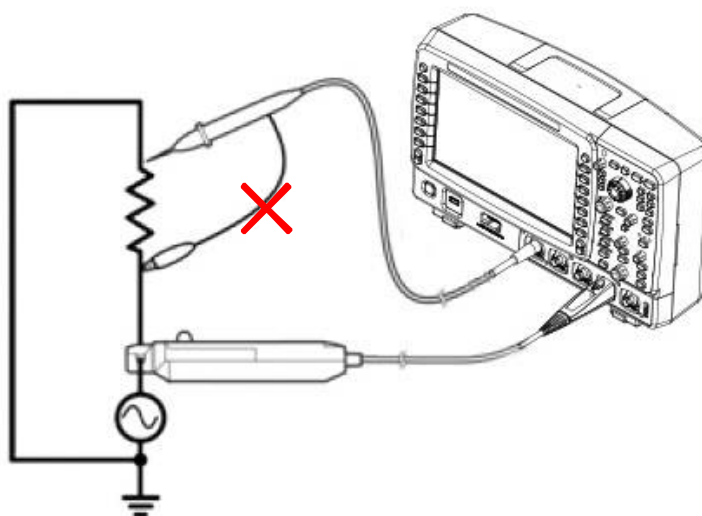

PCA1030/PCA2030

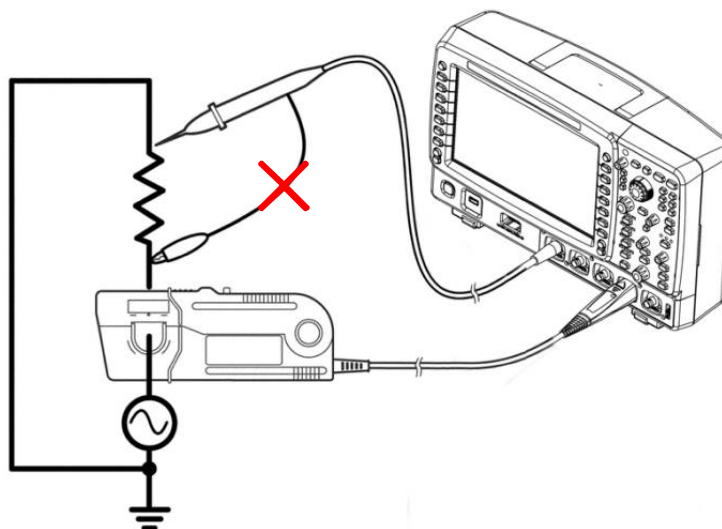

PCA1150/PCA1500

** WARNING**

1. Keep the device dry, and do not take measurements with wet hands. This may cause an electric shock.
2. Do not perform demagnetization operation on the waveform measurement instrument while the conductor being measured is clamped onto the probe. Doing so could damage the circuitry or cause an accident that might result in injury or death.
3. Ensure that the input does not exceed the maximum rated current to avoid device damage, short-circuiting and electric shock resulting from overheating.
4. To avoid electric shock when measuring live lines, wear appropriate protective gear, such as insulated rubber gloves, boots and a safety helmet.

** CAUTION**

1. To avoid damage to the device, protect it from vibration or shock during transport and handling, and be especially careful to avoid falling.
2. This probe should be installed and operated indoors only, at the ambient temperature between 0°C and 40°C, in the humidity of 80%RH or less.
3. Do not store or use the device in a place where it could be exposed to direct sunlight, high temperature, humidity, or condensation. Under such conditions, the device may be damaged and insulation may deteriorate so that it no longer meets specifications.
4. This device is not designed to be entirely water-proof or dust-proof. To avoid damage, do not use it in a wet or dusty environment.
5. The sensor head is a precision assembly which includes a molded component, a ferrite core, and a Hall effect element. It may be damaged if subjected to sudden changes in ambient temperature, or mechanical strain or shock, and therefore great care should be exercised in handling it.
6. The gear mating surface of the sensor head are precision ground, and should be treated with care. If the surface is scratched, performance may



---

be impaired.

7. Measurements are degraded by dirt on the gear mating surface of the sensor head, so keep the surface clean with a soft cloth.
8. Foreign substances such as dust on the contact surface of the sensor head can cause resonant sound (refer to the introduction about **resonant sound** in the later section) and degrade measurement, so it should be cleaned with a soft cloth.
9. Do not bend or pull the cables to avoid damaging them.
10. Do not apply a static electricity or other source of high voltage to the sensor. Doing so may damage its internal Hall elements and circuitry.
11. To clean the device, wipe it gently with a soft cloth moistened with water or mild detergent. Never use solvents such as benzene, alcohol, acetone, ether, ketones, thinners or gasoline, as they can deform and discolor the case.
12. When the power is on, keep the sensor closed, except when clamping it onto the conductor to be measured. Otherwise, the gear mating surface of the magnetic core section can be scratched when the sensor is open.
13. Keep the sensor head closed when not in use, to avoid accumulating dust or dirt on the gear mating surface, which could affect its clamp performance.
14. Avoid stepping on or pinching the cable, which could damage the cable insulation.
15. Keep the cables away from heat sources, as bare conductors could be exposed if the insulation melts.

**NOTE**

Correct measurement may be impossible in the presence of strong magnetic fields, such as near transformers and high-current conductors, or in the presence of strong electromagnetic fields such as near radio transmitters.

## Service

When sending the device for repair, pack carefully to prevent damage in transit. Package the device with the cushioning materials to avoid causing damage to the probe. Be sure to attach the detailed failure descriptions about the product. **RIGOL** shall not be responsible for any damage of the probe that occurs during shipment.

A regular calibration is necessary in order to ensure that the current probe can provide correct measurement results with expected accuracy. If you need to calibrate the current probe, contact **RIGOL**.

---

## Current Probe Overview

This device can be directly connected to a BNC input connector of a waveform measurement instrument. Once being clamped on a conductor to be measured through the sensor head, it can capture the current waveform easily.

### Main Features:

- ◆ Highly accurate current detection
- ◆ Easy current measurement
- ◆ Broadband frequency characteristics
  - PCA1030: DC to 50 MHz
  - PCA2030: DC to 100 MHz
  - PCA1150: DC to 10 MHz
  - PCA1500: DC to 2 MHz
- ◆ PCA1030/PCA2030: Compact design, available to measure low current level
- ◆ PCA1150/PCA1500: Large diameter allows high-current measurements
- ◆ Easy protect function at excessive input
- ◆ Unique thin film Hall effect element

## PCA1030/PCA2030 Parts Overview

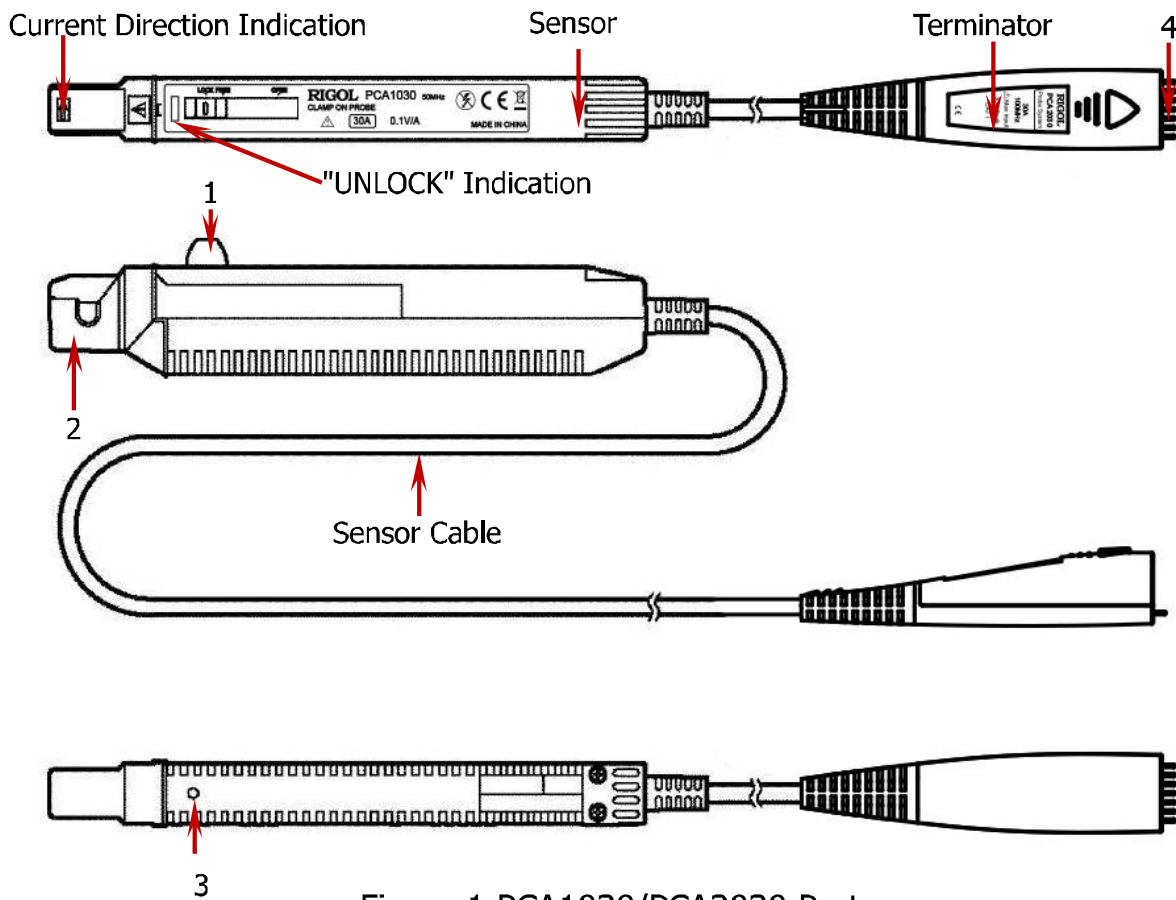

Figure 1 PCA1030/PCA2030 Parts

For the parts from 1 to 4 noted in the above figure, please refer to **Parts Introductions**.

### **NOTE**

In the above figure, the Terminator is connected to the waveform measurement instrument via the output connector. The Terminator will provide power to the current probe when the waveform measurement instrument is powered on.

## PCA1150/PCA1500 Parts Overview

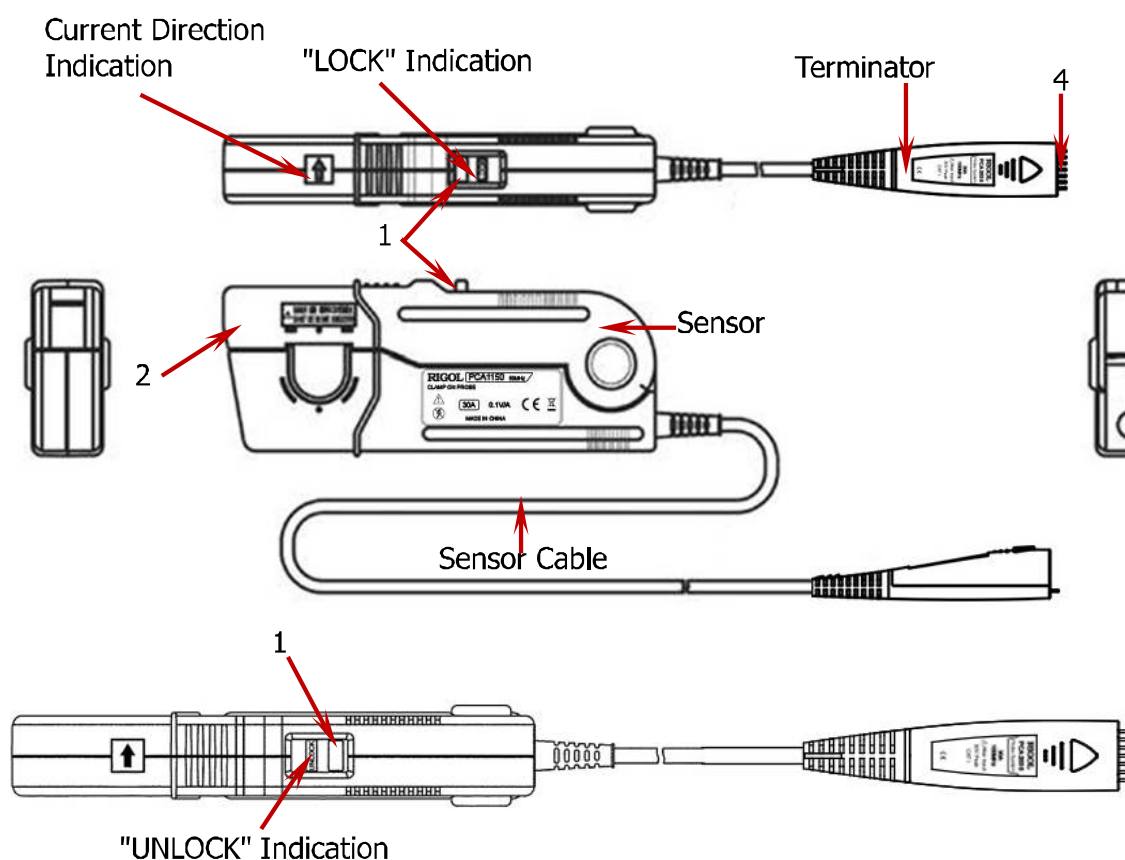

Figure 2 PCA1150/PCA1500 Parts

For the parts (1, 2, 4) noted in the above figure, please refer to **Parts Introductions**.

### **NOTE**

In the above figure, the Terminator is connected to the waveform measurement instrument via the output connector. The Terminator will provide power to the current probe when the waveform measurement instrument is powered on.

---

## Parts Introductions

### 1. Opening lever

It is used to open and lock the current sensor. You are recommended to lock the current sensor when measuring the conductor to avoid danger. For PCA1030/PCA2030, there are OPEN, FREE and LOCK indications on one side of the opening lever. The on/off status of the current sensor is related to the position of the opening lever.

- ✧ When the opening lever is in the OPEN position, the current sensor is open and at this point, the conductor to be measured can be connected to the current sensor;
- ✧ When the opening lever is in the FREE position, the current sensor is closed but not locked;
- ✧ When the opening lever is in the LOCK position, the current sensor is locked and at this point, the UNLOCK indication is covered (cannot be seen).

For PCA1150/PCA1500, there are LOCK and UNLOCK indications on the opening lever. The current sensor is locked when the LOCK indication is displayed on the opening lever (the UNLOCK indication disappears).

### 2. Sensor head

It is used to clamp the conductor under measurement to carry out the actual current measurement. It is a precision assembly that includes a molded component, a ferrite core, and a Hall effect element. It may be damaged if subjected to sudden changes in ambient temperature, or mechanical strain or shock, and therefore great care should be exercised in handling it.

### 3. Coarse adjustment trimmer (Only for PCA1030/PCA2030)

Use this only when the adjustment is outside the zero adjustment range of the waveform measurement instrument. Use a nonconductive screwdriver (e.g. ceramic driver) for adjustment on this coarse adjustment trimmer.

### 4. Output connector

The current waveform of the conductor under measurement is output at a constant gain via this connector to the waveform measurement instrument. This connector can be connected to the BNC input connector of the waveform measurement instrument.

#### **NOTE**

- Since the output impedance of the current probe is 25  $\Omega$  (PCA1030/PCA2030) or 7  $\Omega$  (PCA1150/PCA1500), the current probe must be connected to a waveform measurement instrument that has

an input impedance of at least 1 M $\Omega$ . Accurate measurement is not possible with waveform measurement instrument that has an input impedance of 50  $\Omega$ .

- If using BNC-banana plug adapters or similar connectors to connect to input terminals other than BNC connectors, make sure the polarity is correct in connection.

## To Use the Current Probe

Before using the current probe, make sure to refer to **Safety Precautions**.

### Preparations for Measurement

1. Prepare a set of waveform measurement instrument.
2. Connect the waveform measurement instrument to the AC power source.
3. Connect the output connector of the current probe to the input terminal of the waveform measurement instrument.

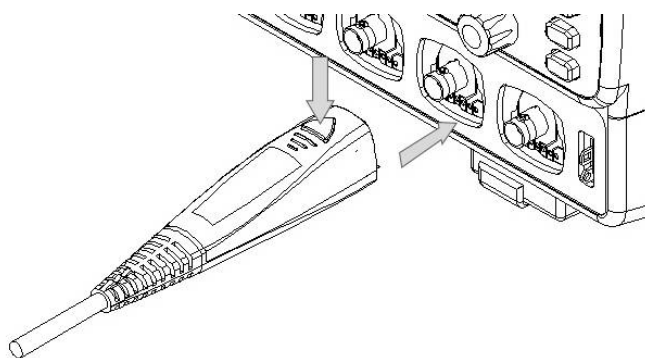

4. Power on the waveform measurement instrument, and check whether the front panel power indicator lights up.
5. Turn on the current probe and wait at least 30 minutes. Immediately after it is powered on, zero drift occurs obviously due to the warm-up and other factors. To ensure the accurate measurement, wait for at least a 30-minute warm-up after turning on the current probe before performing the measurement.

## Demagnetizing and Zero Adjustment

1. With the waveform measurement instrument input at ground, adjust the trace to the zero position.
2. Set the input coupling of the waveform measurement instrument to DC.

### CAUTION

- When disconnecting the output connector from the waveform measurement instrument, be sure to release the lock before pulling out the connector. Forcibly pulling out the connector without releasing the lock or pulling the cable can damage the terminator.
- If using BNC-banana plug adapters or similar connectors to connect to input terminals other than BNC connectors, make sure the polarity is correct in connection.
- Do not demagnetize while the sensor of the current probe is clamping a conductor to be measured. Demagnetizing causes current to flow into the conductor, which may damage components of the circuit to be measured.

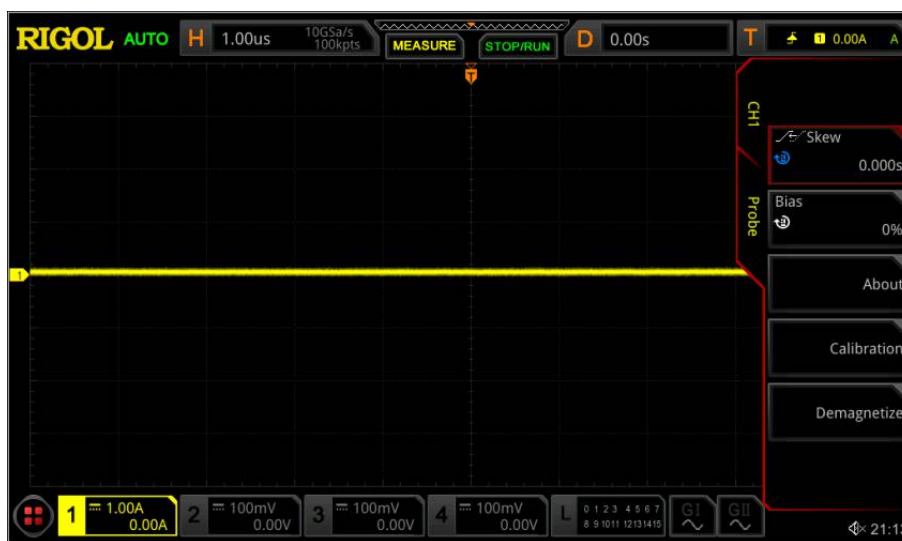

- With the above considerations, as the demagnetized waveform will be generated when the current probe is energized, ensure that no conductor being measured is clamped to the current probe before providing power to the current probe.
3. Make sure the current sensor is locked (for PCA1030/PCA2030, the opening lever should be in the LOCK position; for PCA1150/PCA1500, LOCK should be displayed on the opening lever and UNLOCK should



- disappear).
4. Perform the demagnetization operation on the waveform measurement instrument.
  5. Perform the zero adjustment operation on the waveform measurement instrument to adjust the trace to the zero position.

**NOTE**

For PCA1030/PCA2030, if zero adjustment cannot be achieved through the waveform measurement instrument, try to use the coarse adjustment trimmer to adjust the trace to within the available zero adjustment range of the waveform measurement instrument.

While turning the coarse adjustment trimmer, do not subject it to a thrust. Doing so may cause the trimmer to come off. To turn the trimmer, use a slotted screwdriver whose flat blade is made of non-conductive materials (such as ceramic), 0.4 mm in thickness, 1.8 mm in width, and 10 mm or longer in length.

## Measurement Procedure

1. Check and ensure that the system is safe and the preparations described in the preceding section have been ready.
2. Open the current sensor by pushing the opening lever in the arrow direction shown in the figure below (for PCA1030/PCA2030, the opening lever should be in the OPEN position; for PCA1150/PCA1500, UNLOCK should be displayed on the opening lever and LOCK should disappear).

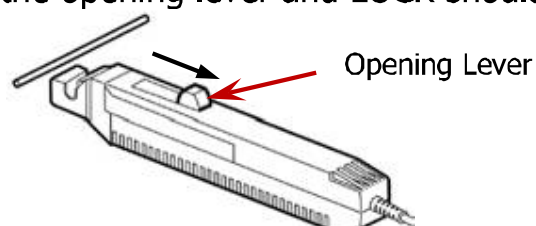

3. Adjust the current sensor to make its current direction indicator align with the actual current direction in the conductor. Clamp the sensor head around the conductor to be measured and put it in the center of the sensor head.
4. Lock the current sensor by pushing the opening lever in the arrow direction shown in the figure below (for PCA1030/PCA2030, the opening

lever should be in the LOCK position; for PCA1150/PCA1500, push the opening lever until LOCK is displayed and UNLOCK disappears).

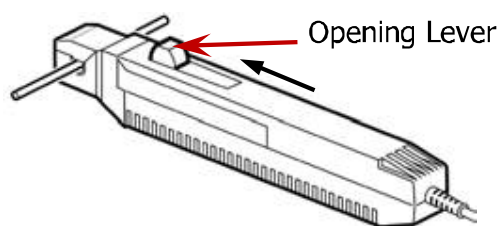

5. It is now possible to monitor the current waveform. The output gain is 0.1 V/A for PCA1030/PCA2030 and 0.01 V/A for PCA1150/PCA1500. The current sensitivity can be derived from the voltage sensitivity of the waveform measurement instrument. For example, for PCA1030, if the voltage sensitivity is 10 mV/div, then the current sensitivity is  $(10 \text{ mV/div}) / (0.1 \text{ V/A}) = 100 \text{ mA/div}$ .

**NOTE**

The current consumption of the current probe depends on the current to be measured. The figure below shows the relation curve between the output current and current consumption.

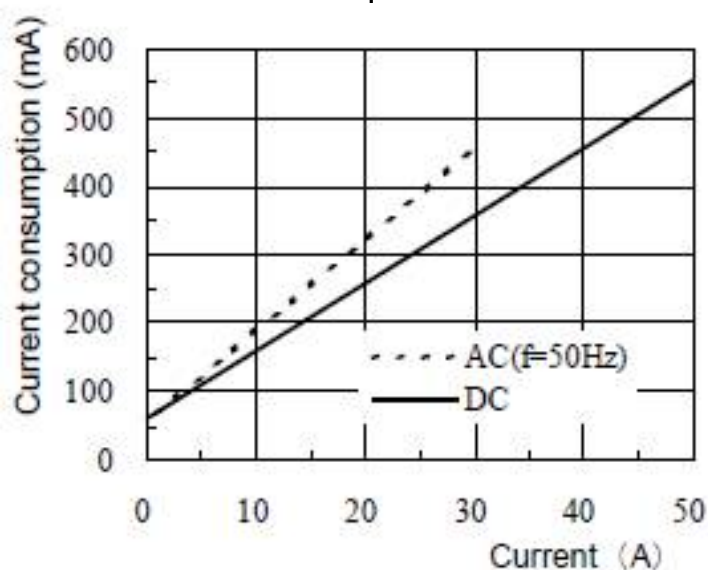

PCA1030

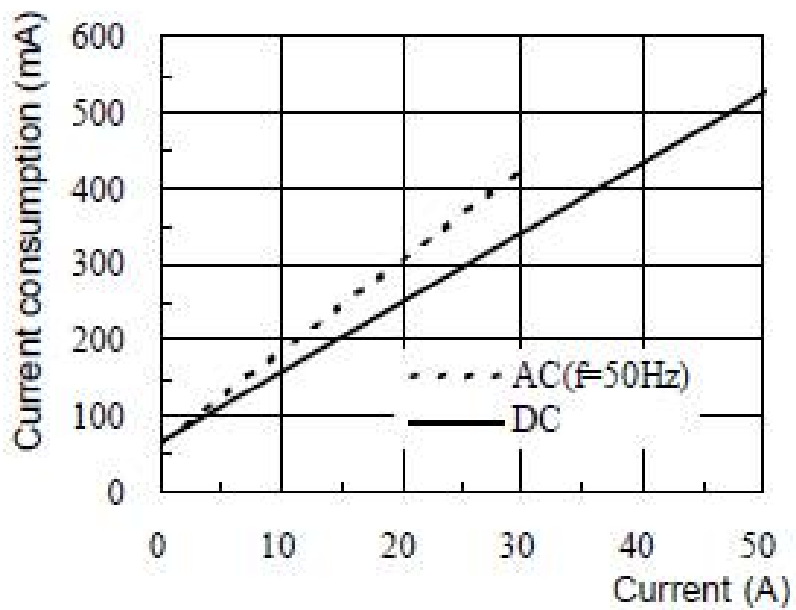

PCA2030

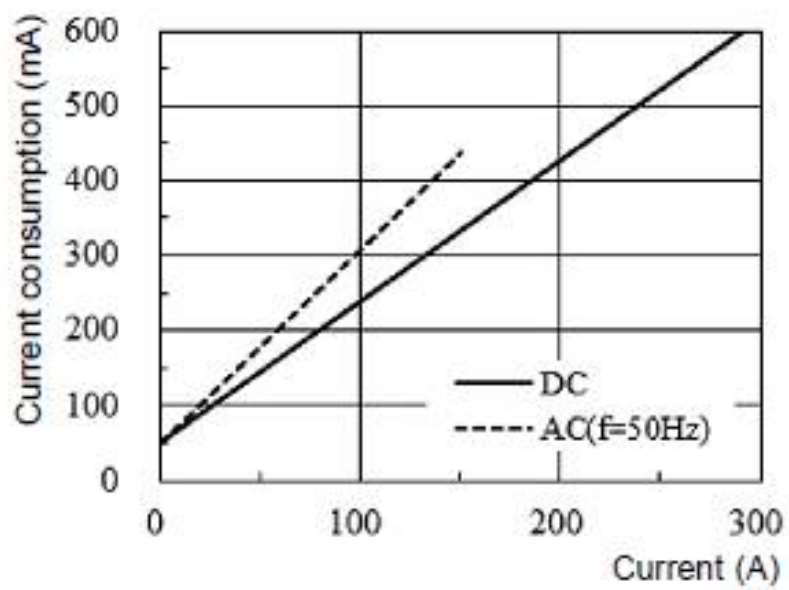

PCA1150

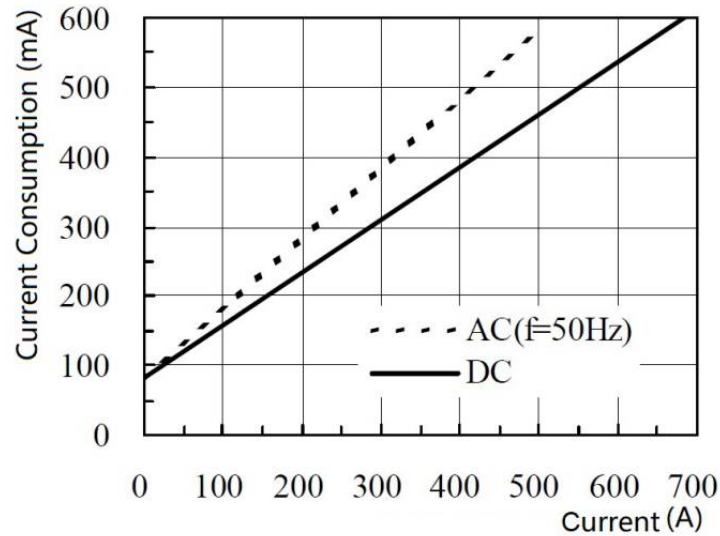

PCA1500

Note: The current consumption is the algebraic sum of the positive and negative current consumption.

## Precautions for Measurement

### ⚠ CAUTION

1. The maximum continuous input range is based on the heat that is internally generated during the measurement. Never input current in excess of this level. Exceeding the rated level may result in damage to the probe.
2. The device may sustain damage from self-heating even at current levels that are lower than the maximum current value defined by the maximum rated current.  
The maximum rated current is a recommended value that assumes sine-wave input under standard conditions. Self-heating may increase if the ambient temperature increases or the measurement current waveform contains other frequency components. Refer to **Appendix 2 Relation between Max Input Current and Frequency**.
3. If excess current is input, generated heat activates a built-in safety function that blocks normal output. If this happens, remove the input immediately (remove the sensor from the conductor being measured, or reduce the input current to zero). Wait until the sensor has had sufficient time to cool before resuming operation.

4. Heating generated during measurement of current with a frequency of 1 kHz or higher is mainly attributed to the self-heating of the sensor head. In this case, the built-in safety function will not be activated. Be careful to avoid accidents, such as a burn by heat, short-circuit, and damage to the sensor.
5. Even if the input current does not exceed the rated continuous maximum, continuous input for an extended period of time may activate the safety circuit to prevent damage resulting from heating of the sensor.
6. At a high ambient temperature, the built-in safety circuit may be activated even if the input current is below the rated continuous maximum.
7. Continuous input of current exceeding the rated maximum or repeated activation of the safety function may result in damage to the device.
8. The maximum input range is indicated by the **Maximum Continuous Input Range**. It is also indicated by another product specification **Maximum Peak Current Value**. Make sure that the input does not exceed the continuous maximum input range in rms.
9. Do not place any unclamped conductor with a current of a frequency of 10 kHz or higher near the sensor head, as shown in the following figure, as current flow in the conductor nearby may cause the temperature of the sensor head increase, leading to damage to the sensor.

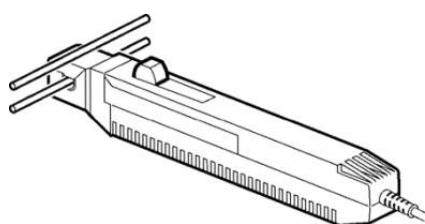

PCA1030/PCA2030

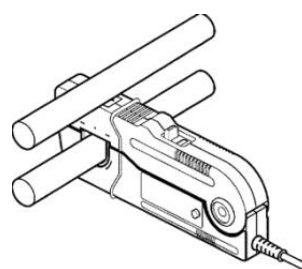

PCA1150/PCA1500

10. When opening the sensor head of the probe, be sure to operate with the opening lever. For PCA1030/PCA2030, if an upper core is forced to open while the sensor head is locked, the open-close mechanism can be damaged.

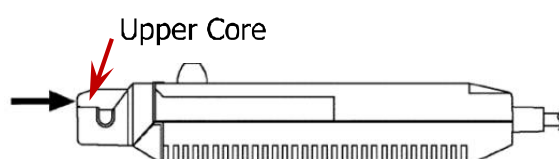

**NOTE**

1. Immediately after powering on, this device may be subject to an appreciable offset drift due to the effect of self-heating. To counteract this, allow the device to warm up for about 30 minutes before carrying out measurement.
2. When performing continuous measurements, it is necessary to be aware that the zero offset voltage will drift due to the impact of some factors such as the changes of the ambient temperature.
3. Under certain circumstances, oscillation may occur if the output connector is connected to the waveform measurement instrument that has been powered on. This does not indicate a malfunction. Oscillation can be stopped and operation restored to normal by opening and closing the clamp.
4. Depending on the amplitude and frequency of the current being measured, the sensor head may emit a resonant sound. This sound may also occur during demagnetizing operation, but it does not represent a malfunction (device failure).
5. If foreign matter becomes adhered to the gear mating surface of the sensor head, a slight gap will appear between its upper and lower layer. In this case, a resonant sound will be produced from the sensor head. Therefore, any foreign matter on the gear mating surface of the sensor head should be removed by using the cleaning method described in this manual.
6. An increase in the volume of the resonant sound during use may indicate that the gap between the upper and lower layer has increased. Since the sensor characteristics may change, it is recommended to calibrate the device.
7. Perform the demagnetization operation on the waveform measurement instrument will generate a demagnetized waveform. Although the waveform may be asymmetry with respect to the zero-volt line, it does not indicate a malfunction.
8. The reading may be affected by the position within the clamp aperture of the conductor being measured. The conductor should be in the center of the clamp aperture.

9. When carrying out measurement, make sure that the sensor head is locked (for PCA1030/PCA2030, the opening lever should be in the LOCK position; for PCA1150/PCA1500, slide the opening lever until the "UNLOCK" indication disappears, and hold it until LOCK appears). If the sensor head is not properly closed, accurate measurement will not be possible.
10. Accurate measurement may be impossible in locations subject to strong external magnetic fields, such as transformers and high current conductors, or in locations subject to strong external electric fields, such as radio transmission equipment.
11. At high frequencies, common mode noise may affect measurements taken on the high voltage side of the circuit. If this occurs, reduce the frequency range of the waveform measurement instrument or clamp onto the low-voltage side of the circuit, as appropriate.

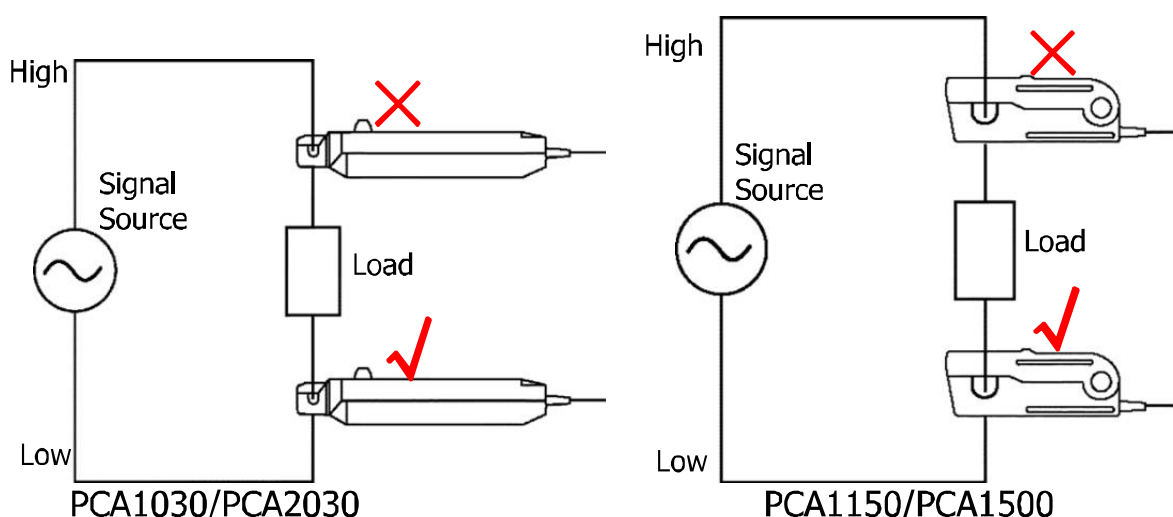

## Specifications

When the device works for at least 30 minutes at  $23^{\circ}\text{C}\pm 5^{\circ}\text{C}$ , the following specifications can be guaranteed.

### PCA1030/PCA2030

<b>Bandwidth</b>	PCA1030: DC to 50 MHz (-3 dB), refer to <b>Appendix 1 Amplitude-Frequency Characteristics</b> (PCA1030) PCA2030: DC to 100 MHz (-3 dB), refer to <b>Appendix 1 Amplitude-Frequency Characteristics</b> (PCA2030)
<b>Rise Time</b>	PCA1030: $\leq 7$ ns PCA2030: $\leq 3.5$ ns
<b>Maximum Continuous Input Range</b>	30Arms, refer to <b>Appendix 2 Relation between Max Input Current and Frequency</b> (PCA1030/PCA2030)
<b>Maximum Peak Current Value</b>	Non-continuous 50A peak
<b>Gain</b>	0.1V/A
<b>Amplitude Accuracy</b>	$\pm 1.0\%$ rdg $\pm 1$ mV, $\leq 30$ Arms $\pm 2.0\%$ rdg, $\leq 50$ A peak (DC, and 45 to 66 Hz, input within continuous maximum input range)
<b>Noise</b>	$\leq 2.5$ mArms (for 20MHz band waveform measurement instrument)
<b>Input Impedance</b>	Refer to <b>Appendix 3 Input Impedance (Typical)</b> (PCA1030/PCA2030)
<b>Temperature Coefficient for Sensitivity</b>	$\leq \pm 2\%$ (during input of 50 Hz, 30 Arms within the range of $0^{\circ}\text{C}$ - $40^{\circ}\text{C}$ )
<b>Maximum Rated Power</b>	8.5 VA
<b>Operating Temperature and Humidity Range</b>	$0^{\circ}\text{C}$ to $40^{\circ}\text{C}$ , $\leq 80\%$ RH (no condensation)
<b>Storage Temperature and Humidity Range</b>	$-10^{\circ}\text{C}$ to $50^{\circ}\text{C}$ , $\leq 80\%$ RH (no condensation)
<b>Location for Use</b>	Indoor, altitude up to 2,000 m, Pollution Degree 2



<b>Effect of External Magnetic Fields</b>	PCA1030: $\leq 20$ mA (DC and 60 Hz, Magnetic field of 400 A/m) PCA2030: $\leq 5$ mA (DC and 60 Hz, Magnetic field of 400 A/m)
<b>Diameter of Conductor Available for Measurement</b>	5 mm
<b>Conductor Available for Measurement</b>	Insulated conductor
<b>Guaranteed Accuracy Period</b>	1 year (opening/closing up to 10,000 times)
<b>Cable Length</b>	Sensor cable: approx. 1.5m
<b>External Dimension</b>	Sensor: approx. 175W $\times$ 18H $\times$ 40D (mm) (excluding protrusions) Terminator: approx. 27H $\times$ 55W $\times$ 18D (mm)
<b>Weight</b>	PCA1030: approx. 230 g PCA2030: approx. 240 g
<b>Accessories</b>	User Guide, Probe Case
<b>Safety</b>	EN61010
<b>EMC</b>	EN61326

## PCA1150

<b>Bandwidth</b>	DC to 10 MHz (-3 dB), refer to <b>Appendix 1 Amplitude-Frequency Characteristics</b> (PCA1150)
<b>Rise Time</b>	$\leq 35$ ns
<b>Maximum Continuous Input Range</b>	150 A, refer to <b>Appendix 2 Relation between Max Input Current and Frequency</b> (PCA1150)
<b>Maximum Peak Current Value</b>	300A peak, non-continuous 500A peak, pulse width $\leq 30$ $\mu$ s
<b>Gain</b>	0.01V/A
<b>Amplitude Accuracy</b>	$\pm 1.0\%$ rdg $\pm 1$ mV, $\leq 150$ A $\pm 2.0\%$ rdg, 150 A to 300 A peak (DC, and 45 Hz to 66 Hz)
<b>Noise</b>	$\leq 25$ mArms (for 20 MHz band waveform measurement instrument)
<b>Input Impedance</b>	Refer to <b>Appendix 3 Input Impedance</b>

**RIGOL**

	<b>(Typical)</b> (PCA1150)
<b>Temperature Coefficient for Sensitivity</b>	$\leq \pm 2\%$ (input: 55 Hz, 150 A, within a range of 0°C-40°C)
<b>Maximum Rated Power</b>	8.5 VA
<b>Operating Temperature and Humidity Range</b>	0°C to 40°C, $\leq 80\%$ RH (no condensation)
<b>Storage Temperature and Humidity Range</b>	-10°C to 50°C, $\leq 80\%$ RH (no condensation)
<b>Location for Use</b>	Indoor, altitude up to 2,000 m, Pollution Degree 2
<b>Guaranteed Accuracy Period</b>	1 year (opening/closing up to 10,000 times)
<b>Effect of External Magnetic Field</b>	$\leq 150$ mA (in a DC or 60 Hz, 400 A/m magnetic field)
<b>Diameter of Conductor Available for Measurement</b>	20 mm
<b>Conductor Available for Measurement</b>	Insulated conductor
<b>Cable Length</b>	Sensor cable: approx. 2 m
<b>External Dimension</b>	Sensor: approx. 176W X 69H X 27D (mm) Terminator: approx. 27H X 55W X 18D (mm)
<b>Weight</b>	Approx. 500 g
<b>Accessories</b>	User Guide, Probe Case
<b>Safety</b>	EN61010
<b>EMC</b>	EN61326

**PCA1500**

<b>Bandwidth</b>	DC to 2 MHz (-3 dB), refer to <b>Appendix 1 Amplitude-frequency Characteristics</b> (PCA1500)
<b>Rise Time</b>	$\leq 175$ ns
<b>Maximum Continuous Input Range</b>	500 Arms, refer to <b>Appendix 2 Relation between Max Input Current and Frequency</b> (PCA1500)

<b>Maximum Peak Current Value</b>	700A peak, non-continuous
<b>Gain</b>	0.01 V/A
<b>Amplitude Accuracy</b>	$\pm 1.0\%$ rdg $\pm 5$ mV, $\leq 500$ Arms $\pm 2.0\%$ rdg, $\leq 700$ A peak (DC, 45 Hz to 66 Hz)
<b>Noise</b>	$\leq 25$ mArms (for BW 20 MHz waveform measuring instrument)
<b>Input Impedance</b>	Refer to <b>Appendix 3 Input Impedance (Typical)</b> (PCA1500)
<b>Temperature Coefficient for Sensitivity</b>	$\leq \pm 2\%$ (during input of 50 Hz, 500 Arms within range of 0°C to 40°C)
<b>Maximum Rated Power</b>	7.2 VA (within maximum continuous input range)
<b>Operating Temperature and Humidity Range</b>	0°C to 40°C, $\leq 80\%$ RH (no condensation)
<b>Storage Temperature and Humidity Range</b>	-10°C to +50°C, $\leq 80\%$ RH (no condensation)
<b>Location for Use</b>	Indoor, altitude up to 2,000 m, Pollution Degree 2
<b>Period of Guaranteed Accuracy</b>	1 year (opening/closing up to 10,000 times)
<b>Effect of External Magnetic Fields</b>	$\leq 800$ mA (in a DC or 60 Hz, 400 A/m magnetic field)
<b>Diameter of Measurable Conductor</b>	20 mm
<b>Measurable Conductor</b>	Insulated conductor
<b>Cable Length</b>	Sensor cable: approx. 2 m
<b>External Dimension</b>	Sensor: approx. 176W X 69H X 27D (mm) Terminator: approx. 27H X 55W X 18D (mm)
<b>Mass</b>	Approx. 520g
<b>Accessories</b>	User Guide, Probe Case
<b>Safety</b>	EN61010
<b>EMC</b>	EN61326

# Appendix

## Appendix 1 Amplitude-Frequency Characteristics

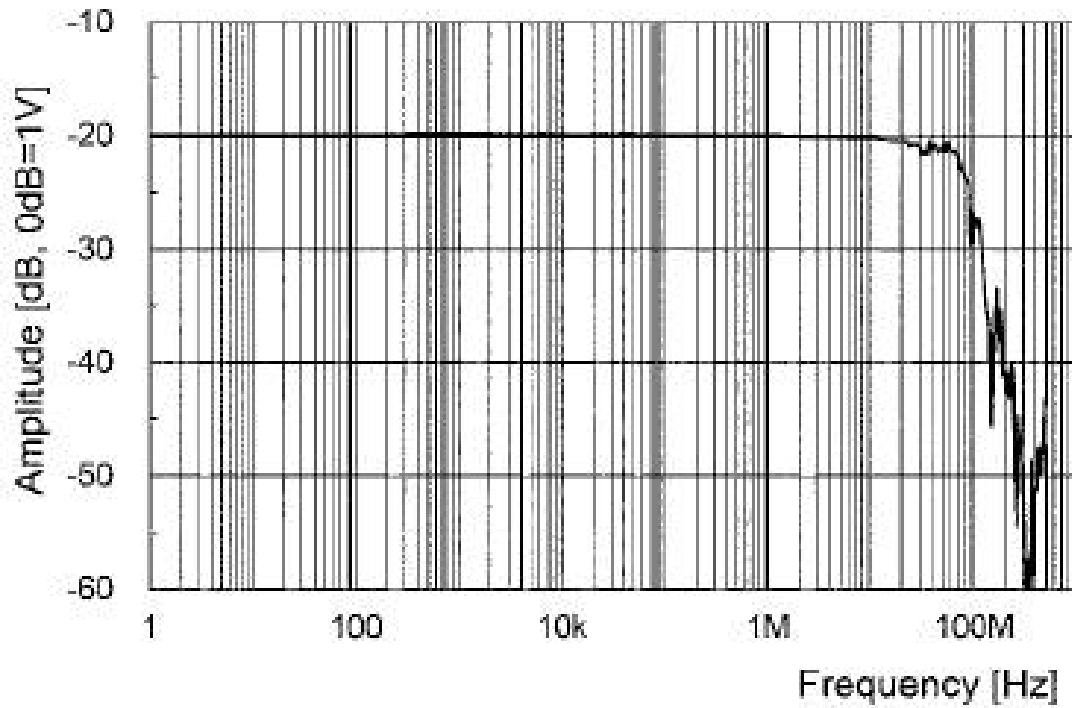

**PCA1030**

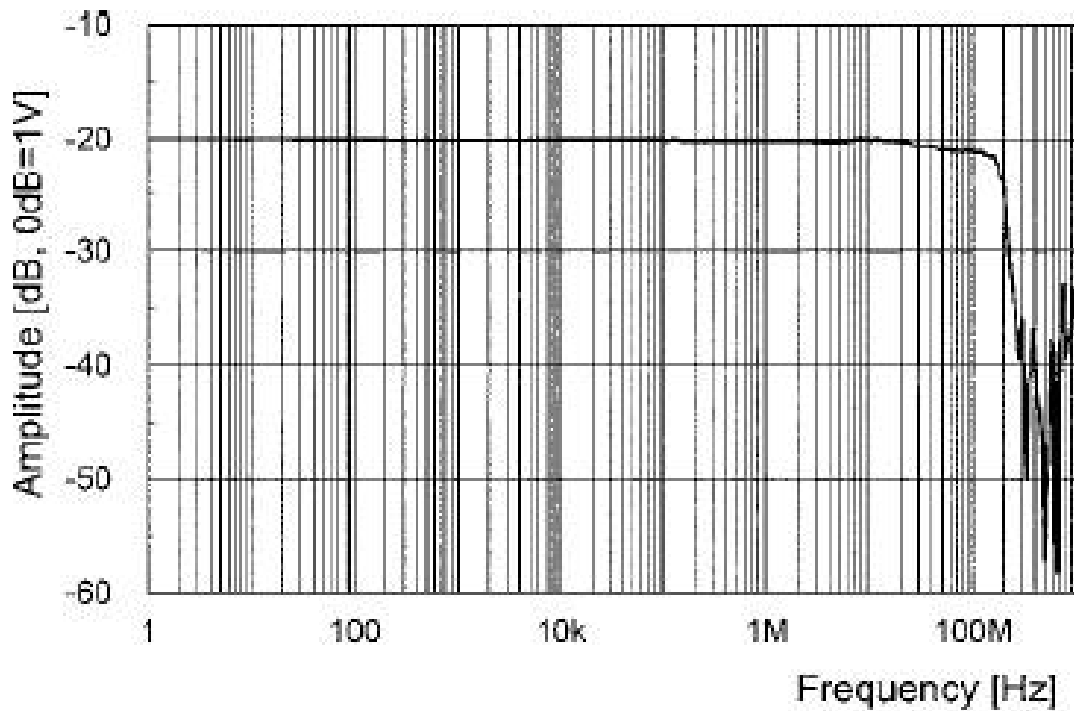

**PCA2030**

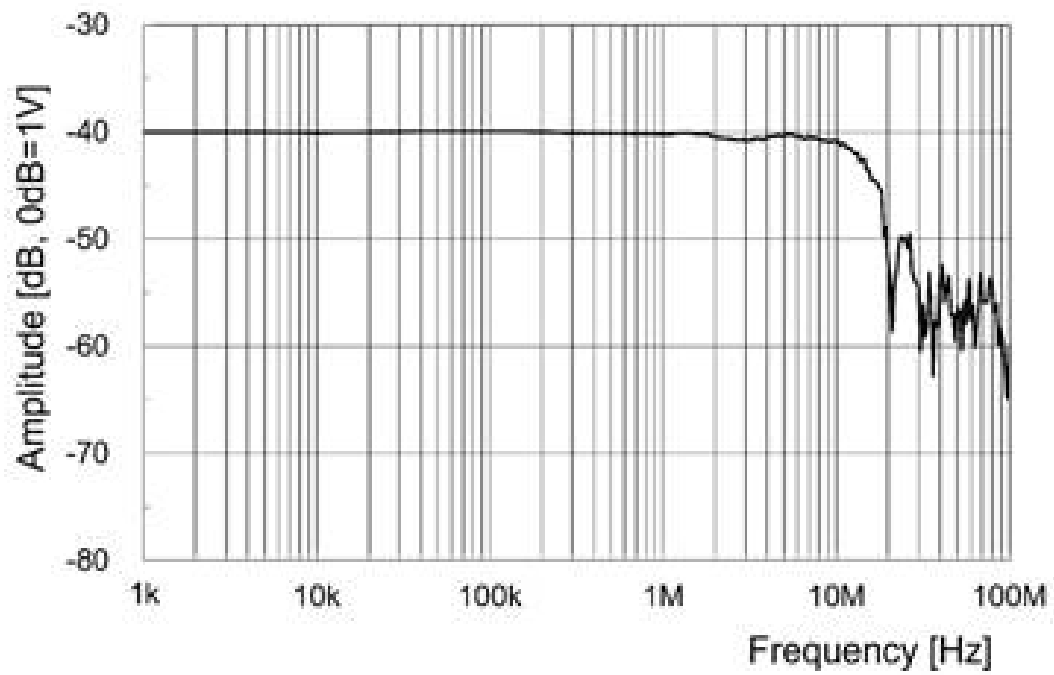
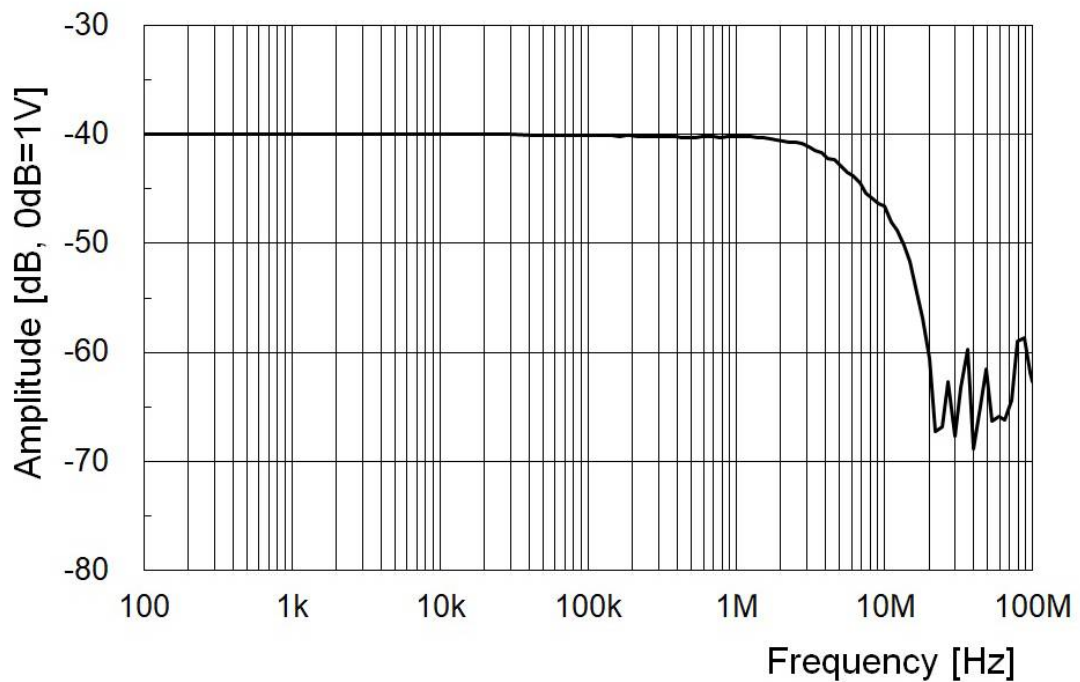
**PCA1150****PCA1500**

## Appendix 2 Relation between Max Input Current and Frequency

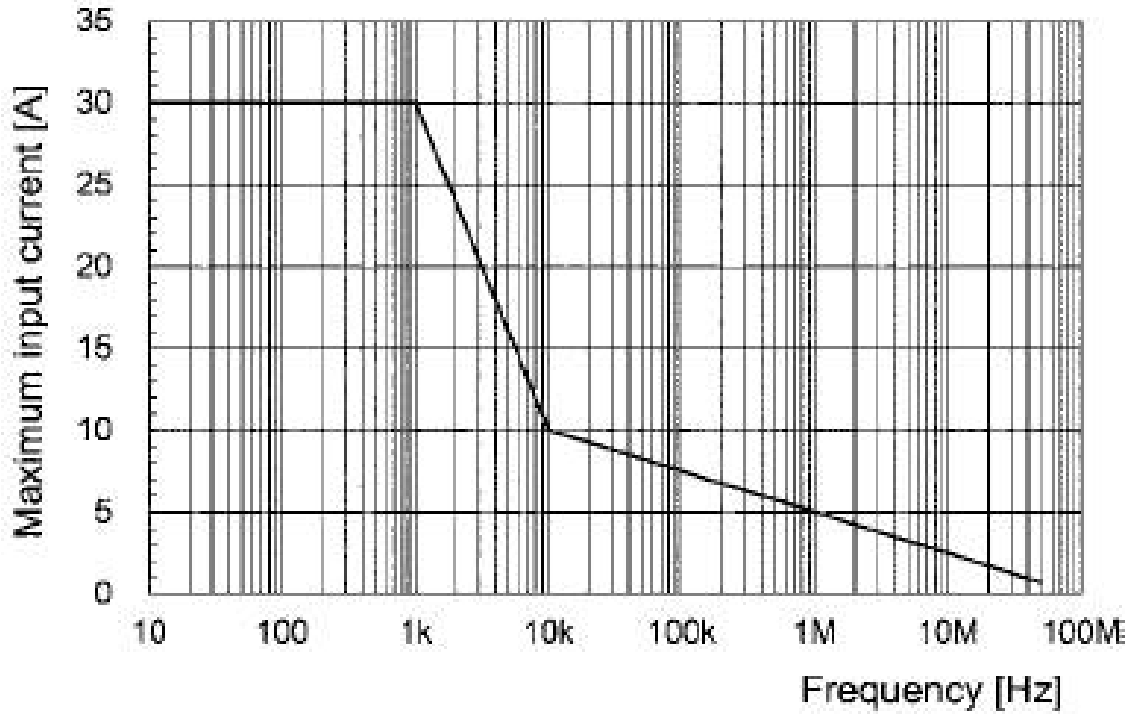

**PCA1030**

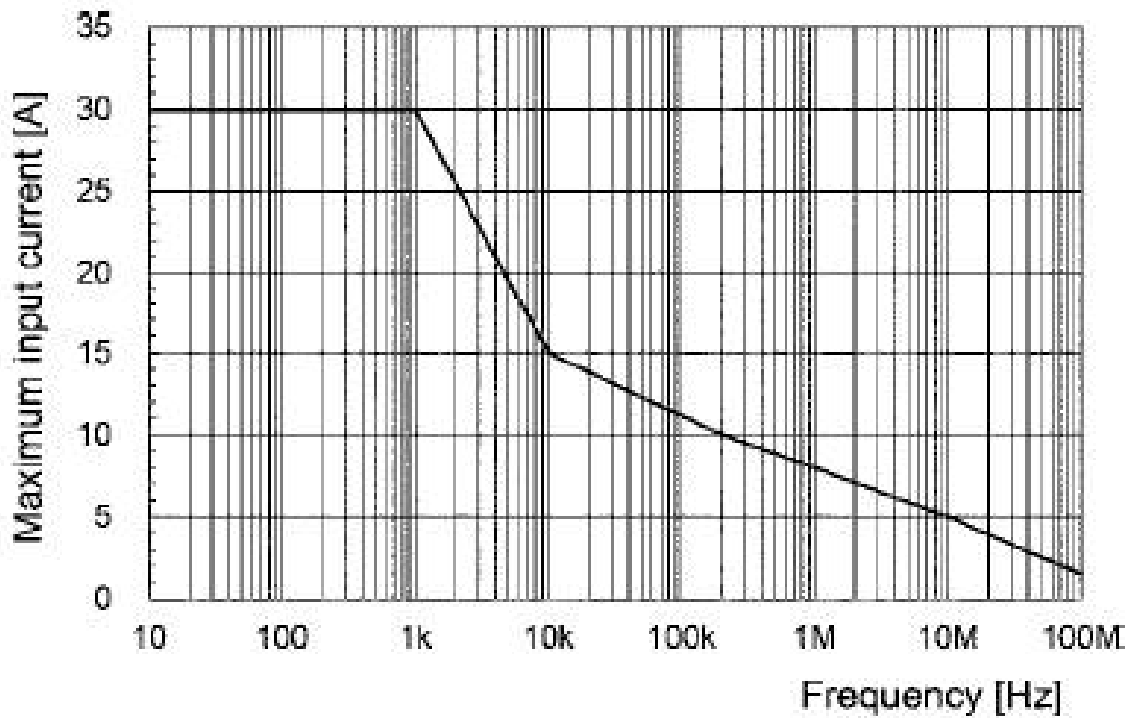

**PCA2030**

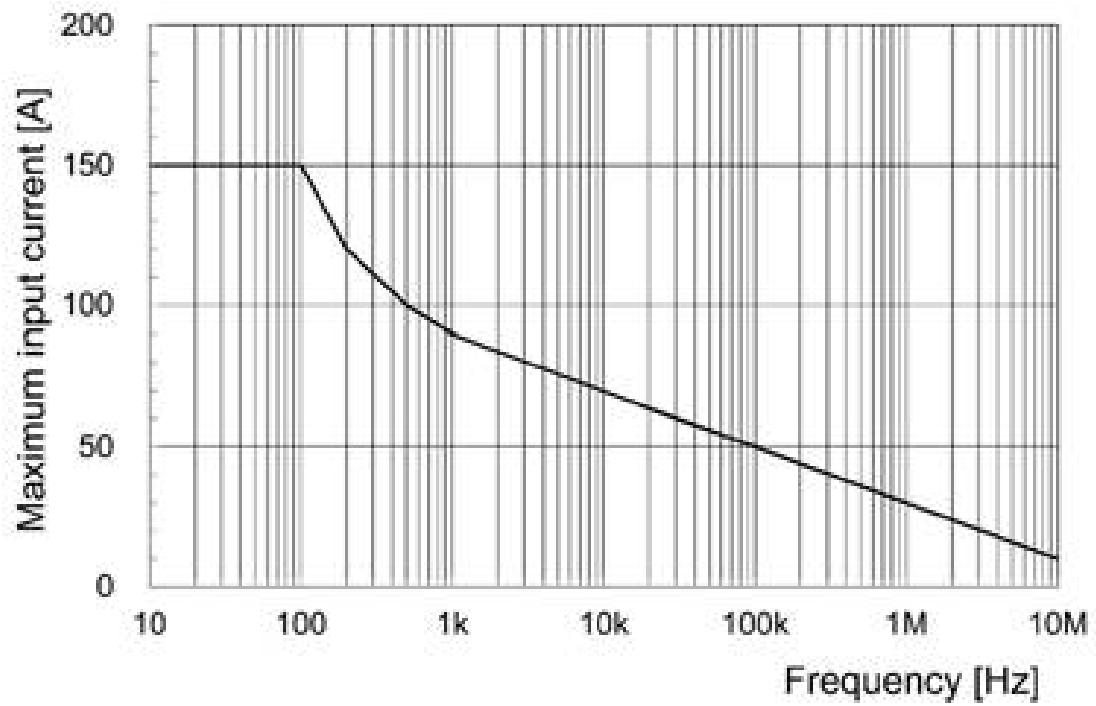
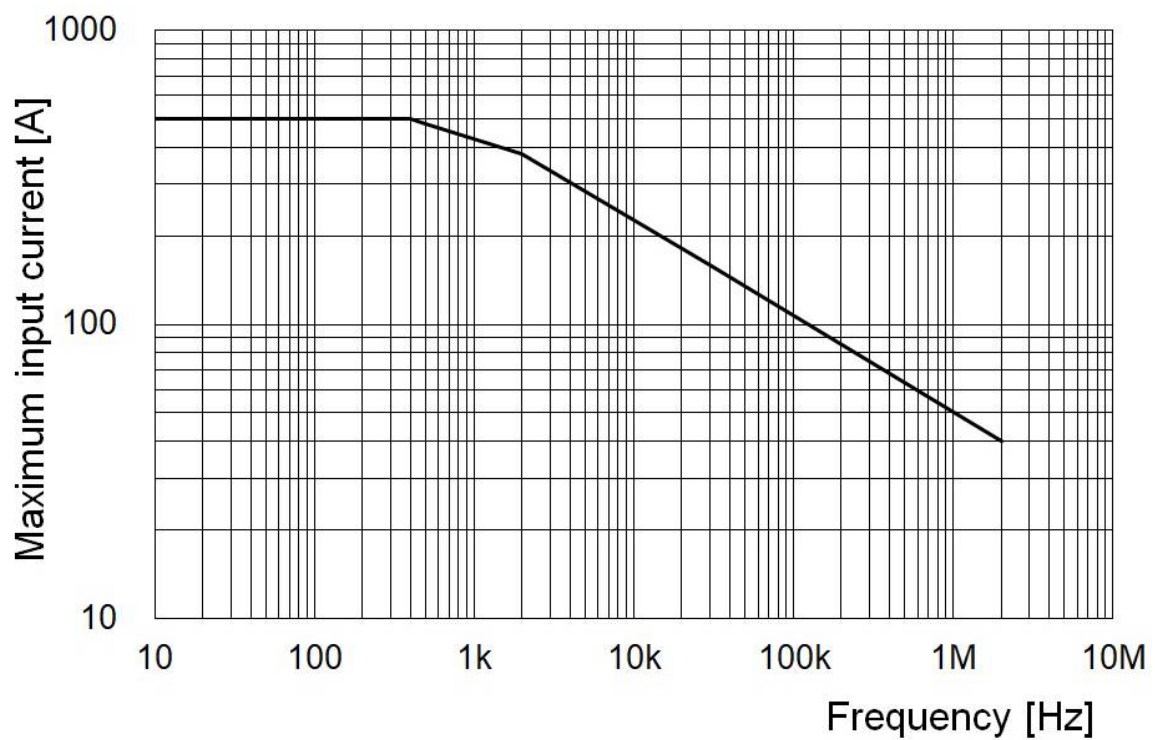
**PCA1150****PCA1500**

### Appendix 3 Input Impedance (Typical)

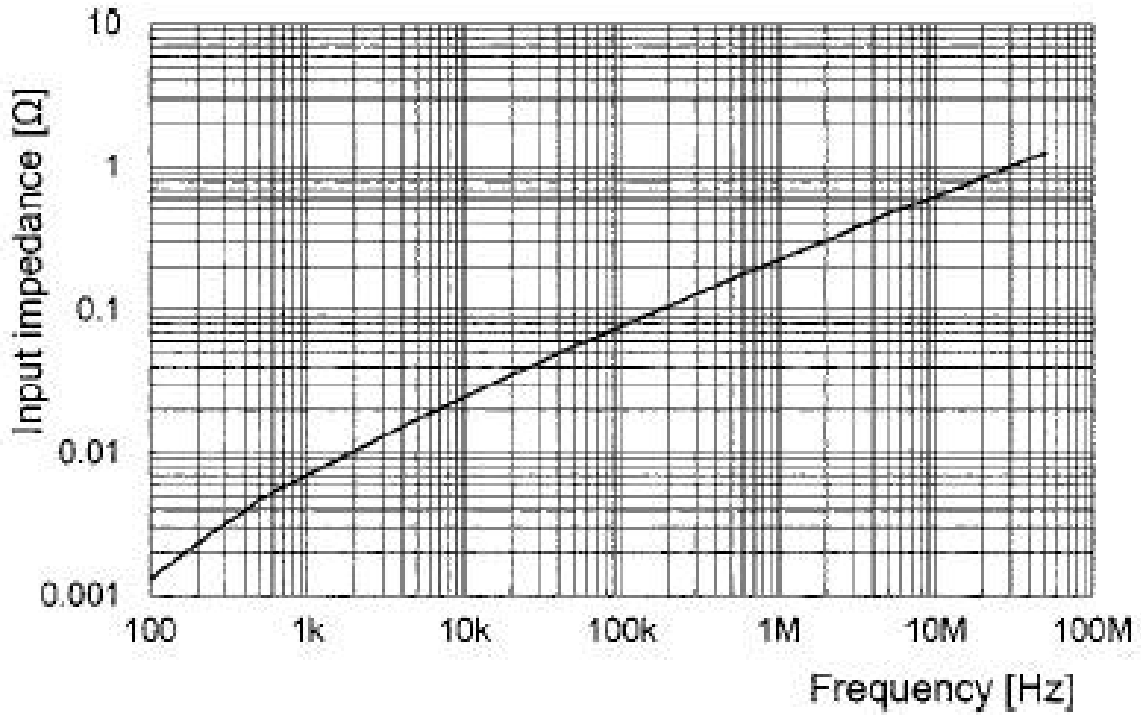

**PCA1030**

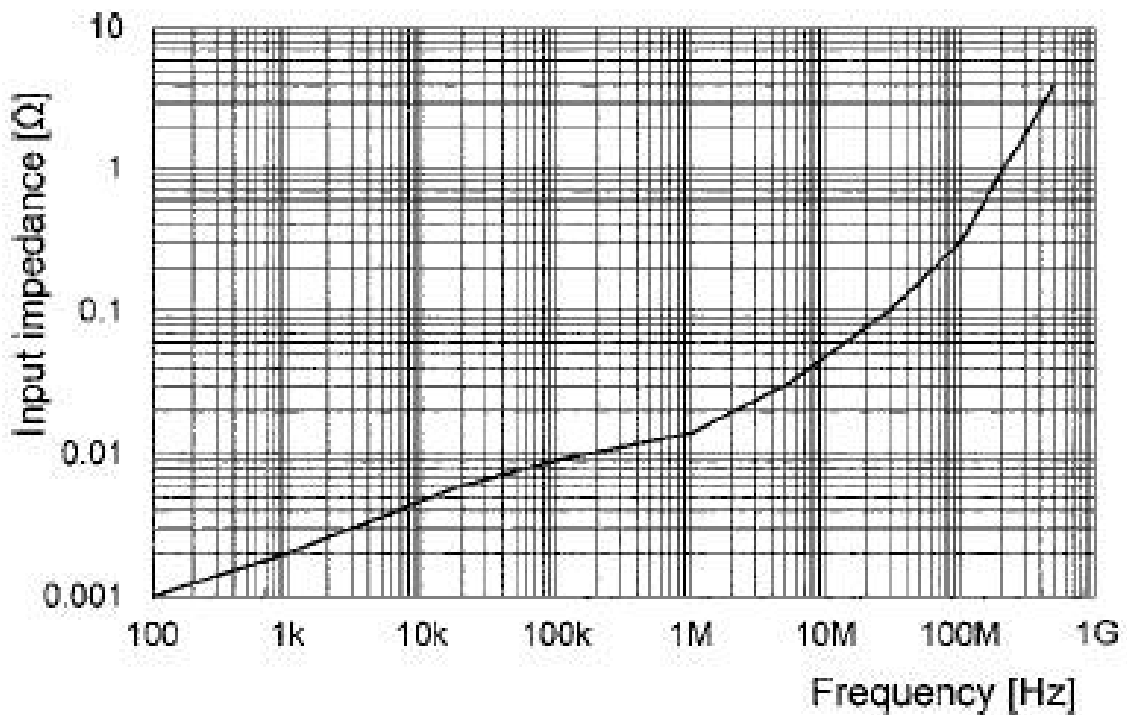

**PCA2030**

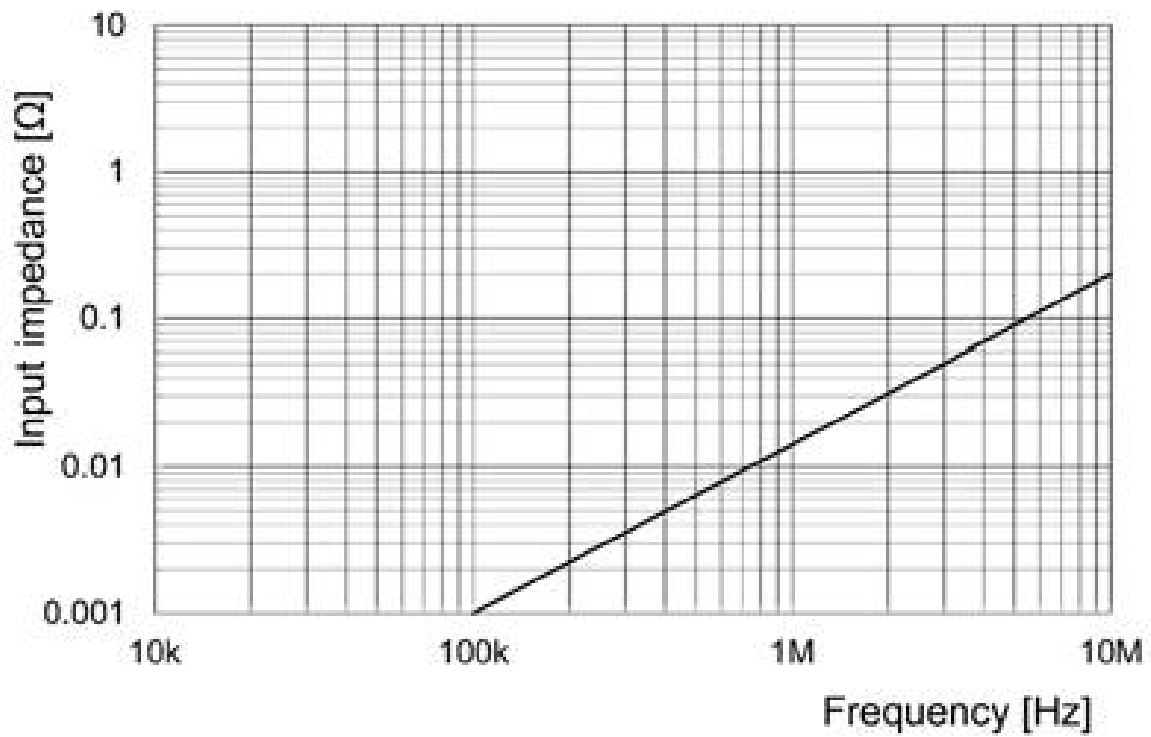
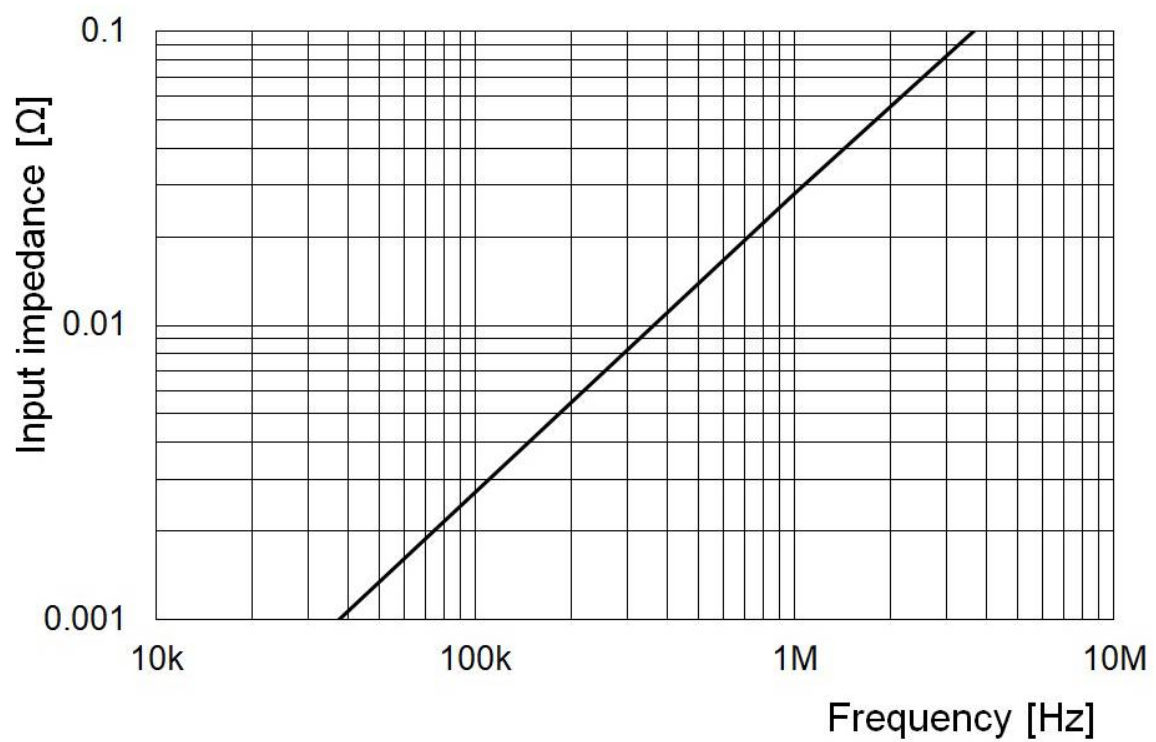

**PCA1150****PCA1500**