



### PAC SERIES

The PAC clamps are professional current clamps capable of measuring alternating and direct currents. The two jaw shapes proposed enable users to clamp cables or small busbars.

Making use of the Hall effect principle, the models in the PAC 10 Series measure up to 400 A AC and 600 A DC, while those in the PAC 20 Series measure up to 1000 A AC and 1400 A DC.

Powered by a battery or a standard external power supply (option) via their micro-USB connector, the PAC clamps are all equipped with a Zero DC reset function and a deactivatable Auto Power Off (APO) function.

The PAC 15 and PAC 25 models are a unique range whose 1 mV/A sensitivity allows "direct" readings on the associated multimeter.

The PAC 16 and PAC 26 models offer a second 10 mV/A calibre which is more sensitive.

The PAC 17 and PAC 27 models, also called "isolated current probes", offer two calibres and are equipped with a coaxial lead and isolated BNC connections for direct connection to an oscilloscope, allowing users to view the waveform and amplitude of the current.

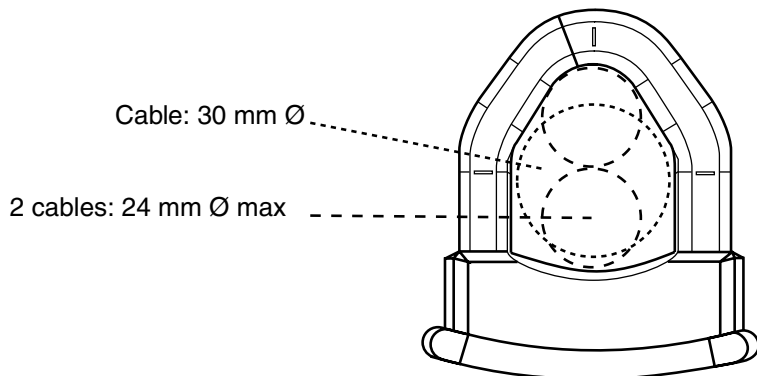

Jaws  
PAC15, 16 and 17

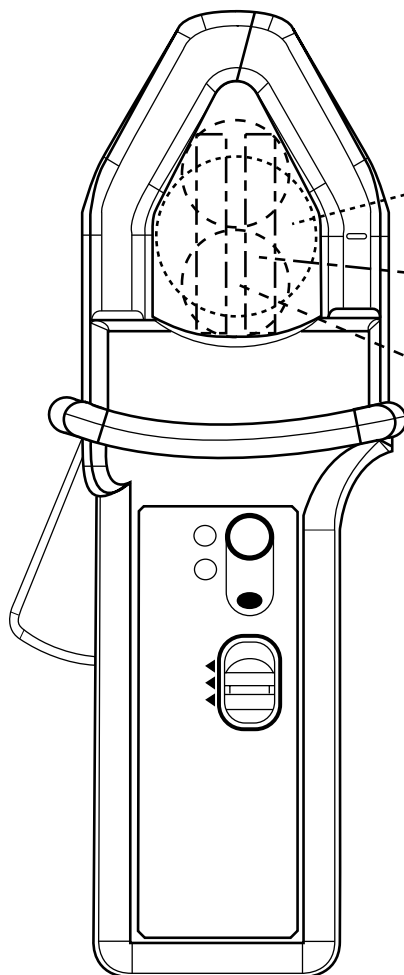

PAC 25, 26 and 27

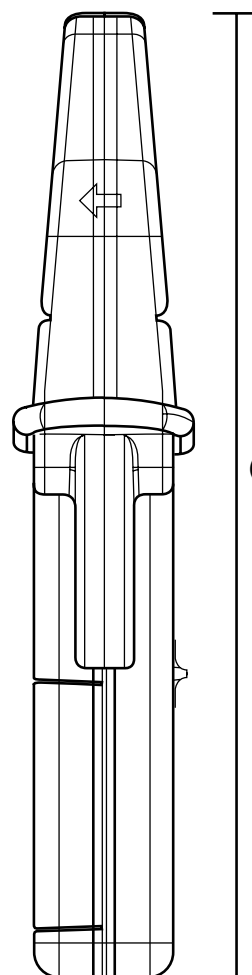
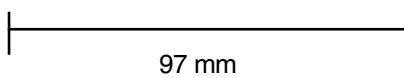

224 mm  
(PAC 15, 16 and 17)

236,5 mm  
(PAC 25, 26 and 27)

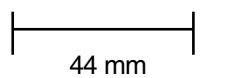

# AC/DC current clamp

## PAC15 model

PAC Series

Current	400 A AC 600 A DC
Output	1 mV/A

### DESCRIPTION

The PAC15 model accurately measures AC or DC currents by making use of the Hall effect principle. This clamp with mV output is equipped with an automatic DC zero system and a deactivatable Auto Power Off (APO) function. It can be powered by a standard mains power pack via a Micro USB connector.

### ELECTRICAL SPECIFICATIONS

- Current calibre:**  
0.5 A AC .. 400 A AC (600 A peak) / 0.5 A DC .. 600 A DC
- Output signal:**  
1 mV AC+DC / A AC+DC (0.6 V for 600 A)
- Accuracy and phase shift <sup>(1)</sup>:**

Primary current	0.5 A .. 3 A	3 A .. 100 A	100 A .. 300 A	300 A .. 400 A	400 A .. 500 A (DC only)	500 A .. 600 A (DC only)
Accuracy in % of output signal	≤ 1.5 % + 1 mV	≤ 1.5 % + 1 mV	≤ 2 %	≤ 2 %	≤ 3 %	≤ 4 %
Phase shift <sup>(2)</sup>	Not specified	≤ 2.2°	≤ 2.2°	≤ 1.5°	-	-

- Bandwidth:**  
DC .. 30 kHz (-3 dB) (depending on current value)
- Insertion impedance:**  
0.01 mΩ @ 400 Hz, 0.12 mΩ @ 1 kHz
- Maximum currents:**  
3,000 A DC or 1,000 A AC permanent for a frequency < 1 kHz (limitation proportional to the reciprocal of one third of the frequency beyond that)
- DC zero adjustment:**  
Automatic, by 40 - 60 mA increments
- AC noise output:**  
≤ 1 mV peak-peak
- Power supply:**  
9 V alkaline battery (NEDA 1604A, IEC 6LR61)  
5 V DC Micro USB type B
- Battery life:**  
50 hours typical
- Consumption:**  
10 mA typical (battery)  
31 mA typical (µUSB 5 V)
- "ON" LED:**  
"Lit" = In operation & battery level OK  
"Flashing" = remaining battery life < 4 hours  
"Colour = green" = APO ON  
"Colour = yellow" = APO OFF
- "OL" LED:**  
Overload indication: current measured too high for the calibre used
- Influence of power supply voltage:**  
None
- Influence of temperature:**  
≤ 3 % variation over the whole operating temperature range
- Influence of relative humidity:**  
≤ 0.5% from 10 % to 85 % RH at room temperature

- Influence of an adjacent conductor carrying a 50 Hz alternating current, 23 mm away from the clamp:**  
< 10 mA/A
- Influence of a 400 A/m external field @ 50 Hz:**  
< 1.3 A
- Influence of the position of a Ø 20 mm conductor in the jaws:**  
≤ 0.5 %
- Influence of the frequency <sup>(3)</sup>:**  
10 Hz .. 400 Hz: ≤ 1 % of Vs  
400 Hz .. 10 kHz: ≤ 3.5 % of Vs  
10 kHz .. 30 kHz: see curve
- Common mode rejection:**  
> 65 dB A/V @ 50 Hz
- Remanence:**

0 to 50 A DC:	1.2 A typical
0 to 100 A DC:	2.3 A typical
0 to 200 A DC:	3.4 A typical
0 to 400 A DC:	4.8 A typical
0 to 600 A DC:	5.5 A typical
0 to 800 A DC:	5.8 A typical

### MECHANICAL SPECIFICATIONS

- Maximum jaw opening:**  
31 mm
- Clamping capacity:**

Cables:	Ø 30 mm
	Ø 24 mm x 2
Busbars:	1 bar 50 x 10 mm
	2 bars 31.5 x 10 mm
	3 bars 25 x 8 mm
	4 bars 25 x 5 mm
- Output:**  
1.5 m double-insulated cable with male safety plugs (4 mm)



### SAFETY SPECIFICATIONS

• **Electrical:**

Type A appliance with double or reinforced insulation between the primary, the secondary and the grippable part below the guard as per IEC 61010-1 & IEC 61010-2-032  
 - 600 V category III, pollution degree 2  
 - 300 V category IV, pollution degree 2

• **Electromagnetic compatibility (EMC):**

Complies with IEC 61326-1: 2012 (portable instrument)

### CURVES

DC linearity

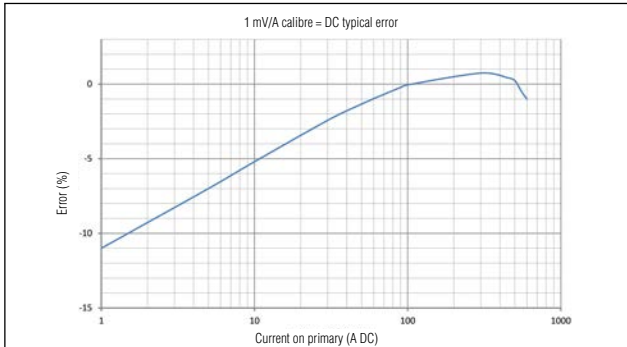

AC linearity

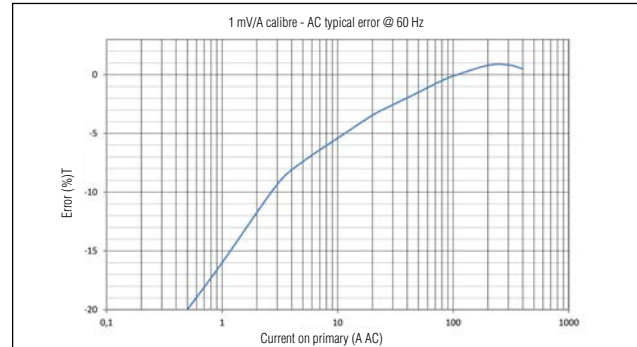

Phase shift

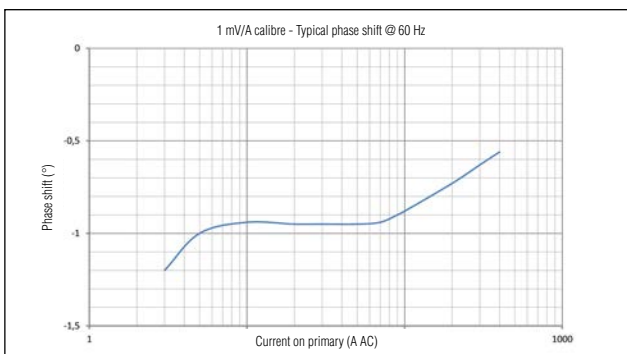

Limitation of measurable current depending on frequency

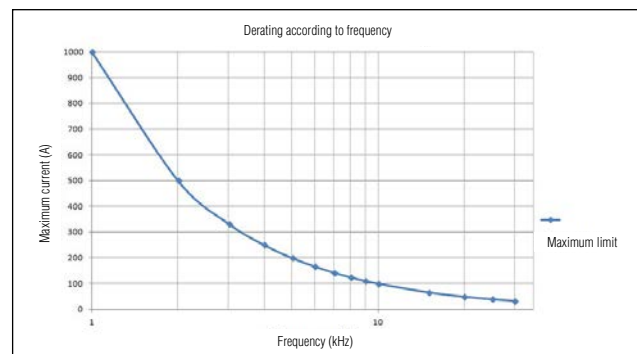

Frequency response

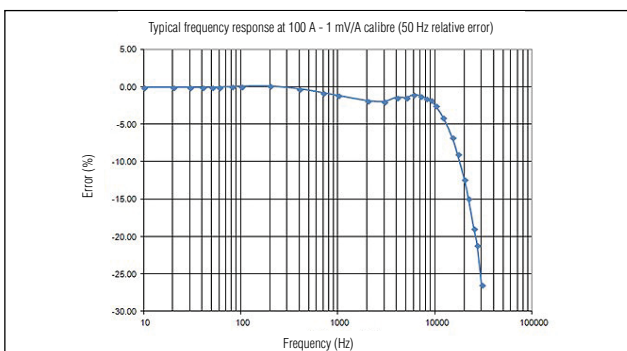

Phase shift according to frequency

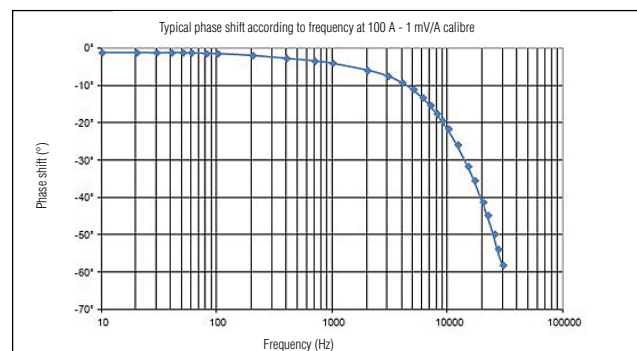

<sup>(1)</sup> Conditions of reference:  
 - Temperature & humidity: 23 °C ± 5 °K, 20 % to 75 % HR  
 - Power supply: by 6 V and 9 V battery or µUSB 5 ± 0.1 V DC,  
 - Conductor position centred on the clamp locators  
 - Magnetic field: DC earth field  
 - Absence of any external alternating magnetic fields.  
 - Absence of electric fields  
 - Measurement for a current from DC to 65 Hz sinusoidal  
 - Impedance of the measuring instrument: > 1 MΩ ≤ 100 pF.

<sup>(2)</sup> Phase shift "absolute value" (unsigned)  
<sup>(3)</sup> Outside the reference domain

<b>To order</b> PAC15 AC/DC current clamp with User's Manual and battery	<b>Reference</b> P01120115
---	-------------------------------

# AC/DC current clamp

## PAC16 model

PAC Series

<b>Current</b>	40 A AC 60 A DC	400 A AC 600 A DC
<b>Output</b>	10 mV/A	1 mV/A

### DESCRIPTION

The PAC16 model accurately measures AC or DC currents by making use of the Hall effect principle. This clamp with mV output is equipped with an automatic DC zero system and a deactivatable Auto Power Off (APO) function. It can be powered by a standard mains power pack via a Micro USB connector.

### ELECTRICAL SPECIFICATIONS

- Current calibre:**  
0.2 A AC .. 40 A AC (60 A peak) / 0.4 A DC .. 60 A DC  
0.5 A AC .. 400 A AC (600 A peak) / 0.5 A DC .. 600 A DC
- Output signal:**  
10 mV AC+DC / A AC+DC (0.6 V for 60 A)  
1 mV AC+DC / A AC+DC (0.6 V for 600 A)

- Accuracy and phase shift <sup>(1)</sup>:**

- 60 A calibre

Primary current	0.5 A .. 1 A	1 A .. 20 A	20 A .. 30 A	30 A .. 40 A	40 A .. 60 A (DC only)
Accuracy in % of output signal	≤ 3 % + 5 mV	≤ 3 % + 5 mV	≤ 3 % + 5 mV	≤ 1.5 %	≤ 1.5 %
Phase shift <sup>(2)</sup>	Not specified	≤ 3°	≤ 2.2°	≤ 2.2°	-

- 600 A calibre

Primary current	0.5 A .. 3 A	3 A .. 100 A	100 A .. 300 A	300 A .. 400 A	400 A .. 500 A (DC only)	500 A .. 600 A (DC only)
Accuracy in % of output signal	≤ 1.5 % + 1 mV	≤ 1.5 % + 1 mV	≤ 2 %	≤ 2 %	≤ 3 %	≤ 4 %
Phase shift <sup>(3)</sup>	Not specified	≤ 2.2°	≤ 2.2°	≤ 1.5°	-	-

- Bandwidth:**  
DC .. 30 kHz (-3 dB) (depending on current value)
- Insertion impedance:**  
0.01 mΩ @ 400 Hz, 0.12 mΩ @ 1 kHz
- Maximum currents:**  
3,000 A DC or 1,000 A AC permanent for a frequency < 1 kHz (limitation proportional to the reciprocal of one third of the frequency beyond that)
- DC zero adjustment:**  
Automatic, by 40 - 60 mA increments
- AC noise output:**
  - 60 A calibre: ≤ 3 mV or 0.3 A peak-peak
  - 600 A calibre: ≤ 1 mV or 1 A peak-peak
- Power supply:**  
9 V alkaline battery (NEDA 1604A, IEC 6LR61)  
5 V DC Micro USB type B
- Battery life:**  
50 hours typical
- Consumption:**  
10 mA typical (battery)  
31 mA typical (µUSB 5 V)
- "ON" LED:**  
"Lit" = In operation & battery level OK  
"Flashing" = remaining battery life < 4 hours  
"Colour = green" = APO ON  
"Colour = yellow" = APO OFF
- "OL" LED:**  
Overload indication: current measured too high for the calibre used

- Influence of power supply voltage:**  
None
- Influence of temperature:**  
≤ 3 % variation over the whole operating temperature range
- Influence of relative humidity:**  
≤ 0.5% from 10 % to 85 % RH at room temperature
- Influence of an adjacent conductor carrying a 50 Hz alternating current, 23 mm away from the clamp:**  
< 10 mA/A
- Influence of a 400 A/m external field @ 50 Hz:**  
< 1.3 A
- Influence of the position of a Ø 20 mm conductor in the jaws:**  
≤ 0.5 %
- Influence of the frequency <sup>(4)</sup>:**
  - 60 A calibre:  
10 Hz .. 400 Hz: ≤ 1 % of Vs  
400 Hz .. 7 kHz: ≤ 3.5 % of Vs  
7 kHz .. 30 kHz: see curve
  - 600 A calibre:  
10 Hz .. 400 Hz: ≤ 1 % of Vs  
400 Hz .. 10 kHz: ≤ 3.5 % of Vs  
10 kHz .. 30 kHz: see curve
- Common mode rejection:**  
> 65 dB A/V @ 50 Hz

- Remanence:**

0 to 50 A DC:	1.2 A typical
0 to 100 A DC:	2.3 A typical
0 to 200 A DC:	3.4 A typical
0 to 400 A DC:	4.8 A typical
0 to 600 A DC:	5.5 A typical
0 to 800 A DC:	5.8 A typical

### MECHANICAL SPECIFICATIONS

- Maximum jaw opening:**  
31 mm
- Clamping capacity:**  
Cables: Ø 30 mm  
Ø 24 mm x 2  
Busbars: 1 bar 50 x 10 mm  
2 bars 31.5 x 10 mm  
3 bars 25 x 8 mm  
4 bars 25 x 5 mm
- Output:**  
1.5 m double-insulated cable with male safety plugs (4 mm)
- Dimensions:**  
224 x 97 x 44 mm
- Weight:**  
440 g with battery
- Operating temperature:**  
-10 °C to +55 °C
- Storage temperature:**  
-40 °C to +80 °C



# AC/DC current clamp

## PAC16 model

PAC Series

- **Max. temperature of clamped conductor (measured):**  
+90 °C (may spike at +110 °C)
- **Max temperature of jaws:**  
+80 °C
- **Relative humidity for operation:**  
0 to 85 % RH with a linear decrease above 35 °C
- **Operating altitude:**  
0 to 2,000 m

- **Enclosure ingress protection:**  
IP 40 (IEC 60529)
- **Fall height:**  
1 m (IEC 60068-2-32)
- **Self-extinguishing capability**  
UL94 V1
- **Colours:**  
Casing: dark grey  
Jaws: red

### SAFETY SPECIFICATIONS

- **Electrical:**  
Type A appliance with double or reinforced insulation between the primary, the secondary and the grippable part below the guard as per IEC 61010-1 & IEC 61010-2-032  
- 600 V category III, pollution degree 2  
- 300 V category IV, pollution degree 2
- **Electromagnetic compatibility (EMC):**  
Complies with IEC 61326-1: 2012 (portable instrument)

### CURVES

60 A calibre

600 A calibre

#### DC linearity

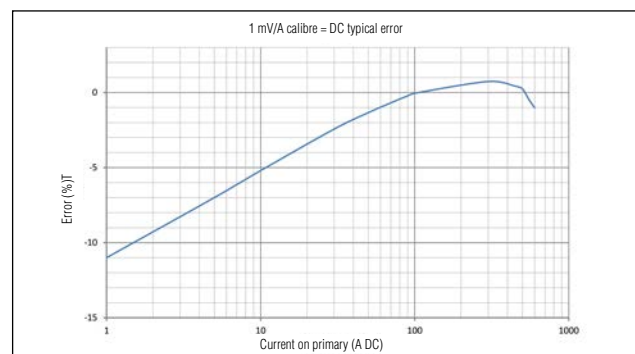
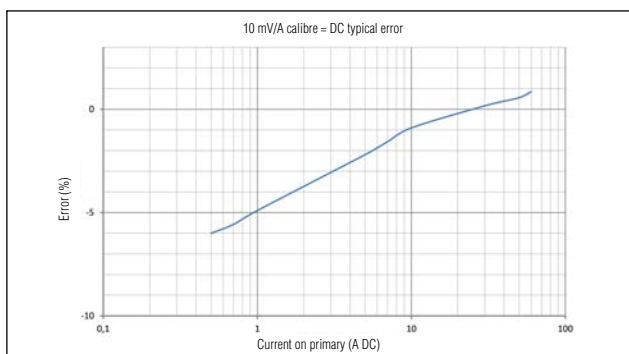

#### AC linearity

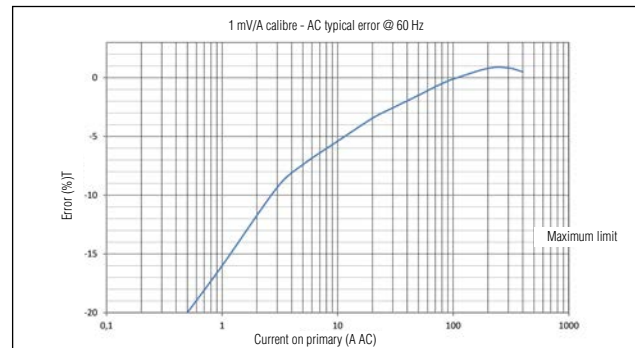
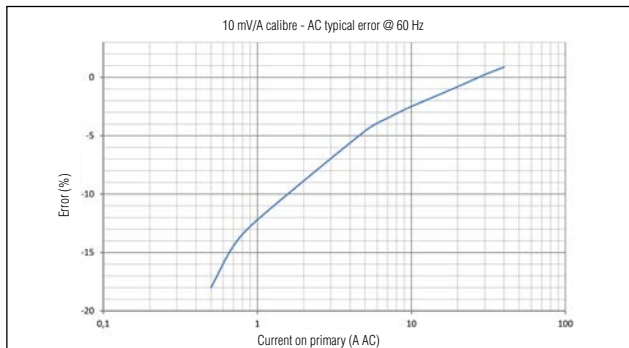

#### Phase shift

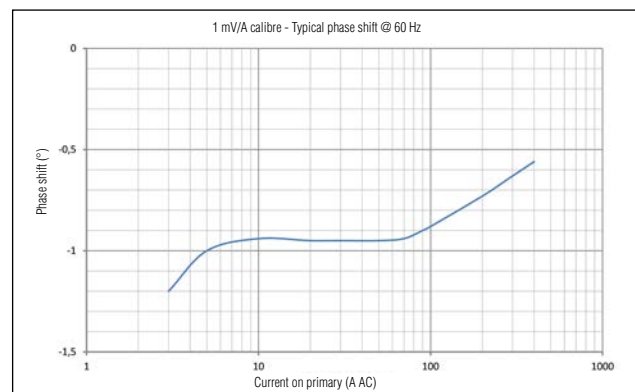
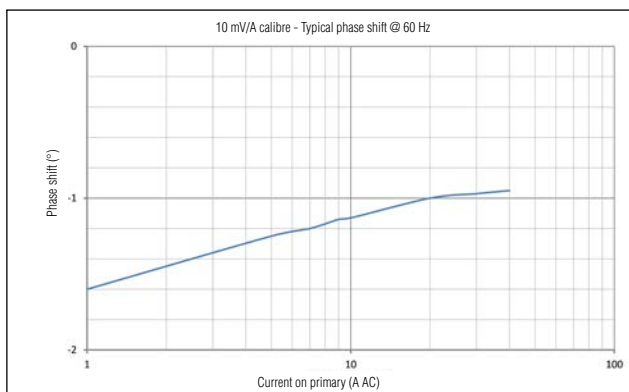

### CURVES

Limitation of measurable current depending on frequency

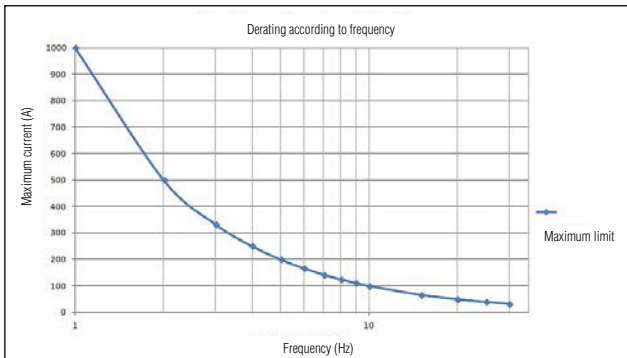

60 A calibre



600 A calibre

Frequency response

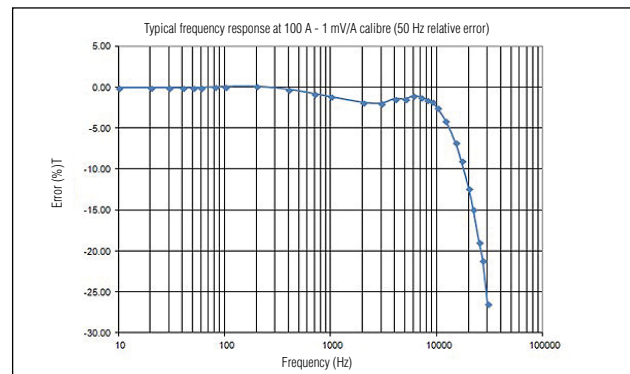
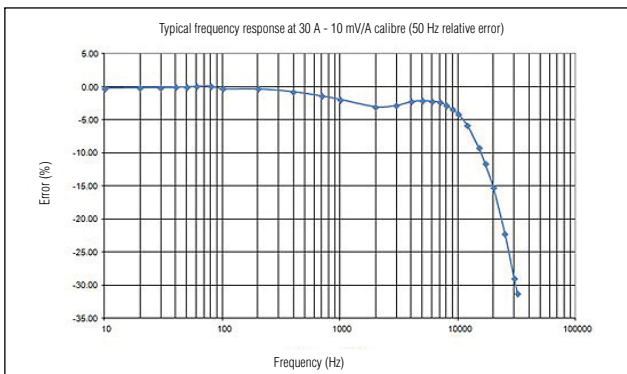

Phase shift according to frequency

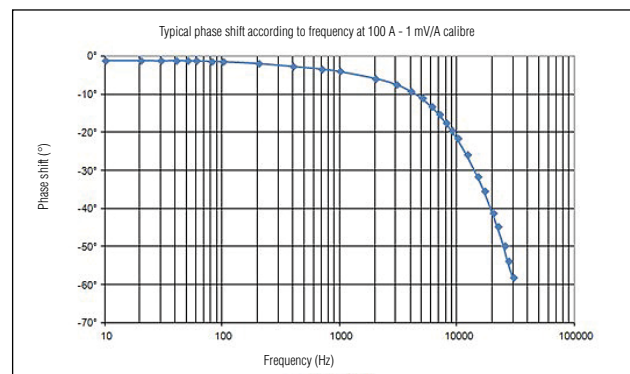
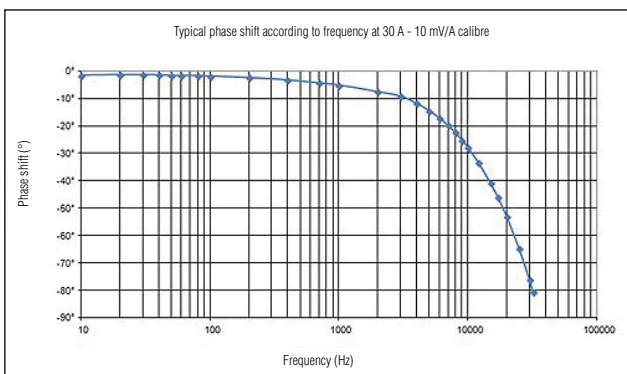

- (1) Conditions of reference:
- Temperature & humidity: 23 °C ± 5 °K, 20 % to 75 % HR
  - Power supply: by 6 V and 9 V battery or µUSB 5 ± 0.1 V DC,
  - Conductor position centred on the clamp locators
  - Magnetic field: DC earth field
  - Absence of any external alternating magnetic fields.
  - Absence of electric fields
  - Measurement for a current from DC to 65 Hz sinusoidal
  - Impedance of the measuring instrument: > 1 MΩ ≤ 100 pF.

(2) Phase shift "absolute value" (unsigned)

(3) Outside the reference domain

To order	Reference
PAC16 AC/DC current clamp with User's Manual and battery	P01120116

## PAC17 model (Isolated AC/DC current sensor)

<b>Current</b>	40 A AC 60 A DC	400 A AC 600 A DC
<b>Output</b>	10 mV/A	1 mV/A

### DESCRIPTION

The PAC17 model accurately measures AC or DC currents by making use of the Hall effect principle. This clamp with mV output on BNC (direct reading on oscilloscopes, etc.) is equipped with an automatic DC zero system and a deactivatable Auto Power Off (APO) function. It can be powered by a standard mains power pack via a Micro USB.

### ELECTRICAL SPECIFICATIONS

- Current calibre:**  
0.2 A AC .. 40 A AC (60 A peak) / 0.4 A DC .. 60 A DC  
0.5 A AC .. 400 A AC (600 A peak) / 0.5 A DC .. 600 A DC
- Output signal:**  
10 mV AC+DC / A AC+DC (0.6 V for 60 A)  
1 mV AC+DC / A AC+DC (0.6 V for 600 A)
- Accuracy and phase shift <sup>(1)</sup>:**

#### ■ 60 A calibre

Primary current	0.5 A .. 1 A	1 A .. 20 A	20 A .. 30 A	30 A .. 40 A	40 A .. 60 A (DC only)
Accuracy in % of output signal	≤ 3 % + 5 mV	≤ 3 % + 5 mV	≤ 3 % + 5 mV	≤ 1.5 %	≤ 1.5 %
Phase shift <sup>(2)</sup>	Not specified	≤ 3°	≤ 2.2°	≤ 2.2°	-

#### ■ 600 A calibre

Primary current	0.5 A .. 3 A	3 A .. 100 A	100 A .. 300 A	300 A .. 400 A	400 A .. 500 A (DC only)	500 A .. 600 A (DC only)
Accuracy in % of output signal	≤ 1.5 % + 1 mV	≤ 1.5 % + 1 mV	≤ 2 %	≤ 2 %	≤ 3 %	≤ 4 %
Phase shift <sup>(3)</sup>	Not specified	≤ 2.2°	≤ 2.2°	≤ 1.5°	-	-

- Bandwidth:**  
DC .. 30 kHz (-3 dB) (depending on current value)
- Rise time (10 to 90 % of Vs)**  
≤ 11 μs
- Fall time (90 to 10 % of Vs)**  
≤ 11 μs
- 10 % delay time:**  
≤ 10 μs
- Insertion impedance:**  
0.01 mΩ @ 400 Hz, 2.8 mΩ @ 10 kHz
- Maximum currents:**  
3,000 A DC or 1,000 A AC permanent for a frequency < 1 kHz (limitation proportional to the reciprocal of one third of the frequency beyond that)
- DC zero adjustment:**
  - 60 A calibre & 600 A:  
Automatic, by 40 - 60 mA increments
- AC noise output:**
  - 60 A calibre: ≤ 3 mV or 0.3 A peak-peak
  - 600 A calibre: ≤ 1 mV or 1 A peak-peak
- Power supply:**  
9 V alkaline battery (NEDA 1604A, IEC 6LR61)  
5 V DC Micro USB type B
- Battery life:**  
50 hours typical
- Consumption:**  
10 mA typical (battery)  
31 mA typical (μUSB 5 V)

- "ON" LED:**  
"Lit" = In operation & battery level OK  
"Flashing" = remaining battery life < 4 hours  
"Colour = green" = APO ON  
"Colour = yellow" = APO OFF
- "OL" LED:**  
Overload indication: current measured too high for the calibre used
- Influence of power supply voltage:**  
None
- Influence of temperature:**  
≤ 3 % variation over the whole operating temperature range
- Influence of relative humidity:**  
≤ 0.5% from 10 % to 85 % RH at room temperature
- Influence of an adjacent conductor carrying a 50 Hz alternating current, 23 mm away from the clamp:**  
< 10 mA/A
- Influence of a 400 A/m external field @ 50 Hz:**  
< 1.3 A
- Influence of the position of a Ø 20 mm conductor in the jaws:**  
≤ 0.5 %
- Influence of the frequency <sup>(4)</sup>:**
  - 60 A calibre:  
10 Hz .. 400 Hz: ≤ 1 % of Vs  
400 Hz .. 7 kHz: ≤ 3.5 % of Vs  
7 kHz .. 30 kHz: see curve

- 600 A calibre:  
10 Hz .. 400 Hz: ≤ 1 % of Vs  
400 Hz .. 10 kHz: ≤ 3.5 % of Vs  
10 kHz .. 30 kHz: see curve
- Common mode rejection:**  
> 65 dB A/V @ 50 Hz
- Remanence:**
  - 0 to 50 A DC: 1.2 A typical
  - 0 to 100 A DC: 2.3 A typical
  - 0 to 200 A DC: 3.4 A typical
  - 0 to 400 A DC: 4.8 A typical
  - 0 to 600 A DC: 5.5 A typical
  - 0 to 800 A DC: 5.8 A typical

### MECHANICAL SPECIFICATIONS

- Maximum jaw opening:**  
31 mm
- Clamping capacity:**  
Cables: Ø 30 mm  
Ø 24 mm x 2  
Busbars: 1 bar 50 x 10 mm  
2 bars 31.5 x 10 mm  
3 bars 25 x 8 mm  
4 bars 25 x 5 mm
- Output:**  
2 m coaxial cable terminated by an isolated BNC plug
- Dimensions:**  
224 x 97 x 44 mm
- Weight:**  
440 g with battery





## PAC17 model (Isolated AC/DC current sensor)

- **Operating temperature:**  
-10 °C to +55 °C
- **Storage temperature:**  
-40 °C to +80 °C
- **Max. temperature of clamped conductor (measured):**  
+90 °C (may spike at +110 °C)
- **Max temperature of jaws:**  
+80 °C
- **Relative humidity for operation:**  
0 to 85 % RH with a linear decrease above 35 °C
- **Operating altitude:**  
0 to 2,000 m
- **Enclosure ingress protection:**  
IP 40 (IEC 60529)
- **Fall height:**  
1 m (IEC 60068-2-32)
- **Self-extinguishing capability**  
UL94 V1
- **Colours:**  
Casing: dark grey  
Jaws: red

### SAFETY SPECIFICATIONS

- **Electrical:**  
Type A appliance with double or reinforced insulation between the primary, the secondary and the grippable part below the guard as per IEC 61010-1 & IEC 61010-2-032  
- 600 V category III, pollution degree 2  
- 300 V category IV, pollution degree 2
- **Electromagnetic compatibility (EMC):**  
Complies with IEC 61326-1: 2012 (portable instrument)

### CURVES

60 A calibre

600 A calibre

#### DC linearity

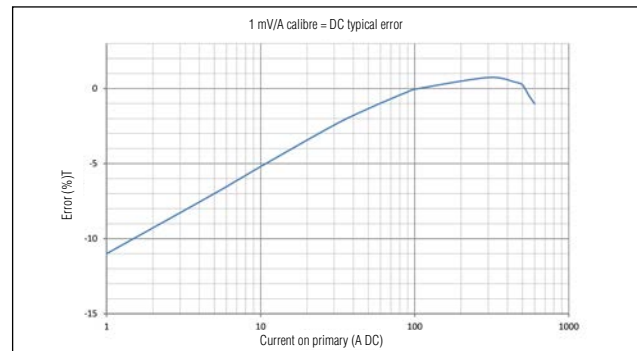
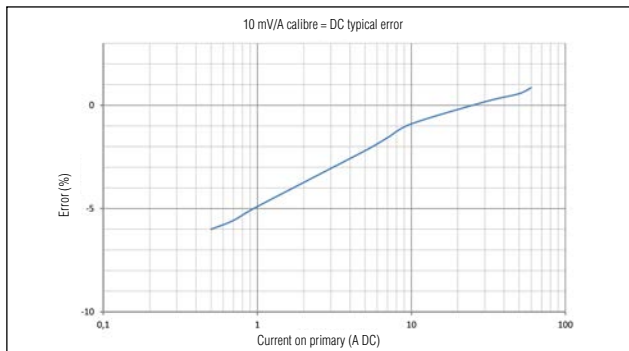

#### AC linearity

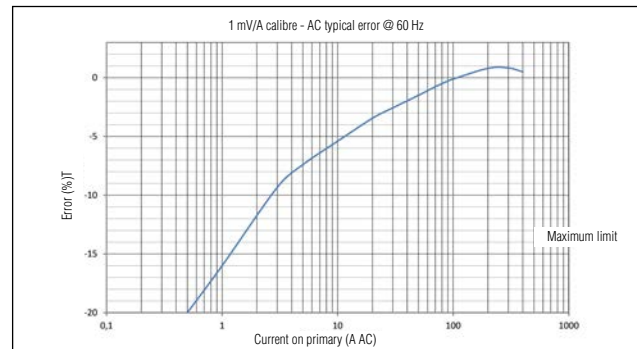
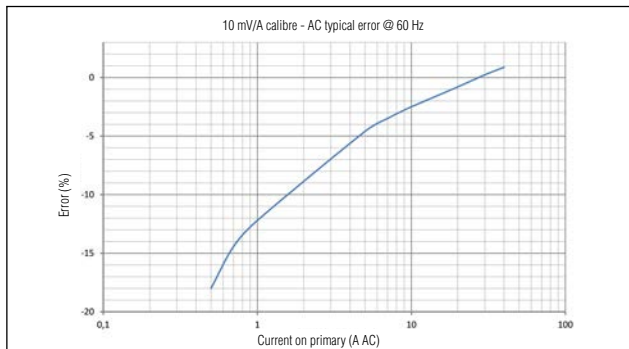

#### Phase shift

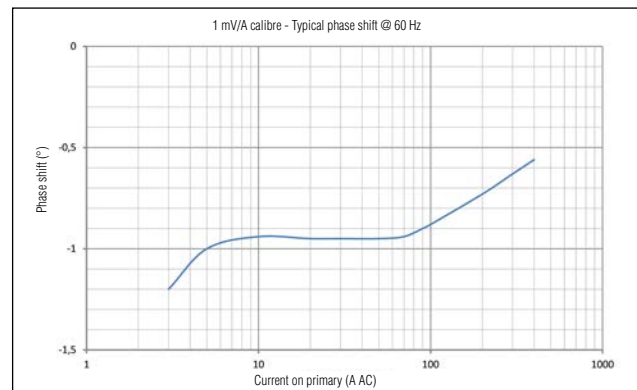
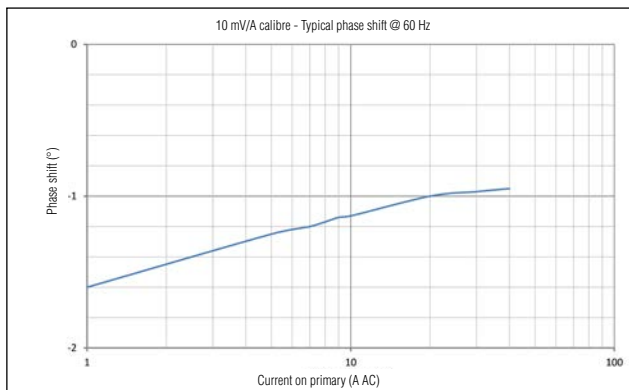

### CURVES

Limitation of measurable current depending on frequency

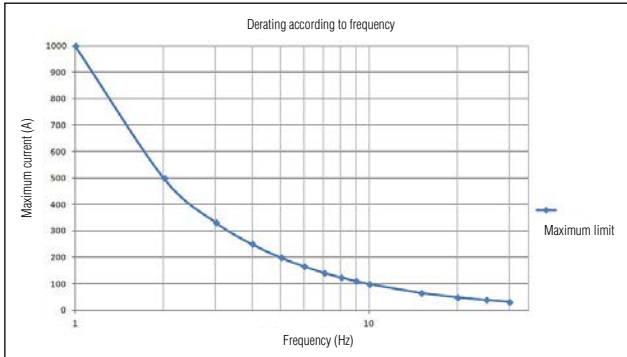

60 A calibre

600 A calibre

Frequency response

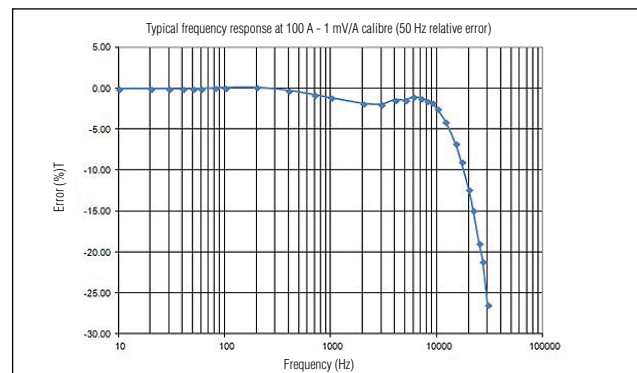
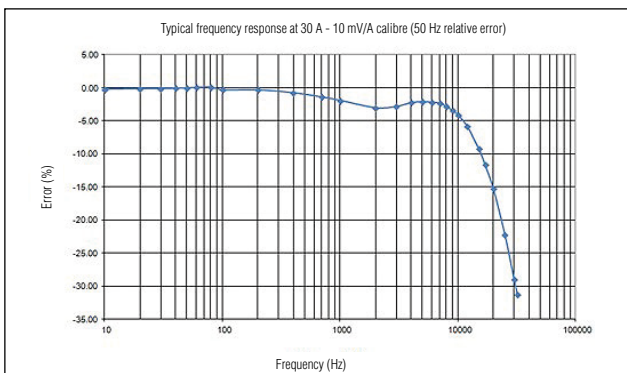

Phase shift according to frequency

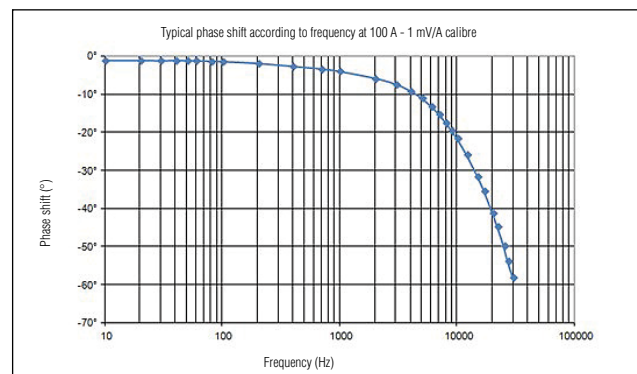
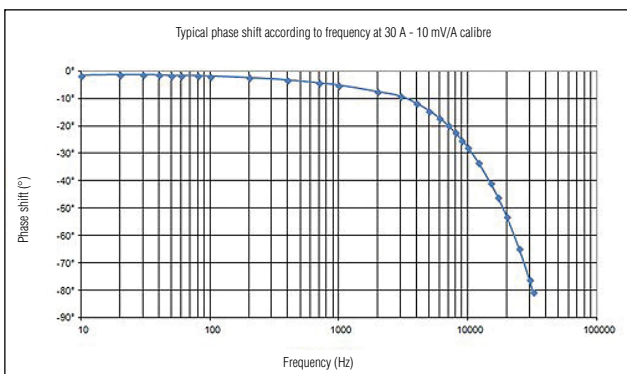

### CURVES

Pulse response

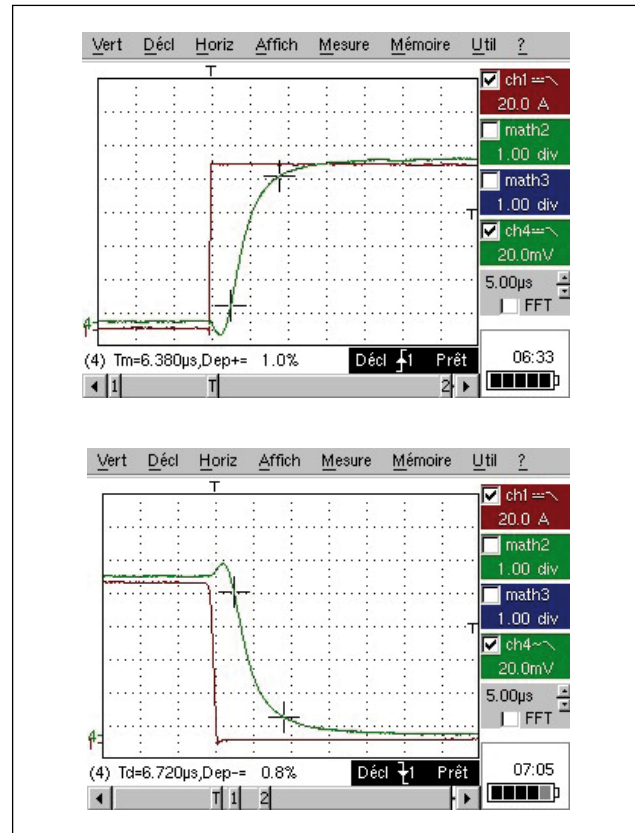
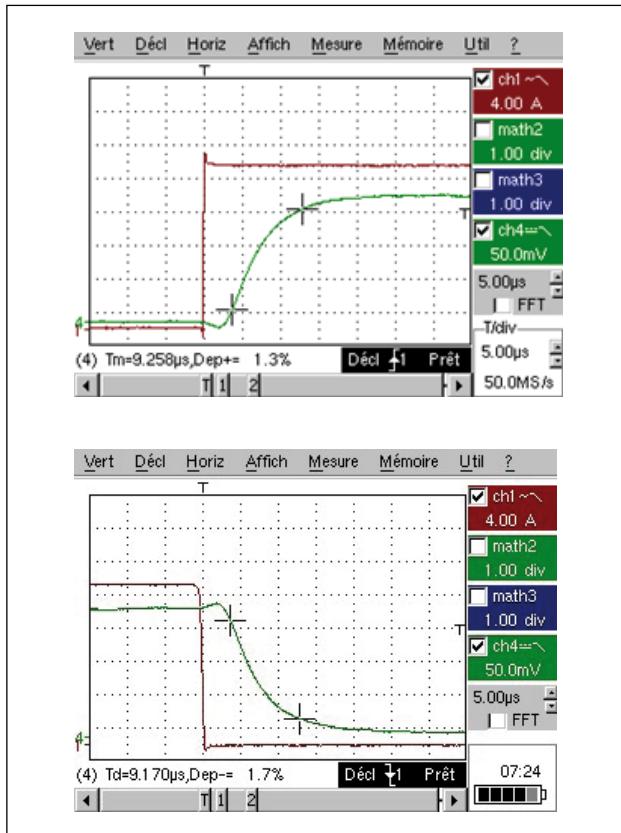

- <sup>(1)</sup> Conditions of reference:
- Temperature & humidity: 23 °C ± 5 °K, 20 % to 75 % HR
  - Power supply: by 6 V and 9 V battery or  $\mu$ USB 5 ± 0.1 V DC,
  - Conductor position centred on the clamp locators
  - Magnetic field: DC earth field
  - Absence of any external alternating magnetic fields.
  - Absence of electric fields
  - Measurement for a current from DC to 65 Hz sinusoidal
  - Impedance of the measuring instrument: > 1 M $\Omega$  ≤ 100 pF.
- <sup>(2)(3)</sup> Phase shift "absolute value" (unsigned)
- <sup>(4)</sup> Outside the reference domain

To order	Reference
<b>PAC17</b> AC/DC current clamp for oscilloscope with User's Manual and battery	P01120117

# AC/DC current clamp

## PAC25 model

PAC Series

Current	1,000 A AC 1,400 A DC
Output	1 mV/A

### DESCRIPTION

The PAC25 model accurately measures AC or DC currents by making use of the Hall effect principle. This clamp with mV output is equipped with an automatic DC zero system and a deactivatable Auto Power Off (APO) function. It can be powered by a standard mains power pack via a Micro USB connector.

### ELECTRICAL SPECIFICATIONS

- Current calibre:**  
0.5 A AC .. 1,000 A AC (1,400 A peak) / 0.5 A DC .. 1,400 A DC
- Output signal:**  
1 mV AC+DC / A AC+DC (1.4 V for 1,400 A)
- Accuracy and phase shift <sup>(1)</sup>:**

Primary current	0.5 A .. 3 A	3 A .. 100 A	100 A .. 200 A	200 A .. 800 A	800 A .. 1,000 A	1,000 A .. 1,400 A (DC only)
Accuracy in % of output signal	≤ 1.5 % + 1 mV	≤ 1.5 % + 1 mV	≤ 2.5 %	≤ 2.5 %	≤ 4 %	≤ 5 %
Phase shift <sup>(2)</sup>	Not specified	≤ 2°	≤ 2°	≤ 1.5°	≤ 1.5°	-

- Bandwidth:**  
DC .. 30 kHz (-3 dB) (depending on current value)
- Insertion impedance:**  
0.05 mΩ @ 400 Hz, 0.14 mΩ @ 1 kHz
- Maximum currents:**  
3,000 A DC or 1,000 A AC permanent for a frequency < 1 kHz (limitation proportional to the reciprocal of one third of the frequency beyond that)
- DC zero adjustment:**  
Automatic, by 40 - 60 mA increments
- AC noise output:**  
≤ 1 mV peak-peak
- Power supply:**  
9 V alkaline battery (NEDA 1604A, IEC 6LR61)  
5 V DC Micro USB type B
- Battery life:**  
50 hours typical
- Consumption:**  
10 mA typical (battery)  
31 mA typical (µUSB 5 V)
- "ON" LED:**  
"Lit" = In operation & battery level OK  
"Flashing" = remaining battery life < 4 hours  
"Colour = green" = APO ON  
"Colour = yellow" = APO OFF
- "OL" LED:**  
Overload indication: current measured too high for the calibre used
- Influence of power supply voltage:**  
None
- Influence of temperature:**  
≤ 3 % variation over the whole operating temperature range
- Influence of relative humidity:**  
≤ 0.5 % from 10 % to 85 % RH at room temperature

- Influence of an adjacent conductor carrying a 50 Hz alternating current, 23 mm away from the clamp:**  
< 10 mA/A
- Influence of a 400 A/m external field @ 50 Hz:**  
< 1.3 A
- Influence of the position of a Ø 20 mm conductor in the jaws:**  
≤ 0.5 %
- Influence of the frequency <sup>(3)</sup>:**  
10 Hz .. 400 Hz: ≤ 1 % of Vs  
400 Hz .. 10 kHz: ≤ 3.5 % of Vs  
10 kHz .. 30 kHz: see curve
- Common mode rejection:**  
> 65 dB A/V @ 50 Hz
- Remanence:**  
0 to 100 A DC: 2.8 A typical  
0 to 200 A DC: 3.5 A typical  
0 to 400 A DC: 5 A typical  
0 to 800 A DC: 5.3 A typical  
0 to 1,200 A DC: 5.7 A typical  
0 to 1,400 A DC: 5.8 A typical

### MECHANICAL SPECIFICATIONS

- Maximum jaw opening:**  
39 mm
- Clamping capacity:**  
Cables: Ø 39 mm  
Ø 25.4 mm x 2  
Busbars: 1 bar 50 x 12.5 mm  
2 bars 50 x 5 mm or 31.5 x 10 mm  
3 bars 25 x 8 mm  
4 bars 25 x 5 mm
- Output:**  
1.5 m double-insulated cable with male safety plugs (4 mm)
- Dimensions:**  
236.5 x 97 x 44 mm



- Weight:**  
520 g with battery
- Operating temperature:**  
-10 °C to +55 °C
- Storage temperature:**  
-40 °C to +80 °C
- Max. temperature of clamped conductor (measured):**  
+90 °C (may spike at +110 °C)
- Max temperature of jaws:**  
+80 °C
- Relative humidity for operation:**  
0 to 85 % RH with a linear decrease above 35 °C
- Operating altitude:**  
0 to 2,000 m
- Enclosure ingress protection:**  
IP 40 (IEC 60529)
- Fall height:**  
1 m (IEC 60068-2-32)
- Self-extinguishing capability**  
UL94 V1
- Colours:**  
Casing: dark grey  
Jaws: red

### SAFETY SPECIFICATIONS

- Electrical:**  
Type A appliance with double or reinforced insulation between the primary, the secondary and the grippable part below the guard as per IEC 61010-1 & IEC 61010-2-032  
- 600 V category III, pollution degree 2  
- 300 V category IV, pollution degree 2
- Electromagnetic compatibility (EMC):**  
Complies with IEC 61326-1: 2012 (portable instrument)

### CURVES

DC linearity

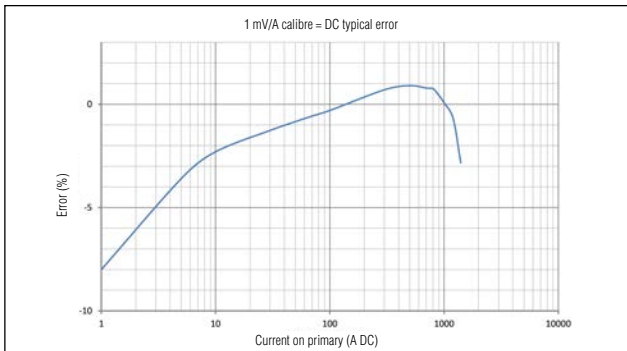

AC linearity

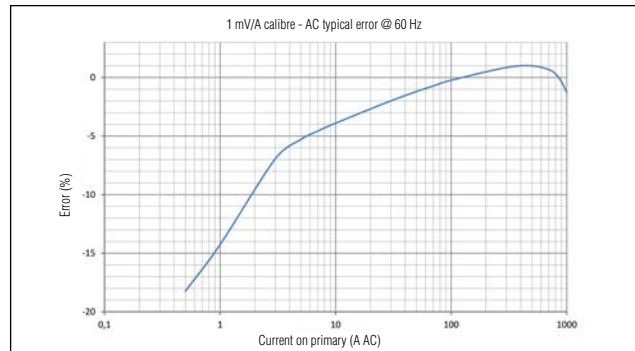

Phase shift

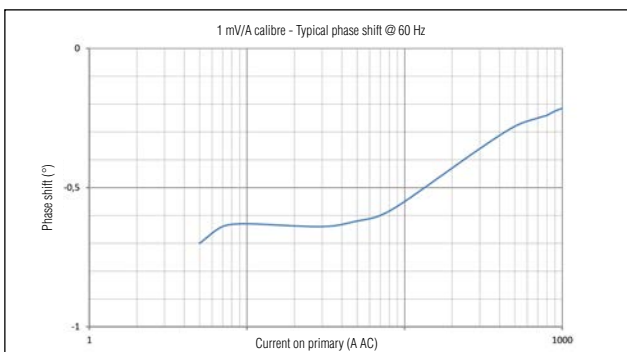

Limitation of measurable current depending on frequency

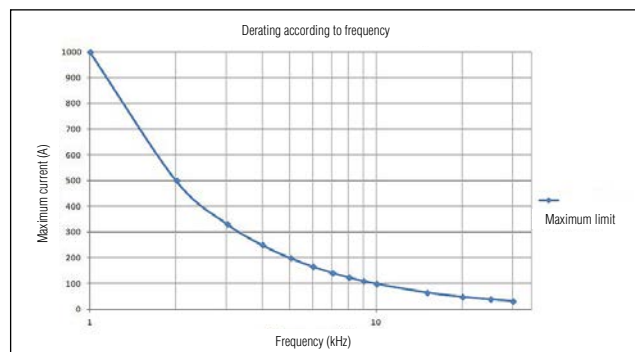

Frequency response

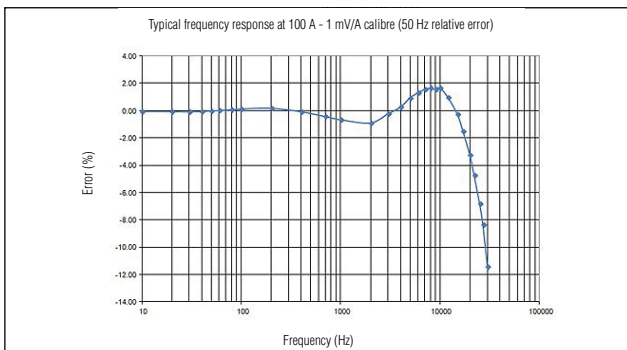

Phase shift according to frequency

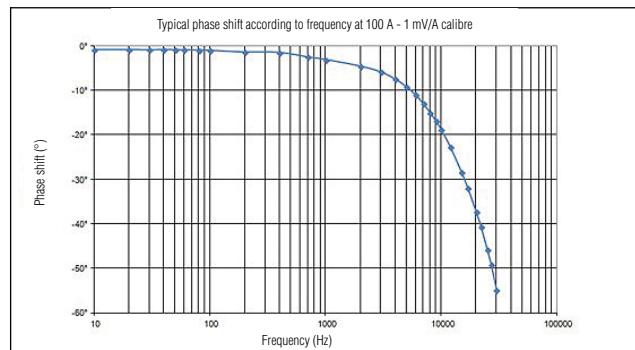

<sup>(1)</sup> Conditions of reference:

- Temperature & humidity: 23 °C ± 5 °K, 20 % to 75 % HR
- Power supply: by 6 V and 9 V battery or µUSB 5 ± 0.1 V DC,
- Conductor position centred on the clamp locators
- Magnetic field: DC earth field
- Absence of any external alternating magnetic fields.
- Absence of electric fields
- Measurement for a current from DC to 65 Hz sinusoidal
- Impedance of the measuring instrument: > 1 MΩ ≤ 100 pF.

<sup>(2)</sup> Phase shift "absolute value" (unsigned)

<sup>(3)</sup> Outside the reference domain

#### To order

PAC25 AC/DC current clamp with User's Manual and battery

#### Reference

P01120125

# AC/DC current clamp

## PAC26 model

PAC Series

<b>Current</b>	100 A AC 150 A DC	1,000 A AC 1,400 A DC
<b>Output</b>	10 mV/A	1 mV/A

### DESCRIPTION

The PAC26 model accurately measures AC or DC currents by making use of the Hall effect principle. This clamp with mV output is equipped with an automatic DC zero system and a deactivatable Auto Power Off (APO) function. It can be powered by a standard mains power pack via a Micro USB connector.

### ELECTRICAL SPECIFICATIONS

- Current calibre:**  
0.2 A AC .. 100 A AC (150 A peak) / 0.4 A DC .. 150 A DC  
0.5 A AC .. 1,000 A AC (1,400 A peak) / 0.5 A DC .. 1,400 A DC
- Output signal:**  
10 mV AC+DC / A AC+DC (1.5 V for 150 A)  
1 mV AC+DC / A AC+DC (1.4 V for 1,400 A)
- Accuracy and phase shift <sup>(1)</sup>:**

#### ■ Calibre 150 A

Primary current	0.5 A .. 1 A	1 A .. 40 A	40 A .. 100 A	100 A .. 150 A (DC only)
Accuracy in % of output signal	≤ 3 % + 5 mV	≤ 3 % + 5 mV	≤ 1.5 %	≤ 1.5 %
Phase shift <sup>(2)</sup>	Not specified	≤ 2°	≤ 2°	-

#### ■ 1,400 A calibre

Primary current	0.5 A .. 3 A	3 A .. 100 A	100 A .. 200 A	200 A .. 800 A	800 A .. 1,000 A	1,000 A .. 1,400 A (DC only)
Accuracy in % of output signal	≤ 1.5 % + 1 mV	≤ 1.5 % + 1 mV	≤ 2.5 %	≤ 2.5 %	≤ 4 %	≤ 5 %
Phase shift <sup>(3)</sup>	Not specified	≤ 2°	≤ 2°	≤ 1.5°	≤ 1.5°	-

- Bandwidth:**  
DC .. 30 kHz (-3 dB) (depending on current value)
- Insertion impedance:**  
0.05 mΩ @ 400 Hz, 0.14 mΩ @ 1 kHz
- Maximum currents:**  
3,000 A DC or 1,000 A AC permanent for a frequency < 1 kHz (limitation proportional to the reciprocal of one third of the frequency beyond that)
- DC zero adjustment:**  
Automatic, by 40 - 60 mA increments
- AC noise output:**
  - 150 A calibre: ≤ 3 mV or 0.3 A peak-peak
  - 1,400 A calibre: ≤ 1 mV or 1 A peak-peak
- Power supply:**  
9 V alkaline battery (NEDA 1604A, IEC 6LR61)  
5 V DC Micro USB type B
- Battery life:**  
50 hours typical
- Consumption:**  
10 mA typical (battery)  
31 mA typical (µUSB 5 V)
- "ON" LED:**  
"Lit" = In operation & battery level OK  
"Flashing" = remaining battery life < 4 hours  
"Colour = green" = APO ON  
"Colour = yellow" = APO OFF
- "OL" LED:**  
Overload indication: current measured too high for the calibre used

- Influence of power supply voltage:**  
None
- Influence of temperature:**  
≤ 3 % variation over the whole operating temperature range
- Influence of relative humidity:**  
≤ 0.5% from 10 % to 85 % RH at room temperature
- Influence of an adjacent conductor carrying a 50 Hz alternating current, 23 mm away from the clamp:**  
< 10 mA/A
- Influence of a 400 A/m external field @ 50 Hz:**  
< 1.3 A
- Influence of the position of a Ø 20 mm conductor in the jaws:**  
≤ 0.5 %
- Influence of the frequency <sup>(4)</sup>:**
  - 150 A calibre:  
10 Hz .. 400 Hz: ≤ 1 % of Vs  
400 Hz .. 7 kHz: ≤ 3.5 % of Vs  
7 kHz .. 30 kHz: see curve
  - 1,400 A calibre:  
10 Hz .. 400 Hz: ≤ 1 % of Vs  
400 Hz .. 10 kHz: ≤ 3.5 % of Vs  
10 kHz .. 30 kHz: see curve
- Common mode rejection:**  
> 65 dB A/V @ 50 Hz

- Remanence:**

0 to 100 A DC:	2.8 A typical
0 to 200 A DC:	3.5 A typical
0 to 400 A DC:	5 A typical
0 to 800 A DC:	5.3 A typical
0 to 1,200 A DC:	5.7 A typical
0 to 1,400 A DC:	5.8 A typical

### MECHANICAL SPECIFICATIONS

- Maximum jaw opening:**  
39 mm
- Clamping capacity:**  
Cables: Ø 39 mm  
Ø 25.4 mm x 2  
Busbars: 1 bar 50 x 12.5 mm  
2 bars 50 x 5 mm or 31.5 x 10 mm  
3 bars 25 x 8 mm  
4 bars 25 x 5 mm
- Output:**  
1.5 m double-insulated cable with male safety plugs (4 mm)
- Dimensions:**  
236.5 x 97 x 44 mm
- Weight:**  
520 g with battery
- Operating temperature:**  
-10 °C to +55 °C
- Storage temperature:**  
-40 °C to +80 °C



# AC/DC current clamp

## PAC26 model

PAC Series

- **Max. temperature of clamped conductor (measured):**  
+90 °C (may spike at +110 °C)
- **Max temperature of jaws:**  
+80 °C
- **Relative humidity for operation:**  
0 to 85 % RH with a linear decrease above 35 °C
- **Operating altitude:**  
0 to 2,000 m

- **Enclosure ingress protection:**  
IP 40 (IEC 60529)
- **Fall height:**  
1 m (IEC 60068-2-32)
- **Self-extinguishing capability**  
UL94 V1
- **Colours:**  
Casing: dark grey  
Jaws: red

### SAFETY SPECIFICATIONS

- **Electrical:**  
Type A appliance with double or reinforced insulation between the primary, the secondary and the grippable part below the guard as per IEC 61010-1 & IEC 61010-2-032  
- 600 V category III, pollution degree 2  
- 300 V category IV, pollution degree 2
- **Electromagnetic compatibility (EMC):**  
Complies with IEC 61326-1: 2012 (portable instrument)

### CURVES

150 A calibre

1,400 A calibre

DC linearity

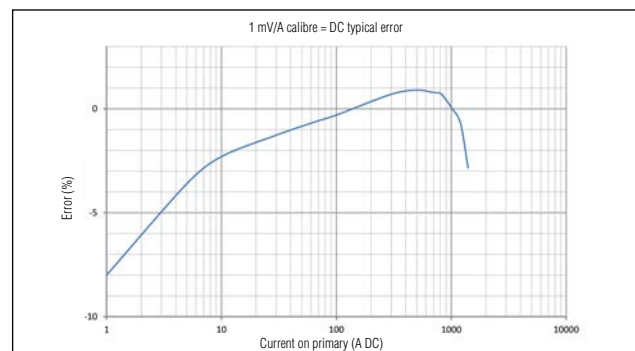
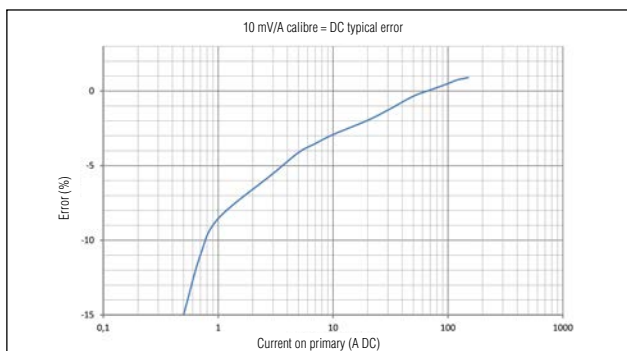

AC linearity

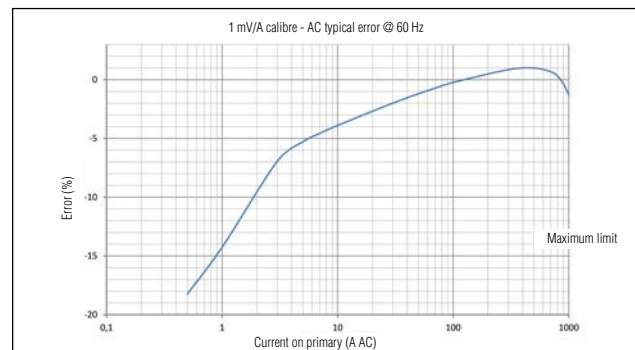
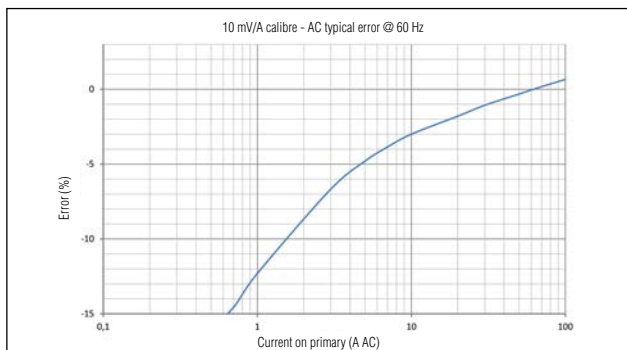

Phase shift

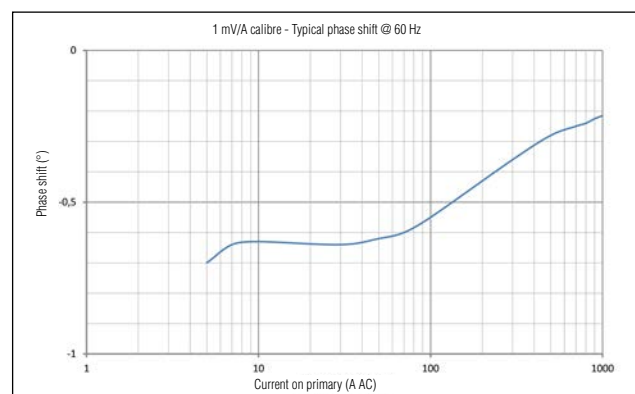
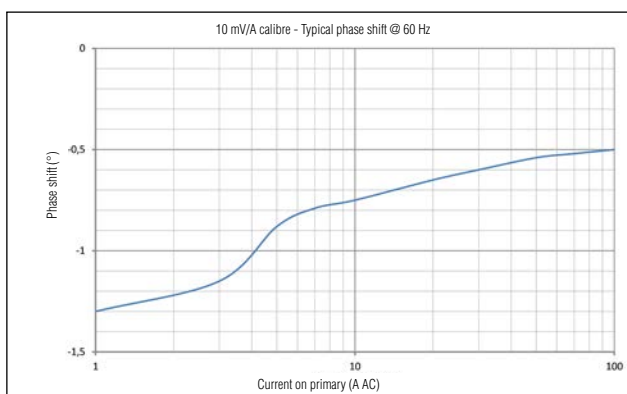

### CURVES

Limitation of measurable current depending on frequency

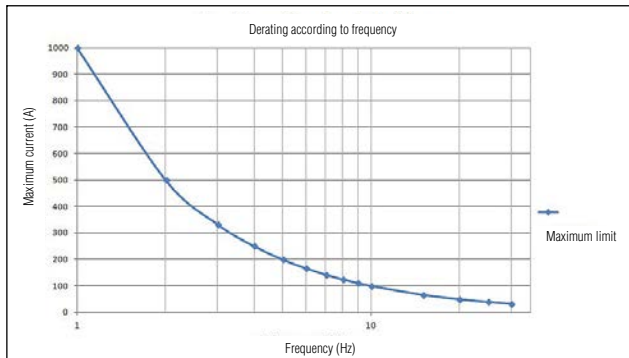

150 A calibre

1,400 A calibre

Frequency response

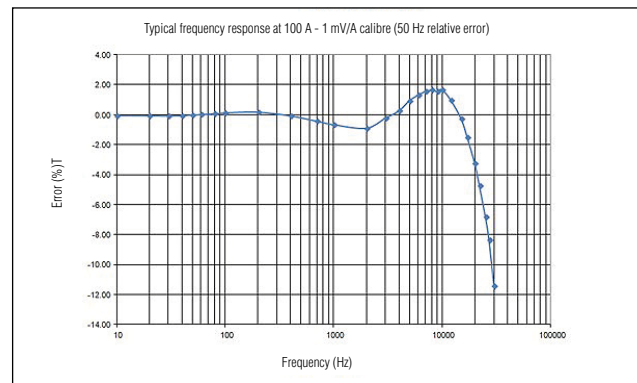
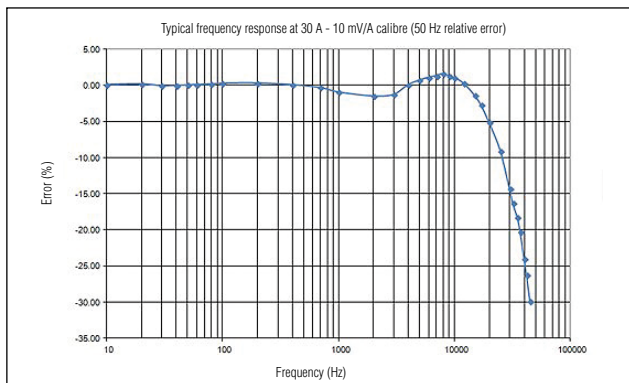

Phase shift according to frequency

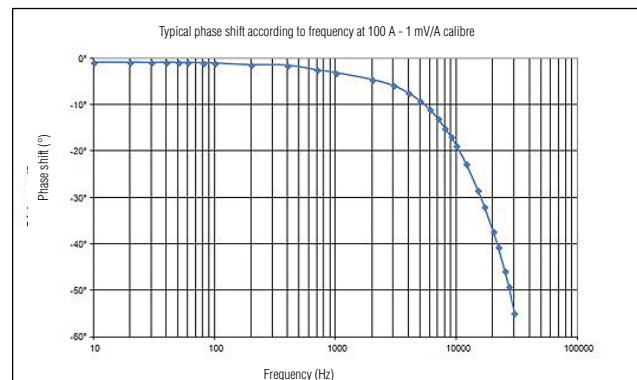

- <sup>(1)</sup> Conditions of reference:
- Temperature & humidity: 23 °C ± 5 °K, 20 % to 75 % HR
  - Power supply: by 6 V and 9 V battery or µUSB 5 ± 0.1 V DC,
  - Conductor position centred on the clamp locators
  - Magnetic field: DC earth field
  - Absence of any external alternating magnetic fields.
  - Absence of electric fields
  - Measurement for a current from DC to 65 Hz sinusoidal
  - Impedance of the measuring instrument: > 1 MΩ ≤ 100 pF.

<sup>(2)</sup> Phase shift "absolute value" (unsigned)

<sup>(3)</sup> Outside the reference domain

To order	Reference
PAC26 AC/DC current clamp with User's Manual and battery	P01120126



## Modèle PAC27 (Isolated AC/DC current sensor)

<b>Current</b>	100 A AC 150 A DC	1,000 A AC 1,400 A DC
<b>Output</b>	10 mV/A	1 mV/A

### DESCRIPTION

The PAC27 model accurately measures AC or DC currents by making use of the Hall effect principle. This clamp with mV output on BNC (direct reading on oscilloscopes, etc.) is equipped with an automatic DC zero system and a deactivatable Auto Power Off (APO) function. It can be powered by a standard mains power pack via a Micro USB connector.

### ELECTRICAL SPECIFICATIONS

- **Current calibre:**  
0.2 A AC .. 100 A AC (150 A peak) / 0.4 A DC .. 150 A DC  
0.5 A AC .. 1,000 A AC (1,400 A peak) / 0.5 A DC .. 1,400 A DC
- **Output signal:**  
10 mV AC+DC / A AC+DC (1.5 V for 150 A)  
1 mV AC+DC / A AC+DC (1.4 V for 1,400 A)
- **Accuracy and phase shift <sup>(1)</sup>:**

#### ■ Calibre 150 A

Primary current	0.5 A .. 1 A	1 A .. 40 A	40 A .. 100 A	100 A .. 150 A (DC only)
Accuracy in % of output signal	≤ 3 % + 5 mV	≤ 3 % + 5 mV	≤ 1.5 %	≤ 1.5 %
Phase shift <sup>(2)</sup>	Not specified	≤ 2°	≤ 2°	-

#### ■ 1,400 A calibre

Primary current	0.5 A .. 3 A	3 A .. 100 A	100 A .. 200 A	200 A .. 800 A	800 A .. 1,000 A	1,000 A .. 1,400 A (DC only)
Accuracy in % of output signal	≤ 1.5 % + 1 mV	≤ 1.5 % + 1 mV	≤ 2.5 %	≤ 2.5 %	≤ 4 %	≤ 5 %
Phase shift <sup>(3)</sup>	Not specified	≤ 2°	≤ 2°	≤ 1.5°	≤ 1.5°	-

- **Bandwidth:**  
DC .. 30 kHz (-3 dB) (depending on current value)
- **Rise time (10 to 90 % of Vs)**  
≤ 11 μs
- **Fall time (90 to 10 % of Vs)**  
≤ 11 μs
- **10 % delay time:**  
≤ 10 μs
- **Insertion impedance:**  
0.05 mΩ @ 400 Hz, 3.4 mΩ @ 10 kHz
- **Maximum currents:**  
3,000 A DC or 1,000 A AC permanent for a frequency < 1 kHz (limitation proportional to the reciprocal of one third of the frequency beyond that)
- **DC zero adjustment:**
  - 150 A & 1,400 A calibres:  
Automatic, by 40 - 60 mA increments
- **AC noise output:**
  - 150 A calibre: ≤ 3 mV or 0.3 A peak-peak
  - 1,400 A calibre: ≤ 1 mV or 1 A peak-peak
- **Power supply:**  
9 V alkaline battery (NEDA 1604A, IEC 6LR61)  
5 V DC Micro USB type B
- **Battery life:**  
50 hours typical
- **Consumption:**  
10 mA typical (battery)  
31 mA typical (μUSB 5 V)

- **"ON" LED:**  
"Lit" = In operation & battery level OK  
"Flashing" = remaining battery life < 4 hours  
"Colour = green" = APO ON  
"Colour = yellow" = APO OFF
- **"OL" LED:**  
Overload indication: current measured too high for the calibre used
- **Influence of power supply voltage:**  
None
- **Influence of temperature:**  
≤ 3 % variation over the whole operating temperature range
- **Influence of relative humidity:**  
≤ 0.5% from 10 % to 85 % RH at room temperature
- **Influence of an adjacent conductor carrying a 50 Hz alternating current, 23 mm away from the clamp:**  
< 10 mA/A
- **Influence of a 400 A/m external field @ 50 Hz:**  
< 1.3 A
- **Influence of the position of a Ø 20 mm conductor in the jaws:**  
≤ 0.5 %
- **Influence of the frequency <sup>(4)</sup>:**
  - 150 A calibre:  
10 Hz .. 400 Hz: ≤ 1 % of Vs  
400 Hz .. 7 kHz: ≤ 3.5 % of Vs  
7 kHz .. 30 kHz: see curve

- 1,400 A calibre:  
10 Hz .. 400 Hz: ≤ 1 % of Vs  
400 Hz .. 10 kHz: ≤ 3.5 % of Vs  
10 kHz .. 30 kHz: see curve
- **Common mode rejection:**  
> 65 dB A/V @ 50 Hz
- **Remanence:**
  - 0 to 100 A DC: 2.8 A typical
  - 0 to 200 A DC: 3.5 A typical
  - 0 to 400 A DC: 5 A typical
  - 0 to 800 A DC: 5.3 A typical
  - 0 to 1,200 A DC: 5.7 A typical
  - 0 to 1,400 A DC: 5.8 A typical

### MECHANICAL SPECIFICATIONS

- **Maximum jaw opening:**  
39 mm
- **Clamping capacity:**  
Cables: Ø 39 mm  
Ø 25.4 mm x 2  
Busbars: 1 bar 50 x 12.5 mm  
2 bars 50 x 5 mm or 31.5 x 10 mm  
3 bars 25 x 8 mm  
4 bars 25 x 5 mm
- **Output:**  
2 m coaxial cable terminated by an isolated BNC plug
- **Dimensions:**  
236.5 x 97 x 44 mm



## PAC27 model (Isolated AC/DC current sensor)

- **Weight:**  
520 g with battery
- **Operating temperature:**  
-10 °C to +55 °C
- **Storage temperature:**  
-40 °C to +80 °C
- **Max. temperature of clamped conductor (measured):**  
+90 °C (may spike at +110 °C)
- **Max temperature of jaws:**  
+80 °C
- **Relative humidity for operation:**  
0 to 85 % RH with a linear decrease above 35 °C
- **Operating altitude:**  
0 to 2,000 m
- **Enclosure ingress protection:**  
IP 40 (IEC 60529)
- **Fall height:**  
1 m (IEC 60068-2-32)
- **Self-extinguishing capability**  
UL94 V1
- **Colours:**  
Casing: dark grey  
Jaws: red

### SAFETY SPECIFICATIONS

- **Electrical:**  
Type A appliance with double or reinforced insulation between the primary, the secondary and the grippable part below the guard as per IEC 61010-1 & IEC 61010-2-032  
- 600 V category III, pollution degree 2  
- 300 V category IV, pollution degree 2
- **Electromagnetic compatibility (EMC):**  
Complies with IEC 61326-1: 2012 (portable instrument)

### CURVES

150 A calibre

1,400 A calibre

#### DC linearity

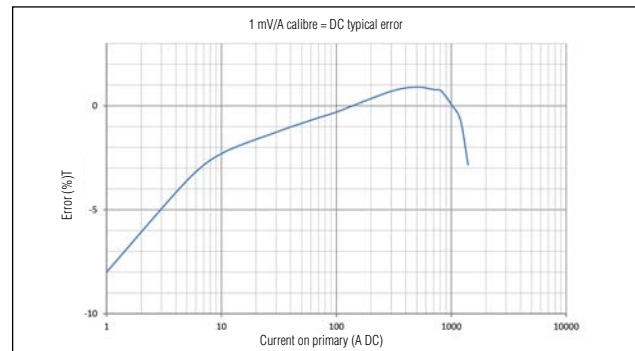
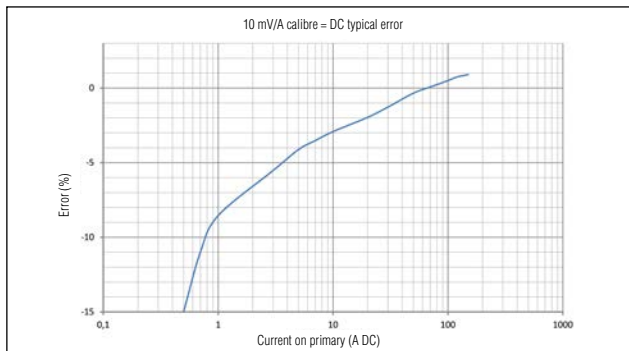

#### AC linearity

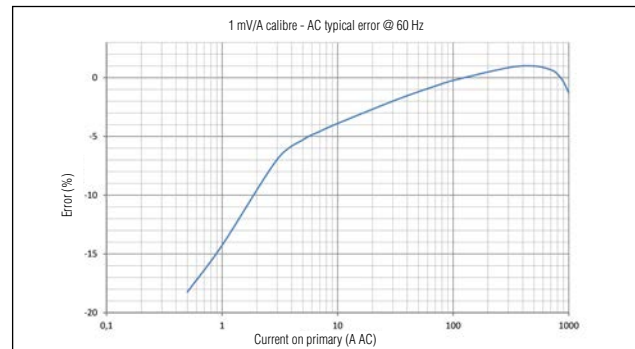
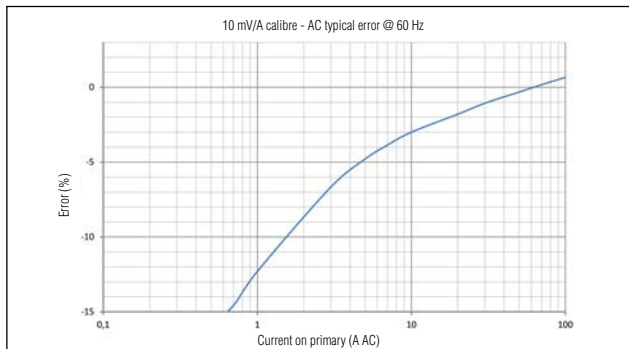

#### Phase shift

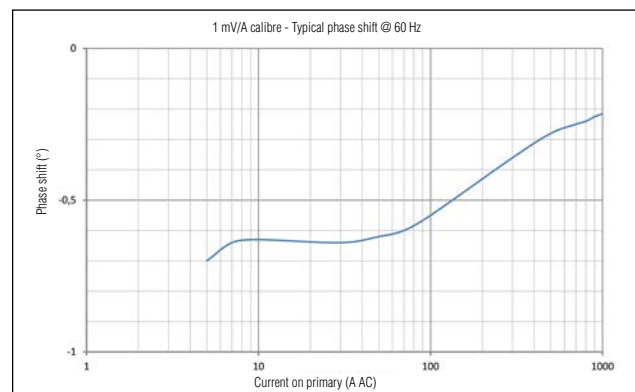
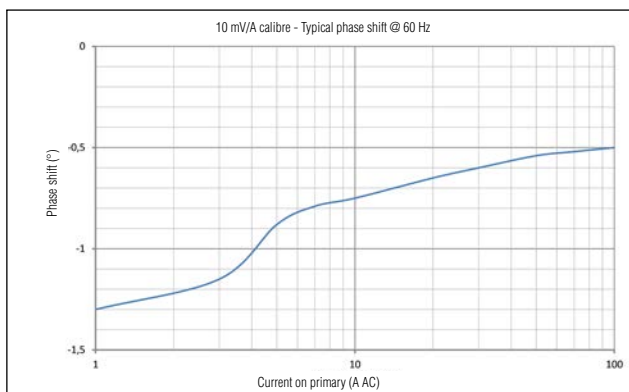

### CURVES

Limitation of measurable current depending on frequency

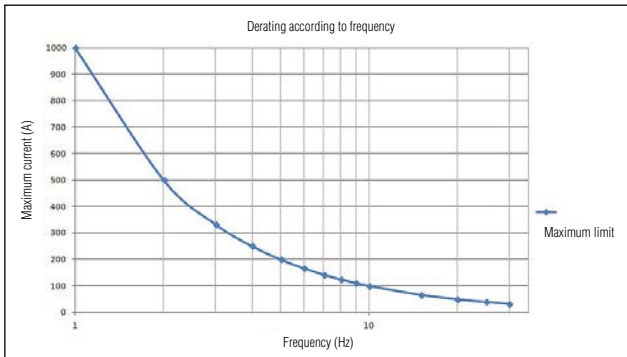

150 A calibre

1,400 A calibre

Frequency response

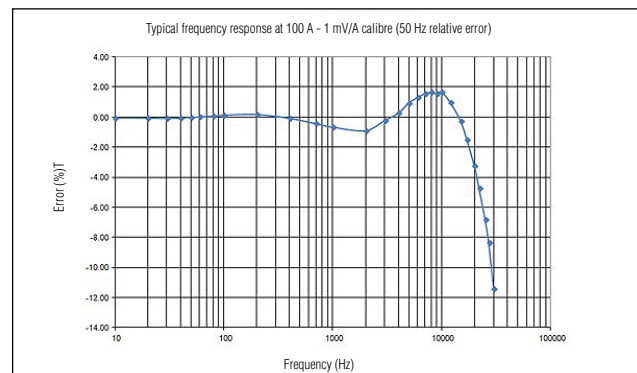
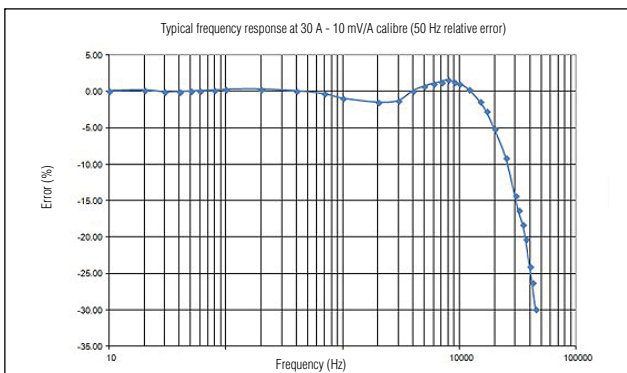

Phase shift according to frequency

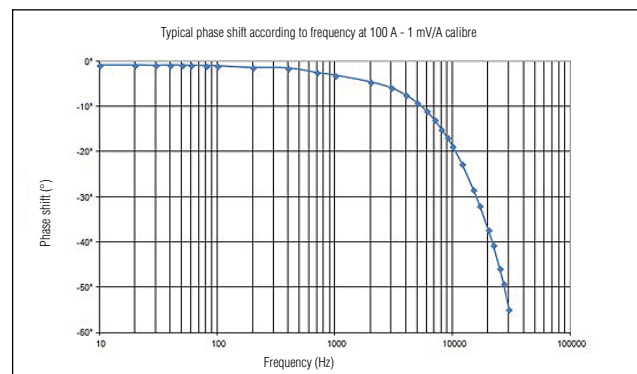
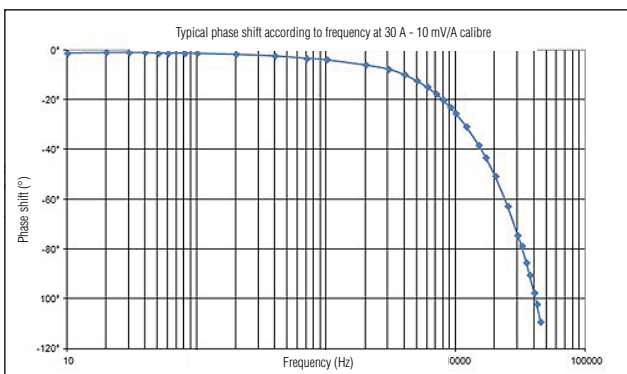

### CURVES

Pulse response

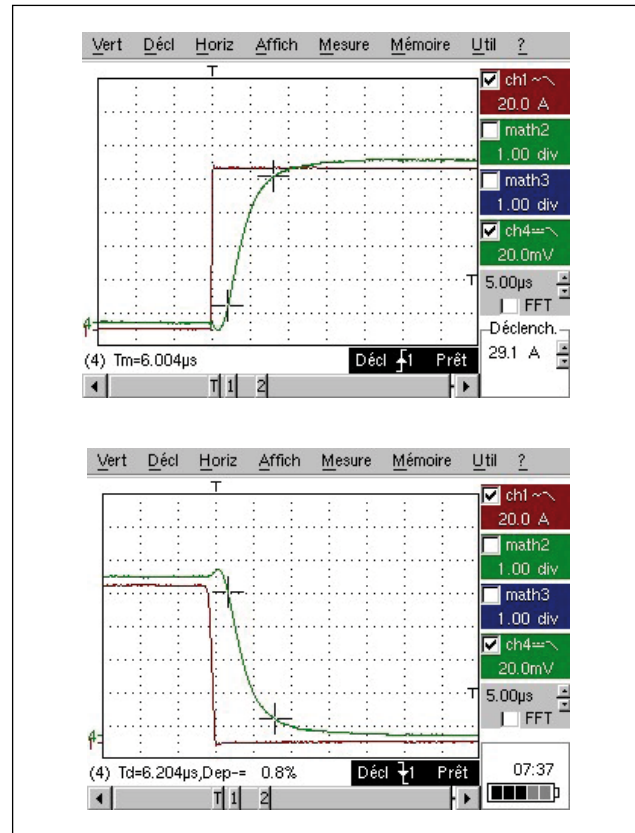
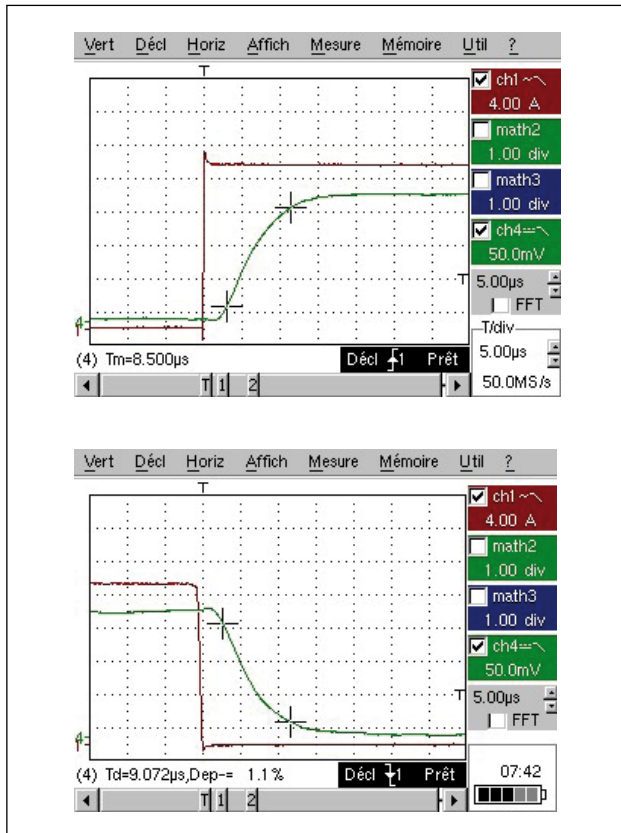

<sup>(1)</sup> Conditions of reference:

- Temperature & humidity: 23 °C ± 5 °K, 20 % to 75 % HR
- Power supply: by 6 V and 9 V battery or µUSB 5 ± 0.1 V DC,
- Conductor position centred on the clamp locators
- Magnetic field: DC earth field
- Absence of any external alternating magnetic fields.
- Absence of electric fields
- Measurement for a current from DC to 65 Hz sinusoidal
- Impedance of the measuring instrument: > 1 MΩ ≤ 100 pF.

<sup>(2)(3)</sup> Phase shift "absolute value" (unsigned)

<sup>(4)</sup> Outside the reference domain

To order	Reference
<b>PAC27</b> AC/DC current clamp for oscilloscope with User's Manual and battery	P01120127