



RIGOL

# MSO8000A Series

## Digital Oscilloscope

Quick Guide

May. 2023



## **Guaranty and Declaration**

### **Copyright**

© 2023 RIGOL TECHNOLOGIES CO., LTD. All Rights Reserved.

### **Trademark Information**

RIGOL® is the trademark of RIGOL TECHNOLOGIES CO., LTD.

### **Software Version**

Software upgrade might change or add product features. Please acquire the latest software version from **RIGOL** website or contact **RIGOL** to upgrade the software.

### **Notices**

- RIGOL products are covered by P.R.C. and foreign patents, issued and pending.
- RIGOL reserves the right to modify or change parts of or all the specifications and pricing policies at the company's sole decision.
- Information in this publication replaces all previously released materials.
- Information in this publication is subject to change without notice.
- RIGOL shall not be liable for either incidental or consequential losses in connection with the furnishing, use, or performance of this manual, as well as any information contained.
- Any part of this document is forbidden to be copied, photocopied, or rearranged without prior written approval of RIGOL.

### **Product Certification**

RIGOL guarantees that this product conforms to the national and industrial standards in China as well as the ISO9001:2015 standard and the ISO14001:2015 standard. Other international standard conformance certifications are in progress.

### **Contact Us**

If you have any problem or requirement when using our products or this manual, please contact RIGOL.

E-mail: [service@rigol.com](mailto:service@rigol.com)

Website: <http://www.rigol.com>

# 1 General Safety Summary

Please review the following safety precautions carefully before putting the instrument into operation so as to avoid any personal injury or damage to the instrument and any product connected to it. To prevent potential hazards, please follow the instructions specified in this manual to use the instrument properly.

- 1 Only the exclusive power cord designed for the instrument and authorized for use within the destination country could be used.
- 2 Ensure that the instrument is safely grounded.
- 3 Observe all terminal ratings.
- 4 Use proper overvoltage protection.
- 5 Do not operate without covers.
- 6 Do not insert objects into the air outlet.
- 7 Use the proper fuse.
- 8 Avoid circuit or wire exposure.
- 9 Do not operate the instrument with suspected failures.
- 10 Provide adequate ventilation.
- 11 Do not operate in wet conditions.
- 12 Do not operate in an explosive atmosphere.
- 13 Keep instrument surfaces clean and dry.
- 14 Prevent electrostatic impact.
- 15 Handle with caution.



## WARNING

**Equipment meeting Class A requirements may not offer adequate protection to broadcast services within residential environment.**

## 2 Safety Notices and Symbols

### Safety Notices in this Manual:



#### **WARNING**

Indicates a potentially hazardous situation or practice which, if not avoided, will result in serious injury or death.



#### **CAUTION**

Indicates a potentially hazardous situation or practice which, if not avoided, could result in damage to the product or loss of important data.

### Safety Notices on the Product:

- **DANGER**

It calls attention to an operation, if not correctly performed, could result in injury or hazard immediately.

- **WARNING**

It calls attention to an operation, if not correctly performed, could result in potential injury or hazard.

- **CAUTION**

It calls attention to an operation, if not correctly performed, could result in damage to the product or other devices connected to the product.

### Safety Symbols on the Product:



**Hazardous Voltage**



**Safety Warning**



**Protective Earth Chassis Ground Terminal**

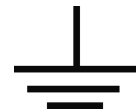
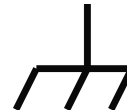

**Test Ground**

## 3 Care and Cleaning

---

### Care

Do not store or leave the instrument where it may be exposed to direct sunlight for long periods of time.

### Cleaning

Clean the instrument regularly according to its operating conditions.

1. Disconnect the instrument from all power sources.
2. Clean the external surfaces of the instrument with a soft cloth dampened with mild detergent or water. Avoid having any water or other objects into the chassis via the heat dissipation hole. When cleaning the LCD, take care to avoid scarifying it.



### CAUTION

To avoid damage to the instrument, do not expose it to caustic liquids.



### WARNING

To avoid short-circuit resulting from moisture or personal injuries, ensure that the instrument is completely dry before connecting it to the power supply.

## 4 Document Overview

This manual gives you a quick review about the front and rear panel of MSO8000A series, the user interface, and the basic operation method.



### TIP

For the latest version of this manual, download it from the official website of RIGOL (<http://www.rigol.com>).

### Publication Number

QGA31100-1110

### Format Conventions in this Manual:



#### 1. Key

The front panel key is denoted by menu key icon. For example,  indicates the "Default" key.

#### 2. Menu

The menu items are denoted by the format of "Menu Word (Bold) + Character Shading". For example, **System** denotes the "System" menu item under the  menu.





#### 3. Operation Procedures:





">" denotes the next step of operation. For example,  > **System** denotes that first press , and then press the **System** key.

#### 4. Connector

The connectors on the front or rear panel are usually denoted by the format of "Connector Name (Bold) + Square Brackets (Bold)". For example, **[TRIG OUT]**.

#### 5. Knob

Label	Knob	Label	Knob
Horizontal  <b>SCALE</b>	Horizontal Scale Knob	Vertical  <b>SCALE</b>	Vertical Scale Knob
Horizontal  <b>POSITION</b>	Horizontal Position Knob	Vertical  <b>OFFSET</b>	Vertical Offset Knob

Label	Knob	Label	Knob
Wave Vertical  <u>SCALE</u>	Vertical Scale Knob	Trigger  <u>LEVEL</u>	Trigger Level Knob
Wave Vertical  <u>POSITION</u>	Wave Vertical Position Knob		Multifunction knob

### Content Conventions in this Manual:

MSO8000A series includes the following models. Unless otherwise specified, this manual takes MSO8204A as an example to illustrate the functions and operation methods of the MSO8000A series.

Model	Max. Analog Bandwidth	No. of Digital Channels	No. of Analog Channels	No. of AWG Channels
MSO8074A	750 MHz	16	4	2
MSO8154A	1.5 GHz	16	4	2
MSO8204A	2 GHz	16	4	2

## 5 General Inspection

---

### 1. Inspect the packaging

If the packaging has been damaged, do not dispose the damaged packaging or cushioning materials until the shipment has been checked for completeness and has passed both electrical and mechanical tests.

The consigner or carrier shall be liable for the damage to the instrument resulting from shipment. RIGOL would not be responsible for free maintenance/rework or replacement of the instrument.

### 2. Inspect the instrument

In case of any mechanical damage, missing parts, or failure in passing the electrical and mechanical tests, contact your RIGOL sales representative.

### 3. Check the accessories

Please check the accessories according to the packing lists. If the accessories are damaged or incomplete, please contact your RIGOL sales representative.

### Recommended Calibration Interval

RIGOL suggests that the instrument should be calibrated every 18 months.



## 6 Product Overview

MSO8000A series digital oscilloscope developed by RIGOL is a medium and high-end mixed signal digital oscilloscope designed based on the UltraVision II technical platform. With the analog bandwidth up to 2 GHz, the digital oscilloscope integrates 7 instruments into one, with 500 Mpts memory depth, sound waveform display effects, excellent waveform capture rate, and powerful data analysis functions. Many of its specifications have reached the top level in the industry. Meanwhile, it supports the real-time eye diagram measurement and jitter analysis. Its cost-effective features and high performance make it prominent as the 2 GHz mixed signal digital oscilloscope.

The following section introduces the front panel, rear panel, and the main interface (LCD) of the digital oscilloscope.

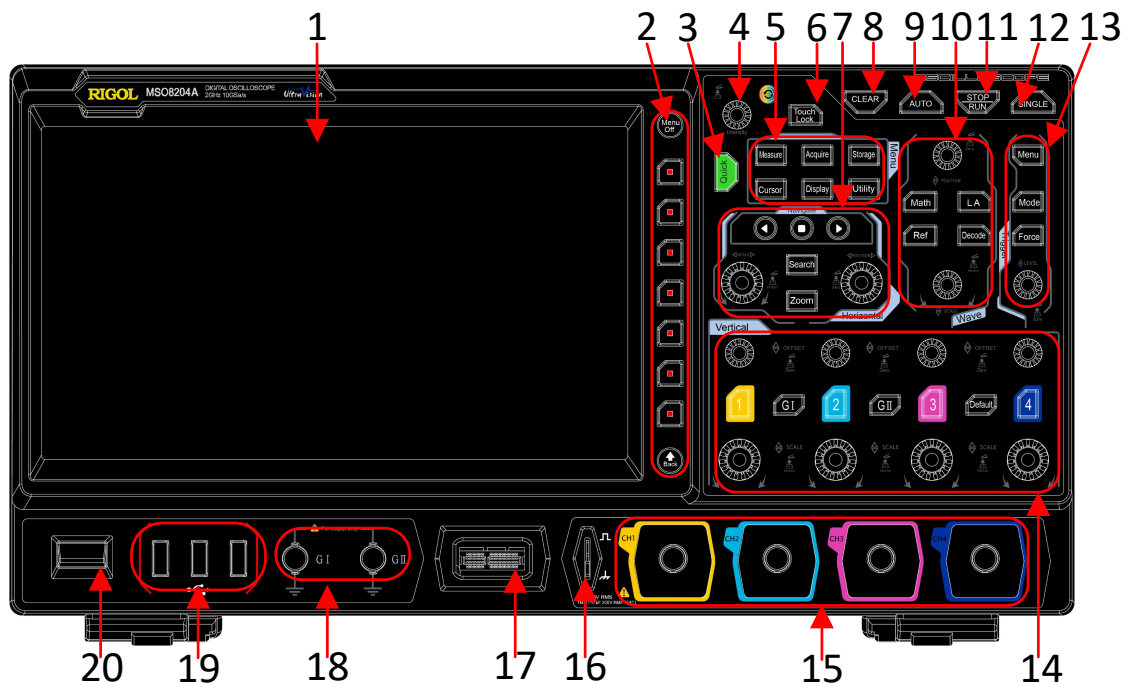

**Figure 6.1 Front Panel**

- |   |                              |    |   |
|---|------------------------------|----|---|
| 1 | Capacitive Touch Screen      | 11 | RUN/STOP Key  |
| 2 | Function Menu Operation Keys | 12 | Single Trigger Control Key                                |
| 3 | Quick Key (Shortcut Key)     | 13 | Trigger Control System                                    |
| 4 | Multifunction Knob           | 14 | Vertical Control System                                   |
| 5 | Common Operation Keys        | 15 | Analog Channel Input Terminals                            |
| 6 | Touch Lock Key               | 16 | Probe Compensation Signal Output Terminal/Ground Terminal |
| 7 | Horizontal Control System    | 17 | Digital Channel Input                                     |

- |    |                           |    |  |
|----|---------------------------|----|--|
| 8  | CLEAR key                 | 18 | Dual-channel Function/Arbitrary Waveform Generator Output Terminals <sup>[1]</sup> |
| 9  | Auto Waveform Display Key | 19 | USB HOST Interface   |
| 10 | Waveform Control System   | 20 | Power Key  |



**NOTE**

[1]: This function is only available for the model installed with the MSO8000-AWG option.

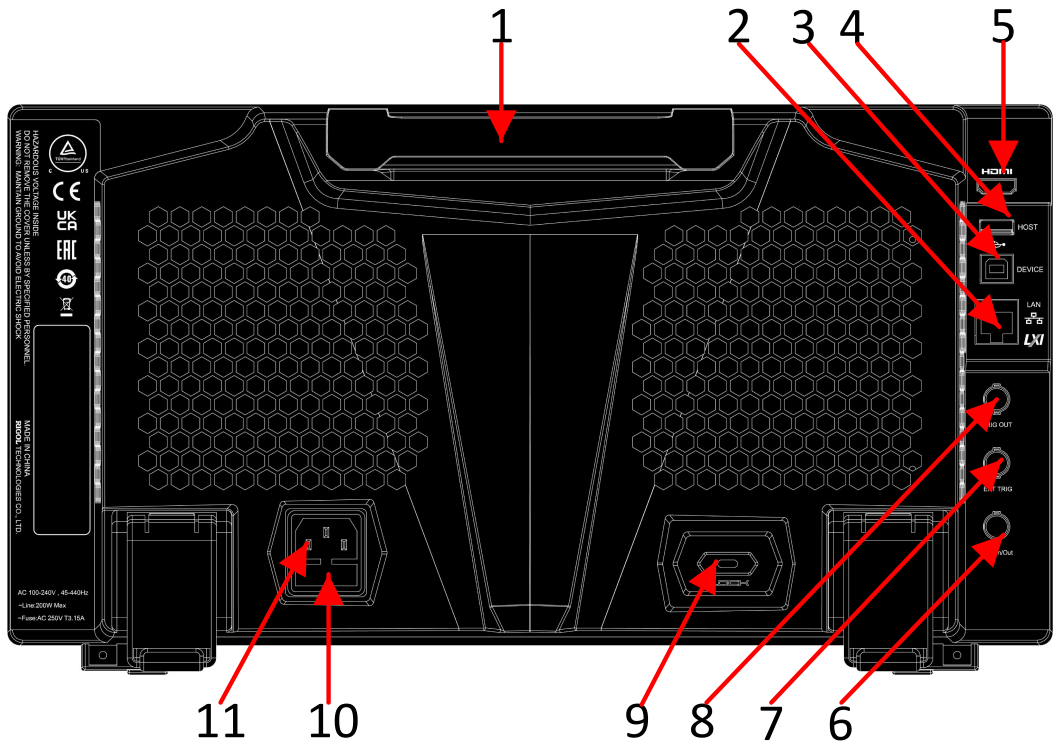

**Figure 6.2 Rear Panel**

- |    |                               |
|----|-------------------------------|
| 1  | Handle                        |
| 2  | LAN Interface                 |
| 3  | USB DEVICE Interface          |
| 4  | USB HOST Interface            |
| 5  | HDMI Video Output             |
| 6  | 10M In/Out                    |
| 7  | EXT TRIG                      |
| 8  | Trigger Output Interface      |
| 9  | Kensington Security Lock Hole |
| 10 | Fuse                          |
| 11 | AC Power Cord Connector       |

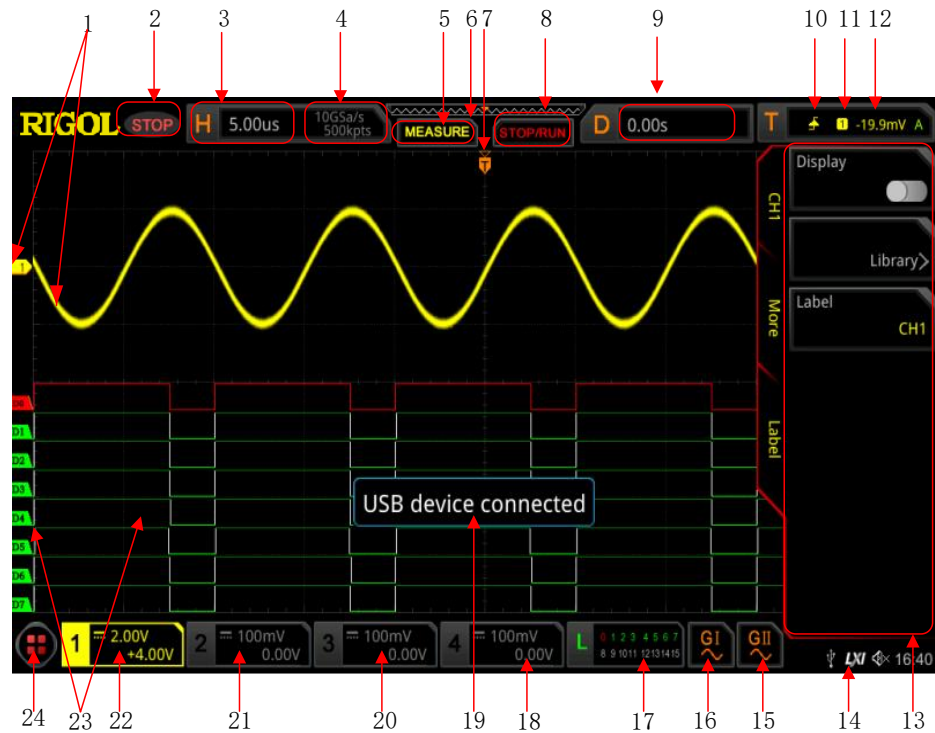

Figure 6.3 User Interface

1	Analog Channel Label and Waveform	13	Operation Menu
2	Operating Status	14	Notification Area
3	Horizontal Scale	15	AWG 2 Waveform Label
4	Sample Rate and Memory Depth	16	AWG 1 Waveform Label
5	Auto Measurement Label	17	Digital Channel Status Area
6	Waveform Memory	18	CH4 Status Label
7	Trigger Position	19	Message Box
8	Run/Stop Label	20	CH3 Status Label
9	Horizontal Position	21	CH2 Status Label
10	Trigger Type	22	CH1 Status Label
11	Trigger Source	23	Digital Channel Label and Waveform
12	Trigger LEVEL/Threshold Level	24	Function Navigation

## 7 To Prepare for Use

### 7.1 To Adjust the Supporting Legs

Adjust the supporting legs properly to use them as stands to tilt the oscilloscope upwards for stable placement of the oscilloscope as well as better operation and observation. Users can also fold the supporting legs when the instrument is not in use for easier storage or shipment, as shown in the figure below.

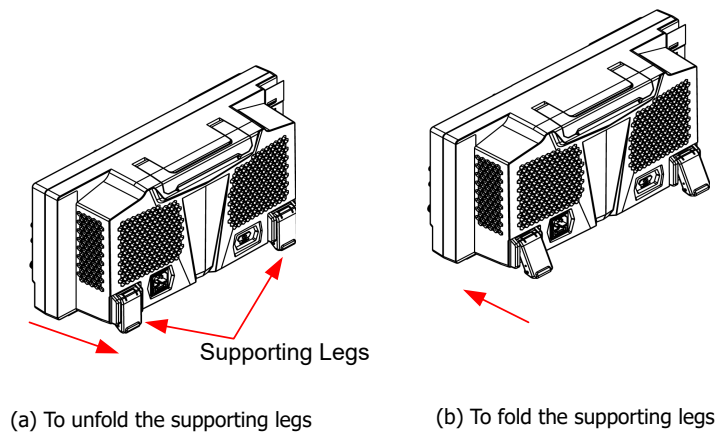

Figure 7.1 To Adjust the Supporting Legs

### 7.2 To Connect to AC Power

The input AC power requirements of the oscilloscope are 100 V-240 V, 45 Hz-440 Hz. Please use the power cord provided in the accessories to connect the oscilloscope to the AC power source, as shown in the figure below.

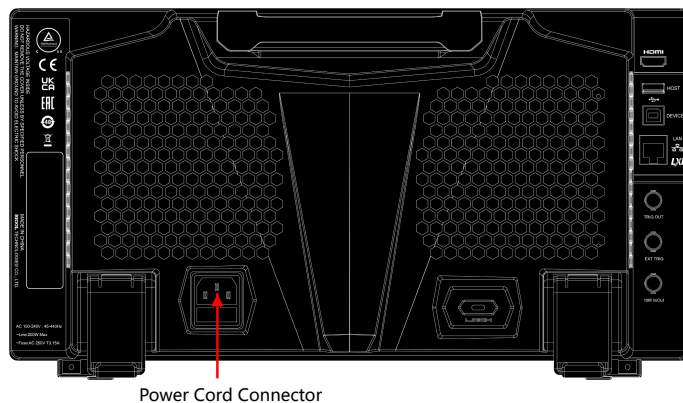



Figure 7.2 To Connect to AC Power

**WARNING**

To avoid electric shock, ensure that the instrument is correctly grounded.

## 7.3 Turn-on Checkout

When the oscilloscope is connected to power, press the Power key at the lower-left corner of the front panel to start the oscilloscope. (You can also press  > **System** > **Power status**, and select "Switch On". After the instrument is connected to power source, it will start directly.) You can also enable the touch screen to perform the above operations.) During the start-up process, all the backlights of the front-panel keys are illuminated for a few seconds. The oscilloscope starts to perform a series of self-tests. After the self-test, the splash screen is displayed.

**NOTE**

Restart and Shutdown:

1. Enable the touch screen and then tap the function navigation icon  at the lower-left corner of the touch screen to enable the function navigation.
2. Tap the "Restart" icon, and then you can select "Restart" or "Shutdown", as shown in the figure below.

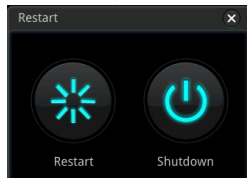

3. If you tap "Restart" , the oscilloscope powers off and then automatically restarts again.

If you tap "Shutdown" , the oscilloscope powers off (you can also press the Power key at the lower-left corner of the front panel to turn off the oscilloscope).

## 7.4 To Set the System Language

MSO8000A series digital oscilloscope supports multiple system languages. You can press  > **Language** to set the system language.

## 7.5 To Connect the Probe

RIGOL provides the passive probe, the active probe, and the logic probe for the MSO8000A series. For specific probe models, please refer to *MSO8000A Datasheet*.

For detailed technical information of the probes, please refer to the corresponding Probe User Guide.

**Connect the passive probe:**

1. Connect the BNC terminal of the probe to an analog channel input terminal of the oscilloscope on the front panel as shown in *Figure 7.3*.
2. Connect the ground alligator clip or spring of the probe to the circuit ground terminal, and then connect the probe tip to the circuit point to be tested.

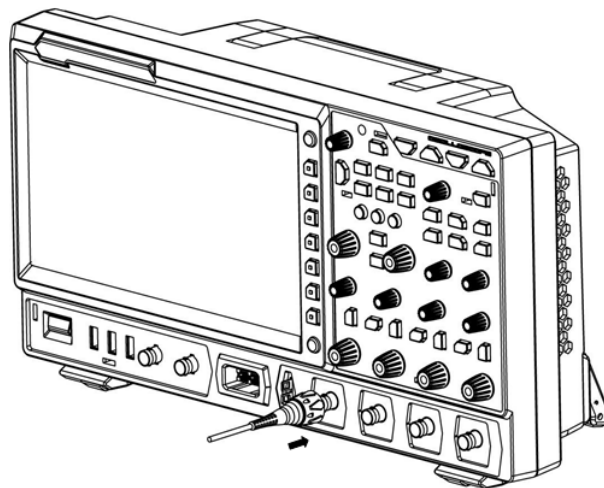

**Figure 7.3 Connect the Passive Probe**

After you connect the passive probe, check the probe function and probe compensation adjustment before making measurements. For detailed procedures, refer to "*Function Inspection*" and "*Probe Compensation*".

**Connect the active probe:**

Take RP7150 (active differential probe head) as an example.

1. Connect the probe head to the preamp of the active probe, as shown in *Figure 7.4*.

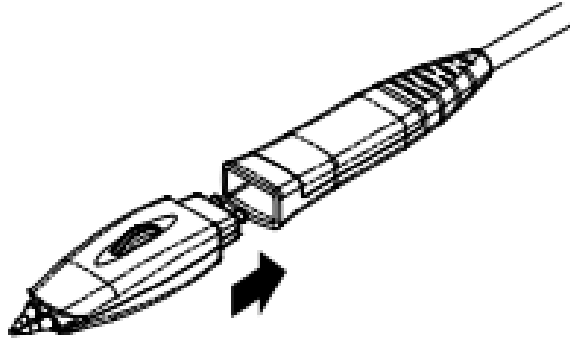

**Figure 7.4 To Connect the Probe Head to the Preamp of the Active Probe**

2. Connect the other end of the preamp to an analog channel input terminal of the oscilloscope on the front panel, as shown in the figure below.
3. Note that you need to push the probe to the due position to lock it firmly.

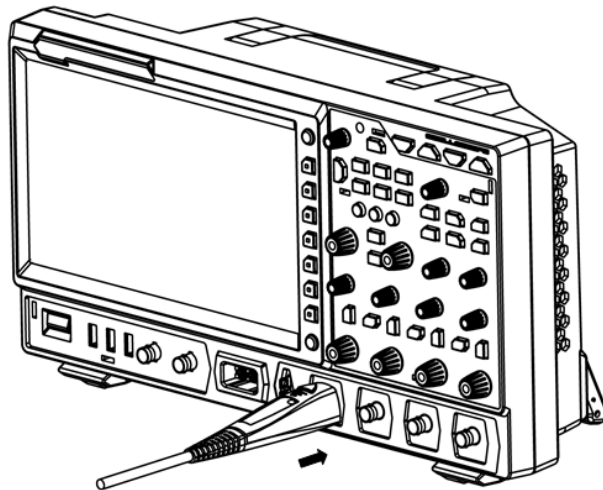

**Figure 7.5 Connect the Active Probe**

4. Use the probe's auxiliary device to connect the probe head to the circuit under test. For details about the probes, refer to *RP7000 Series Active Probe User Guide*.

After you connect the active probe, you can make probe calibration and offset voltage adjustment.

#### **Connect the logic probe**

1. Connect the output terminal of the logic probe to the digital channel input terminal on the front panel of the oscilloscope in the correct direction, as shown in *Figure 7.6*.

2. Connect the other terminal of the logic probe to the signal terminal under test.

RIGOL's MSO8000A series has a standard configuration of a logic probe RPL2316.

To apply to different application scenarios, RPL2316 provides three connection methods to connect the signal under test. For details, refer to *RPL2316 Logic Probe User Guide*.

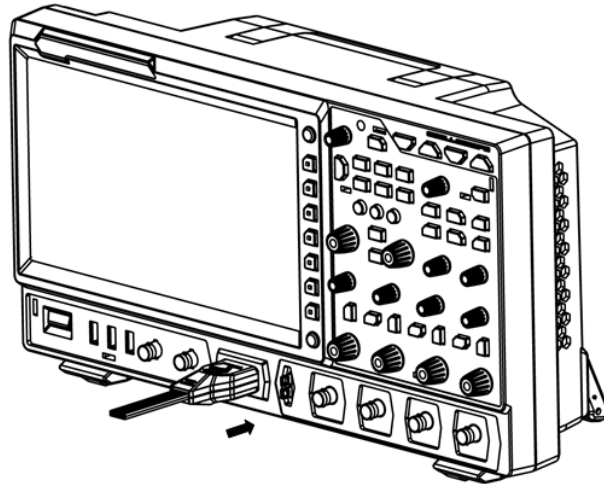

Figure 7.6 Connect the logic probe



#### NOTE

- Before you connect the logic probe to the signal under test, connect logic probe's adapter provided in the accessories to its corresponding channel group.
- The digital channel input terminal does not support hot plugging. Please do not insert or pull out the logic probe when the instrument is in power-on state.

## 7.6 Function Inspection

1. Press **Default** on the front panel, then a prompt message "Restore default settings?" is displayed. Press **OK** or tap **OK** to restore the instrument to its factory default settings.
2. Connect the ground alligator clip of the probe to the "Ground Terminal" as shown in [Figure 7.7](#).
3. Use the probe to connect the input terminal of CH1 of the oscilloscope and the "Compensation Signal Output Terminal" of the probe, as shown in [Figure 7.7](#).



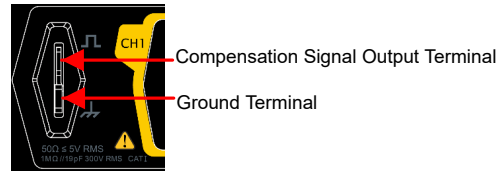



Figure 7.7 To Use the Compensation Signal

4. Set the probe attenuation to 10X, and then press .
5. Observe the waveform on the display. In normal condition, the square waveform as shown in *Figure 7.8* should be displayed.

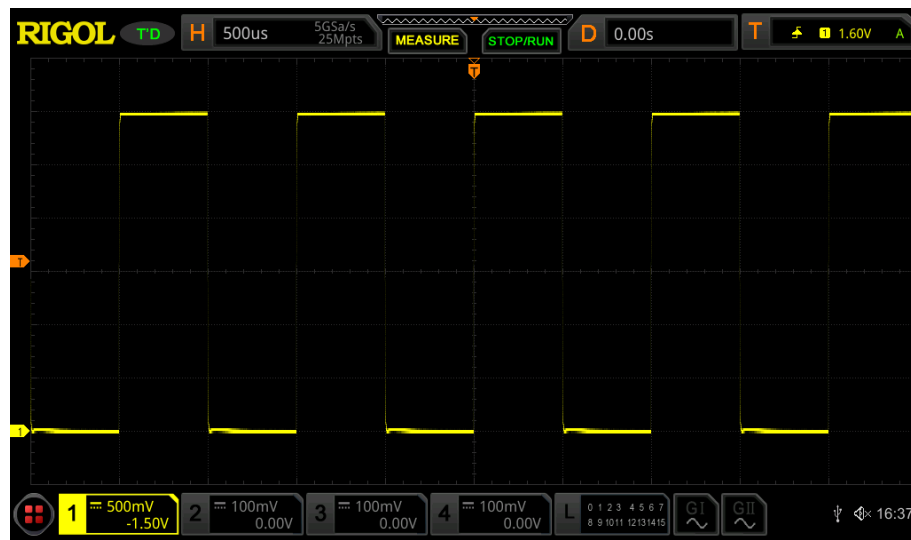

Figure 7.8 Square Waveform Signal

6. Use the same method to test the other channels. If the square waveforms actually shown do not match that in the figure above, please perform "*Probe Compensation*" introduced in the next section.



#### WARNING

To avoid electric shock when using the probe, please make sure that the insulated wire of the probe is in good condition. Do not touch the metallic part of the probe when the probe is connected to high voltage source.

## 7.7 Probe Compensation

When the probes are used for the first time, you should compensate the probes to make them match the input channels of the oscilloscope. Non-compensated or poorly compensated probes may cause measurement inaccuracy or errors. The probe compensation procedures are as follows:

1. Perform Step 1, 2, 3 and 4 specified in "*Function Inspection*".
2. Check the displayed waveforms and compare them with the waveforms shown in *Figure 7.9*.

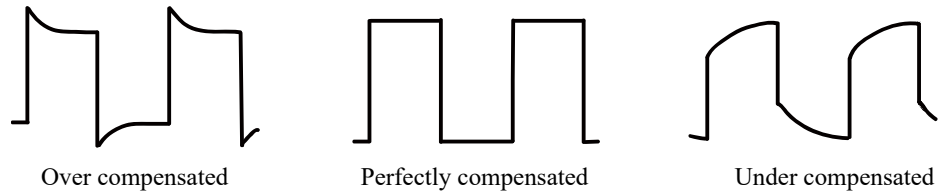

**Figure 7.9 Probe Compensation**

3. Use the probe compensation adjustment tool provided in the accessories to adjust the low-frequency compensation adjustment hole on the probe until the displayed waveform is consistent with the "Perfectly compensated" waveform shown in *Figure 7.9*.

## 8 Touch Screen Controls

MSO8000A series provides a 10.1-inch super large capacitive touch screen, which supports multi-touch and gesture operation. It has strong waveform display capability and excellent user experience. It features great convenience, high flexibility, and great sensitivity. The actions supported by the touch screen controls include tapping, pinching & stretching, dragging, and rectangle drawing.



### TIP

The touch screen function is available for all the menus displayed on the screen and the buttons enabled. In this manual, key operation descriptions are illustrated in details, and as for the touch screen function about some operations, refer to descriptions in relevant chapters.

### 8.1 Tap

Use one finger to touch the symbol or characters on the screen slightly, as shown in *Figure 8.1*. With the Tap gesture, you can perform the following operation:

- Tap the menu displayed on the screen to operate on the menu.
- Tap the function navigation icon  at the lower-left corner of the touch screen to open the function navigation.
- Tap the displayed numeric keypad to set the parameters.
- Tap the virtual keypad to set the label name and the filename.
- Tap the close button at the upper-right corner of the message box to close the prompt window.
- Tap other windows on the touch screen and operate on the windows.



**Figure 8.1 Tap Gesture**

## 8.2 Pinch & Stretch

Pinch or stretch two points on the screen with two fingers to zoom in or out the waveform. To zoom in the waveform, first pinch the two fingers and then stretch the fingers; to zoom out the waveform, first stretch the two fingers, and then pinch the fingers together, as shown in *Figure 8.2*. With the pinch&stretch gesture, you can perform the following operation:

- Pinching&stretching in the horizontal direction can adjust the horizontal time base of the waveform.
- Pinching&stretching in the vertical direction can adjust the vertical scale of the waveform.



Figure 8.2 Pinch & Stretch Gesture

## 8.3 Drag

Use one finger to select the object, and then drag the object to a destination place, as shown in *Figure 8.3*. With the drag gesture, you can perform the following operation:

- Drag the waveform to change its position or scale.
- Drag the window controls to change the position of the window (e.g. numeric keypad).
- Drag the marker to change the position of the marker.



Figure 8.3 Drag Gesture

## 8.4 Rectangle Drawing

Enable the function navigation, and then tap the "Draw rect" icon to switch to the rectangle drawing mode. Drag a finger from upper left to lower right across the screen to draw a rectangle on the screen, as shown in [Figure 8.4](#). Move your finger away from the screen, and then a menu is displayed on the screen. At this time, you can tap to select "Trigger zone A", "Trigger zone B", "Histogram", "Horizontal zoom in", "Vertical zoom in", or "Waveform zoom in". Drag a finger from lower right to upper left across the screen to draw a rectangle on the screen, as shown in [Figure 8.5](#). Move your finger away from the screen, and then a menu is displayed on the screen. At this time, you can tap to select "Trigger zone A", "Trigger zone B", "Histogram", "Horizontal zoom out", "Vertical zoom out", or "Waveform zoom out".

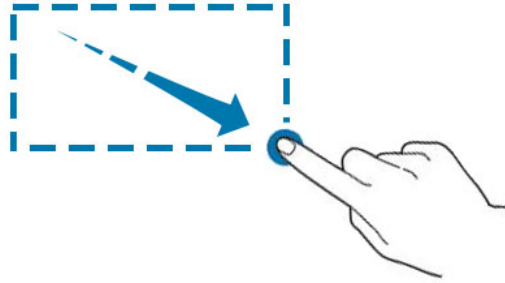

Figure 8.4 Rectangle Drawing Gesture(a)

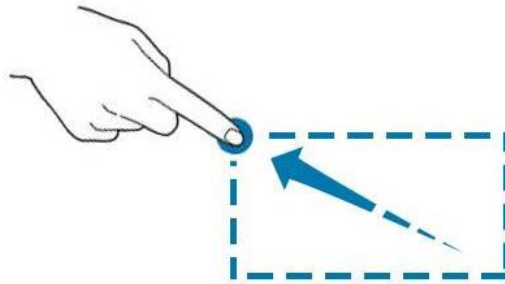



Figure 8.5 Rectangle Drawing Gesture(b)

- Select "Trigger zone A":
  - Draw the region for Trigger zone A;
  - Open Trigger zone A;
  - Open the "Zone Trigger" menu.
- Select "Trigger zone B":

- Draw the region for Trigger zone B;
- Open Trigger zone B:
- Open the "Zone Trigger" menu.
- Select "Histogram":
  - Draw the region for the histogram;
  - Open the "Histogram" menu.
- Select "Horizontal zoom in": expands the waveforms in the horizontal direction. Select "Horizontal zoom out": compresses the waveforms in the horizontal direction.
- Select "Vertical zoom in": expands the waveforms in the vertical direction. Select "Vertical zoom out": compresses the waveforms in the vertical direction.
- Select "Waveform zoom in": expands the waveforms both in the horizontal and vertical direction. Select "Waveform zoom out": compresses the waveforms both in the horizontal and vertical direction.



**TIP**

Tap the "Draw rect" icon to switch between the rectangle drawing and waveform operation modes.

Tap the "Draw rect" icon, if  is displayed, it indicates that the rectangle drawing mode is enabled. Tap the "Draw rect" icon, if  is displayed, it indicates that the waveform operation mode is enabled. By default, the waveform operation mode is enabled.

## 9 To Use the Built-in Help System

The help system of this oscilloscope provides instructions for all the function keys on the front panel and their corresponding menu keys. The steps for opening the built-in help system are as follows:



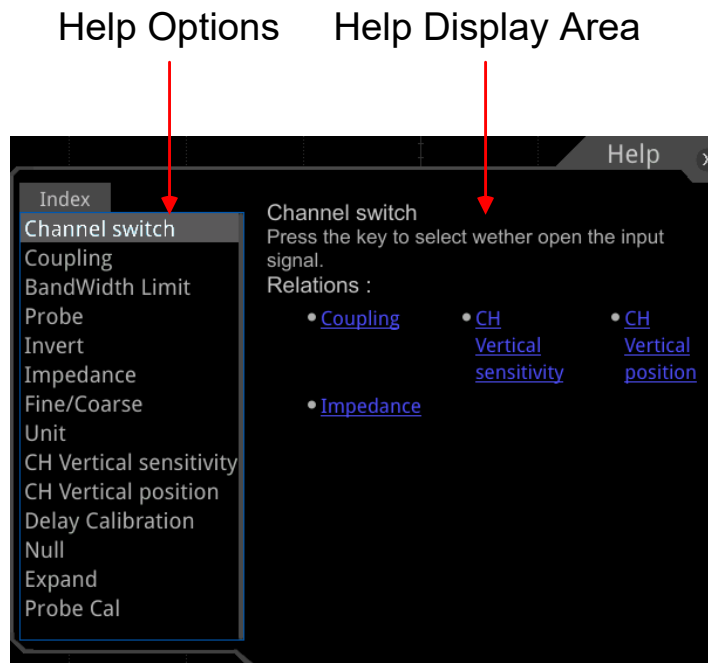

1. Press  > **System** > **Help**, and then the "Help" menu is displayed on the screen. You can also use the touch screen function, tap the navigation icon  at the lower-left corner of the touch screen to enable the function navigation. Tap the "Help" icon, and then the "Help" menu is displayed on the screen.
2. Press the **Content** menu key or tap the "Content" menu item, then the help information is displayed on the screen, as shown in *Figure 9.1*. The help interface mainly consists of two sections. The left section lists "Help Options", and the right section is the "Help Display Area".



**Figure 9.1 Help Information**

After opening the help interface, you can get its help information in the "Help Display Area" through the following three methods:

### Method 1:

For the key operation, you can directly press the front-panel keys (except the Power key,  key, and the  key) to obtain the help information. For the knob operation, you can rotate the knob or press down the knob to get the help information (except the multifunction knob , **Wave Vertical**  **POSITION**, and **Wave Vertical**  **SCALE**). As the function of rotating the knob is different from that of pressing down the knob, these two operations will give you different help information.





### Method 2:

In the "Help Options", rotate the multifunction knob  to switch among the help options to get the corresponding help information.

### Method 3:

Enable the touch screen and tap the desired help option to get the corresponding help information.

### TIP



- Help information for other keys and buttons:
  - Power key: powers on/off the instrument.
  -  key: displays or hides menus. Pressing this key can hide the menus.
  -  key: returns to the previous menu or last set function menu.
  - Multifunction knob : In non-menu-operation mode, rotate this knob to adjust the brightness of waveform display. When you operate on the menu, the backlight of the knob is illuminated. For the menu item that has multiple parameters under it, when you press the menu softkey, rotate the knob to select the parameter item, then press down the knob to select it (sometimes, the specified parameter item can be selected by rotating the knob). The knob can also be used to modify parameters, input the filename, etc.
  - **Wave Vertical**  **POSITION**: Rotate the knob to adjust the vertical position of the current digital channel waveform, the vertical position of the math operation waveform, the vertical position of the reference waveform, or the vertical display position of the bus decoding.
  - **Wave Vertical**  **SCALE**: Rotate the knob to adjust the vertical scale of math operation waveform or the vertical scale of the reference waveform, and also can adjust the size of the displayed digital channel waveforms.
- If the menu item is grayed out, you cannot press the corresponding front-panel menu key to obtain the help information. What you can do is only to follow the above Method 2 or 3 to get the help information.





## 10 Parameter Setting Method

You can use the knob or enable the touch screen to set the parameters of MSO8000A series. The common parameter setting methods are as follows:

### Method 1:

For the parameters with the sign , rotate the multifunction knob  on the front panel directly to select the parameter item or modify the parameter value.

### Method 2:

For the parameters with the sign , rotate the multifunction knob  on the front panel and then press it down to select the parameter item or modify the parameter value.

### Method 3:





For the parameters with  displayed on the menu, rotate the multifunction knob  on the front panel directly to set the parameter, or press down the multifunction knob  or the specified menu softkey, and then the numeric keypad is shown in *Figure 10.1* below.



Figure 10.1 Numeric Keypad

In the numeric keypad, rotate the multifunction knob  to select the parameter, then press down the knob to select it. Then input the value or the unit. You can also enable the touch screen and tap the value or unit in the numeric keypad to input them. After you input all the values and select the desired units, the numeric keypad is turned off automatically. This indicates that you have completed parameter setting. Besides, after you have input the values, you can also press OK directly to confirm the input and close the numeric keypad. At this time, the unit of the parameter is the default unit. In the numeric keypad, you can also perform the following operations:

- Delete the parameter value that has been input.
- Set the parameter to a maximum or minimum value (sometimes, the maximum or minimum value are the specified one for the current state).
- Set the parameter to a default value.
- Clear the parameter input field.

**Method 4:**

For the parameters without the above signs, press the desired menu softkey to switch between the parameter items. This method is applicable to the parameters with only two available options.

**TIP**

The above method is commonly used for the parameter settings of the oscilloscope. For other methods of parameter settings, refer to details in User Guide of this instrument.



# 11 Fuse Replacement

If you need to replace the fuse, please use the specified fuse (AC 250 V, T3.15 A; 5.2 mm × 20 mm) and perform the following operations (as shown in *Figure 11.1*):

1. Turn off the instrument, cut off the power, and remove the power cord.
2. Use a small straight slotted screwdriver to pry out the fuse holder.
3. Take out the fuse holder.
4. Replace the old fuse with a specified fuse.
5. Install the fuse holder.

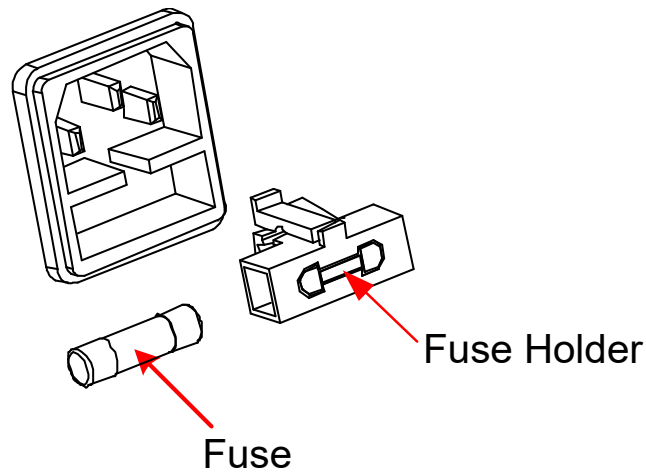

Figure 11.1 Fuse Replacement



## WARNING

To avoid electric shock, please ensure that the instrument has been turned off, the power source has been cut off, and the fuse to be used conforms to the fuse rating.

## 12 Remote Control

---

MSO8000A series digital oscilloscope can be connected to the PC via the USB, LAN, or GPIB interface to set up communication and realize remote control through the PC. The remote control can be realized by using SCPI (Standard Commands for Programmable Instruments) commands. MSO8000A series digital oscilloscope supports four ways of remote control: user-defined programming, PC software (e.g. RIGOL Ultra Sigma), VNC control, and Web Control.

## 13 More Product Information

---

### 1. Obtain the device information

Press  > **System** > **About** to obtain the information of the instrument, such as the manufacturer, model, serial number, firmware version number, and hardware version number. You can also open the "Help" menu. Then press **About** to obtain the device information.

### 2. View the option information and install the option

The instrument is installed with the trial versions of the options before leaving factory. The trial time starts from the time when you power on the instrument for the first time, and the trial time is about 2,160 minutes. Open the "Help" menu, and then press **Option list** to view the options currently installed on the oscilloscope and their information. Press **Option install** to input the serial number of the option that you've purchased. For details, refer to descriptions in User Guide.

For more information about this instrument, refer to the relevant manuals by logging in to the official website of RIGOL (<http://www.rigol.com>).

*MSO8000A User Guide* introduces the functions of the instrument and the operation methods, remote control methods, possible failures and solutions in using the instrument, the technical specifications, and order information;

*MSO8000A Programming Guide* provides detailed descriptions of SCPI commands and programming examples of the instrument.

*MSO8000A Datasheet* provides the main features and technical specifications of the instrument.

#### HEADQUARTER

**RIGOL TECHNOLOGIES CO., LTD.**  
No.8 Keling Road, New District, Suzhou,  
JiangSu, P.R.China  
Tel: +86-400620002  
Email: info@rigol.com

#### EUROPE

**RIGOL TECHNOLOGIES EU GmbH**  
Carl-Benz-Str.11  
82205 Gilching  
Germany  
Tel: +49(0)8105-27292-0  
Email: info-europe@rigol.com

#### NORTH AMERICA

**RIGOL TECHNOLOGIES, USA INC.**  
10220 SW Nimbus Ave.  
Suite K-7  
Portland, OR 97223  
Tel: +1-877-4-**RIGOL**-1  
Fax: +1-877-4-**RIGOL**-1  
Email: info@rigol.com

#### JAPAN

**RIGOL JAPAN CO., LTD.**  
5F,3-45-6,Minamiotsuka,  
Toshima-Ku,  
Tokyo,170-0005,Japan  
Tel: +81-3-6262-8932  
Fax: +81-3-6262-8933  
Email: info-japan@rigol.com

---

**RIGOL®** is the trademark of **RIGOL TECHNOLOGIES CO., LTD.** Product information in this document is subject to update without notice. For the latest information about **RIGOL's** products, applications and services, please contact local **RIGOL** channel partners or access **RIGOL** official website: [www.rigol.com](http://www.rigol.com)