

RIGOL

Quick Guide

English

DP700 Series Programmable Linear DC Power Supply

Mar. 2016

RIGOL TECHNOLOGIES, INC.

Guaranty and Declaration

Copyright

© 2016 **RIGOL** TECHNOLOGIES, INC. All Rights Reserved.

Trademark Information

RIGOL is a registered trademark of **RIGOL** TECHNOLOGIES, INC.

Publication Number

QGH05101-1110

Notices

- **RIGOL** products are covered by P.R.C. and foreign patents, issued and pending.
- **RIGOL** reserves the right to modify or change parts of or all the specifications and pricing policies at the company's sole decision.
- Information in this publication replaces all previously released materials.
- Information in this publication is subject to change without notice.
- **RIGOL** shall not be liable for either incidental or consequential losses in connection with the furnishing, use, or performance of this manual, as well as any information contained.
- Any part of this document is forbidden to be copied, photocopied, or rearranged without prior written approval of **RIGOL**.

Product Certification

RIGOL guarantees that this product conforms to the national and industrial standards in China as well as the ISO9001:2008 standard and the ISO14001:2004 standard. Other international standard conformance certifications are in progress.

Contact Us

If you have any problem or requirement when using our products or this manual, please contact **RIGOL**.

E-mail: service@rigol.com

Website: www.rigol.com

General Safety Summary

1. Only the exclusive power cord designed for the instrument and authorized for use within the local country could be used.
2. Ensure that the instrument is safely grounded.
3. Observe all terminal ratings.
4. Use proper overvoltage protection.
5. Do not operate without covers.
6. Do not insert objects into the air outlet.
7. Use the proper fuse.
8. Avoid circuit or wire exposure.
9. Do not operate the instrument with suspected failures.
10. Provide adequate ventilation.
11. Do not operate in wet conditions.
12. Do not operate in an explosive atmosphere.
13. Keep instrument surfaces clean and dry.
14. Prevent electrostatic impact.
15. Handle with caution.
16. Do not use this instrument to provide power for the active load.

Safety Notices and Symbols

Safety Notices in this Manual:



WARNING

Indicates a potentially hazardous situation or practice which, if not avoided, will result in serious injury or death.



CAUTION

Indicates a potentially hazardous situation or practice which, if not avoided, could result in damage to the product or loss of important data.

Safety Terms on the Product:

DANGER It calls attention to an operation, if not correctly performed, could result in injury or hazard immediately.

WARNING It calls attention to an operation, if not correctly performed, could result in potential injury or hazard.

CAUTION It calls attention to an operation, if not correctly performed, could result in damage to the product or other devices connected to the product.

Safety Symbols on the Product:Hazardous
VoltageSafety
WarningProtective Earth
Terminal

Chassis Ground



Test Ground

Care and Cleaning

Care

Do not store or leave the instrument where it may be exposed to direct sunlight for long periods of time.

Cleaning

Clean the instrument regularly according to its operating conditions.

1. Disconnect the instrument from all power sources.
2. Clean the external surfaces of the instrument with a soft cloth dampened with mild detergent or water. When cleaning the LCD, take care to avoid scarifying it.

**CAUTION**

To avoid damage to the instrument, do not expose it to caustic liquids.

**WARNING**

To avoid short-circuit resulting from moisture or personal injuries, ensure that the instrument is completely dry before connecting it to the power supply.

Document Overview

This manual introduces some basic information that you should know when you use the DP700 series power supply for the first time. It contains the following contents: out-of-box inspection method, product overview, how to connect the instrument to the AC power, procedures for carrying out the power-on inspection and output inspection, as well as remote control overview.

Tip

For the latest version of this manual, download it from **RIGOL** official website (www.rigol.com).

Format Conventions in this Manual

Key

- (1) The key on the front panel is denoted by the format of "Key Name (Bold) + Text Box" in the manual. For example, **On/Off** denotes the "On/Off" key.
- (2) Use the screen shot to indicate the key. For example,  denotes the Power key.

Content Conventions in this Manual

DP700 series programmable linear DC power supply includes the following models. Unless otherwise specified, this manual takes DP711 as an example to illustrate DP700 series power supply and its basic operation.

Model	No. of Channels	Output Voltage/Current
DP711	1	30 V/5 A
DP712	1	50 V/3 A

General Inspection

1. **Inspect the packaging**

If the packaging has been damaged, do not dispose the damaged packaging or cushioning materials until the shipment has been checked for completeness and has passed both electrical and mechanical tests.

The consigner or carrier shall be liable for the damage to the instrument resulting from shipment. **RIGOL** would not be responsible for free maintenance/rework or replacement of the instrument.

2. **Inspect the instrument**

In case of any mechanical damage, missing parts, or failure in passing the electrical and mechanical tests, contact your **RIGOL** sales representative.

3. **Check the accessories**

Please check the accessories according to the packing lists. If the accessories are damaged or incomplete, please contact your **RIGOL** sales representative.

Product Overview

DP700 series power supply is a type of affordable programmable linear DC power supply with high performance. With superb performance specifications, pure and reliable output, and clear user interface, the DP700 series supports timing output and trigger function, and provides a remote communication interface, enabling you to meet your diversified test requirements.

For descriptions of the front panel, refer to Figure 1; for descriptions of the rear panel, refer to Figure 2; and for descriptions of the main interface (display screen), refer to Figure 3.

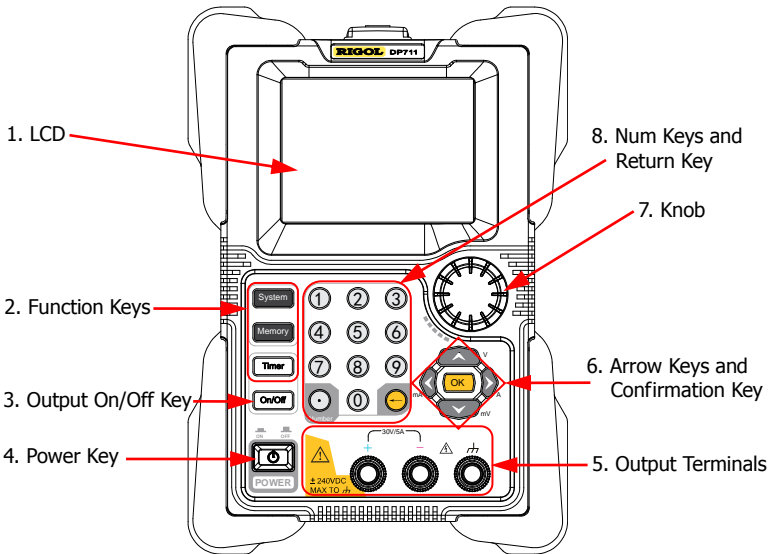

Figure 1 Front Panel

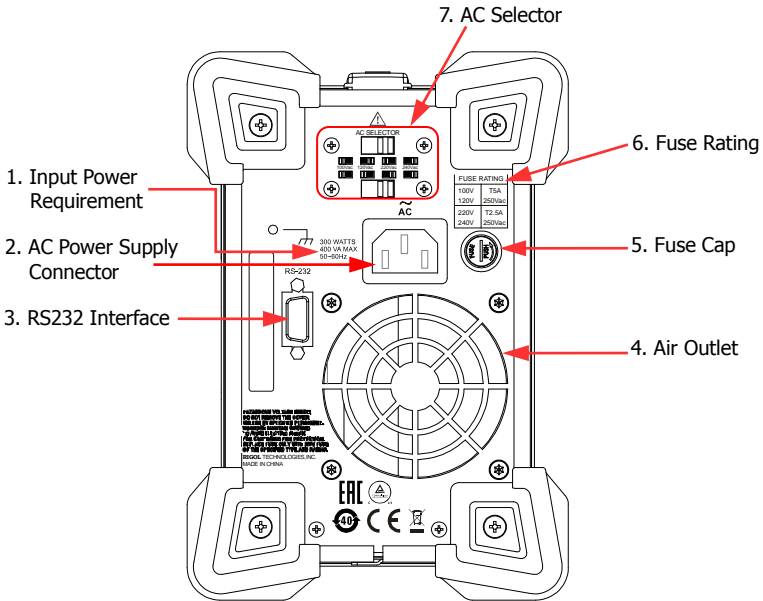

Figure 2 Rear Panel

Note: Pin 7 and Pin 8 of the RS232 interface are not used in remote communication. They are used in the trigger function (optional).

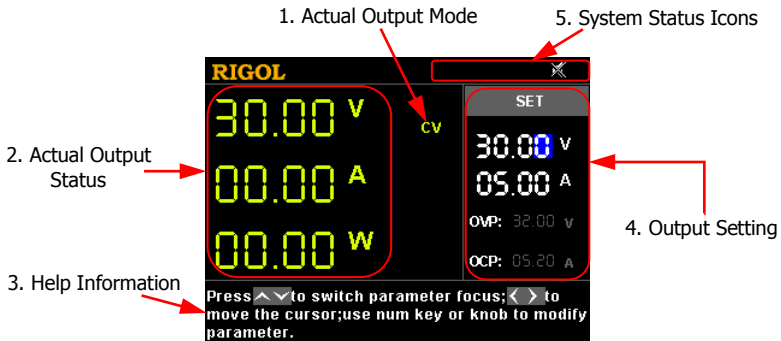

Figure 3 Main Interface

Power-on Inspection

DP700 series power supply supports various specifications of AC input power. When the DP700 series is connected with different AC power supplies, the AC selector setting on the rear panel of the instrument is different, as shown in the table below.

Table 1 AC Input Power Specification and AC Selector Setting

AC Input Power	AC Selector
100 Vac x (100% ± 10%), 50 Hz to 60 Hz	100Vac
120 Vac x (100% ± 10%), 50 Hz to 60 Hz	120Vac
120 Vac x (100% ± 10%), 50 Hz to 60 Hz	220Vac
240 Vac x (100% ± 10%) (max: 253 Vac), 50 Hz to 60 Hz	240Vac

Please strictly follow the steps below to connect the instrument to the power supply, and perform the power-on inspection and output inspection.

1. Check the input power

Ensure that the AC power to be connected to the instrument conforms to the AC input power requirement specified in Table 1.

2. Check the AC selector

Ensure that the AC selector setting on the rear panel of the instrument matches with the actual AC input power (refer to Table 1).

3. Check the fuse

When leaving the factory, the instrument has installed a fuse that conforms to the local standard. When the input voltage is 100 Vac or 120 Vac, Fuse T5A is used; when the input voltage is 220 Vac or 240 Vac, Fuse T2.5A is used.

4. Connect the AC power

Plug the specified power cord available in the accessories into the AC power supply connector of the instrument, and then connect the instrument to the properly grounded AC power.



WARNING

To avoid electric shock, ensure that the instrument is correctly grounded.

5. Power on the instrument

Press the Power key , and then the instrument is launched and begins to perform the self-inspection. If the instrument passes the self-inspection, the welcome interface is displayed; otherwise, self-inspection failure information about corresponding items (including the analog board, OVP, OCP, fan, and temperature) will be displayed.

Tip



After powering off the instrument, please wait for at least 2 s to power it on again.

6. Perform the output check

Perform the output check to ensure that the power supply can output the rated values and properly respond to the operations on the front panel.

Note: Before checking the current output, you should complete the voltage output check first.

Check the voltage output: verify the basic voltage functions without a load.

- (1) Press  to power off the instrument.
- (2) Ensure that no load is connected to the channel output terminals on the front panel. Then, press  to power on the instrument, and check whether the voltage between the positive terminal (+) and negative terminal (-) of the channel output is 0 V.
- (3) Press **On/Off** to turn on the channel output. At this time, the actual output status (actual output voltage (V), actual output current (A), and actual output power (W)) on the left section of the interface is highlighted, and the actual output mode (CV) is displayed.
 
- (4) Set the output voltage to 0 V (For setting methods, refer to the descriptions of the help information below the interface or descriptions on Page 11.), and check whether the actual output voltage displayed on the left section of the interface is approximately 0 V, the actual output current approximately 0 A. Set the output voltage to 30 V (max. rating value), and check whether the actual

output voltage is approximately 30 V, the actual output current approximately 0 A.

- (5) Press **On/Off** to turn off the channel output.

Check the current output: verify the basic current functions with a short across the power supply's output.

- (1) Connect a short across the positive terminal (+) and negative terminal (-) of the channel output with an insulated test lead (18 AWG), and then press **On/Off** to turn on the channel output. At this time, the actual output status (actual output voltage (V), actual output current (A), and actual output power (W)) on the left section of the interface is highlighted, and the actual output mode is displayed. (Note that the actual output mode is determined by the resistance of the test lead.)
- (2) Set the output voltage to 2 V (For setting methods, refer to the descriptions of the help information displayed below the interface or refer to the descriptions on Page 11.) and ensure the output mode to be CC.
- (3) Set the output current to 0 A (For setting methods, refer to the descriptions of the help information below the interface or descriptions on Page 11.), and check whether the actual output current displayed on the left section of the interface is approximately 0 A, the actual output voltage approximately 0 V. Set the output current to 5 A (max. rating value), and check whether the actual output current is approximately 5 A (the actual output voltage indicates the voltage drop arising from the test lead).
- (4) Press **On/Off** to turn off the channel output.

Setting Methods for Output Voltage/Output Current:

Method 1:

- (1) Press the Up/Down arrow key to switch the parameter focus to "Voltage Setting Value" or "Current Setting Value".
- (2) Enter a value by using the num key. While entering a value, press  to delete the unwanted character if necessary.
- (3) When setting the output voltage, press the Up arrow key or **OK** to set the voltage unit to V; or press the Down arrow key to set the voltage unit to mV. When setting the output current, press the Left arrow key to set the current unit to mA; or press the Right arrow key or **OK** to set the current unit to A.

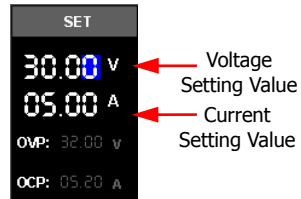





Method 2:

- (1) Press the Up/Down arrow key to switch the parameter focus to "Voltage Setting Value" or "Current Setting Value".
- (2) Press the Left/Right arrow key to move the cursor to a desired position.
- (3) Rotate the knob to modify the value.

Remote Control

DP700 series power supply can be connected to the PC via the RS232 interface to set up communication and realize remote control through the PC. The remote control can be realized by using SCPI (Standard Commands for Programmable Instruments) commands. DP700 series power supply supports two ways of remote control: user-defined programming and PC software (e.g. **RIGOL** Ultra Sigma).

When the instrument is in remote control, the  icon is displayed on the user interface. The keys on the front panel are locked (except , **On/Off**, and ). At this time, you can press  to exit the remote mode.

More Product Information

1. Obtain the device information

Press **System**, and then press the Left/Right arrow key or use the knob to select the "Info." tab. Then, you can obtain the device information, including the device model, serial number, and software version.

2. Check the option installation

Press **System**, and then press the Left/Right arrow key or use the knob to select the "Option" tab. Then, you can check the installation status of all the options.

For more information about this instrument, refer to the relevant manuals by logging in to the official website of **RIGOL** (www.rigol.com) to download them. *DP700 User's Guide*: introduces the functions of the instrument and the operation methods, remote control methods, possible failures and solutions in using the DP700 series power supply, specifications, and order information; *DP700 Programming Guide*: provides detailed descriptions of SCPI commands and programming instances of the instrument. *DP700 Datasheet*: provides the main features and technical specifications of the instrument.