

RIGOL

User's Guide

DL3000 Series Programmable DC Electronic Load

Apr. 2019

RIGOL (SUZHOU) TECHNOLOGIES INC.

Guaranty and Declaration

Copyright

© 2017 **RIGOL** TECHNOLOGIES, INC. All Rights Reserved.

Trademark Information

RIGOL is a registered trademark of **RIGOL** TECHNOLOGIES, INC.

Publication Number

UGJ01107-1110

Software Version

00.01.04

Software upgrade might change or add product features. Please acquire the latest version of the manual from **RIGOL** website or contact **RIGOL** to upgrade the software.

Notices

- **RIGOL** products are covered by P.R.C. and foreign patents, issued and pending.
- **RIGOL** reserves the right to modify or change parts of or all the specifications and pricing policies at the company's sole decision.
- Information in this publication replaces all previously released materials.
- Information in this publication is subject to change without notice.
- **RIGOL** shall not be liable for either incidental or consequential losses in connection with the furnishing, use, or performance of this manual, as well as any information contained.
- Any part of this document is forbidden to be copied, photocopied, or rearranged without prior written approval of **RIGOL**.

Product Certification

RIGOL guarantees that this product conforms to the national and industrial standards in China as well as the ISO9001:2015 standard and the ISO14001:2015 standard. Other international standard conformance certifications are in progress.

Contact Us

If you have any problem or requirement when using our products or this manual, please contact **RIGOL**.

E-mail: service@rigol.com

Website: www.rigol.com

Safety Requirement

General Safety Summary

Please review the following safety precautions carefully before putting the instrument into operation so as to avoid any personal injury or damage to the instrument and any product connected to it. To prevent potential hazards, please follow the instructions specified in this manual to use the instrument properly.

Use Proper Power Cord.

Only the exclusive power cord designed for the instrument and authorized for use within the local country could be used.

Ground the Instrument.

The instrument is grounded through the Protective Earth lead of the power cord. To avoid electric shock, connect the earth terminal of the power cord to the Protective Earth terminal before connecting any input or output terminals.

Connect the Probe Correctly.

If a probe is used, the probe ground lead must be connected to earth ground. Do not connect the ground lead to high voltage. Improper way of connection could result in dangerous voltages being present on the connectors, controls or other surfaces of the oscilloscope and probes, which will cause potential hazards for operators.

Observe All Terminal Ratings.

To avoid fire or shock hazard, observe all ratings and markers on the instrument and check your manual for more information about ratings before connecting the instrument.

Use Proper Overvoltage Protection.

Ensure that no overvoltage (such as that caused by a bolt of lightning) can reach the product. Otherwise, the operator might be exposed to the danger of an electric shock.

Do Not Operate Without Covers.

Do not operate the instrument with covers or panels removed.

Do Not Insert Objects Into the Air Outlet.

Do not insert objects into the air outlet, as doing so may cause damage to the instrument.

Use Proper Fuse.

Please use the specified fuses.

Avoid Circuit or Wire Exposure.

Do not touch exposed junctions and components when the unit is powered on.

Do Not Operate With Suspected Failures.

If you suspect that any damage may occur to the instrument, have it inspected by **RIGOL** authorized personnel before further operations. Any maintenance, adjustment or replacement especially to circuits or accessories must be performed by **RIGOL** authorized personnel.

Provide Adequate Ventilation.

Inadequate ventilation may cause an increase of temperature in the instrument, which would cause damage to the instrument. So please keep the instrument well ventilated and inspect the air outlet and the fan regularly.

Do Not Operate in Wet Conditions.

To avoid short circuit inside the instrument or electric shock, never operate the instrument in a humid environment.

Do Not Operate in an Explosive Atmosphere.

To avoid personal injuries or damage to the instrument, never operate the instrument in an explosive atmosphere.

Keep Product Surfaces Clean and Dry.

To avoid dust or moisture from affecting the performance of the instrument, keep the surfaces of the instrument clean and dry.

Prevent Electrostatic Impact.

Operate the instrument in an electrostatic discharge protective environment to avoid damage induced by static discharges. Always ground both the internal and external conductors of cables to release static before making connections.

Use the Battery Properly.

Do not expose the battery (if available) to high temperature or fire. Keep it out of the reach of children. Improper change of a battery (lithium battery) may cause an explosion. Use the **RIGOL** specified battery only.

Handle with Caution.

Please handle with care during transportation to avoid damage to keys, knobs, interfaces, and other parts on the panels.

Safety Notices and Symbols

Safety Notices in this Manual:



WARNING

Indicates a potentially hazardous situation or practice which, if not avoided, will result in serious injury or death.



CAUTION

Indicates a potentially hazardous situation or practice which, if not avoided, could result in damage to the product or loss of important data.

Safety Terms on the Product:

DANGER It calls attention to an operation, if not correctly performed, could result in injury or hazard immediately.

WARNING It calls attention to an operation, if not correctly performed, could result in potential injury or hazard.

CAUTION It calls attention to an operation, if not correctly performed, could result in damage to the product or other devices connected to the product.

Safety Symbols on the Product:



Hazardous Voltage



Safety Warning



Protective Earth Terminal



Chassis Ground



Test Ground

Care and Cleaning

Care

Do not store or leave the instrument where it may be exposed to direct sunlight for long periods of time.

Cleaning

Clean the instrument regularly according to its operating conditions.

1. Disconnect the instrument from all power sources.
2. Clean the external surfaces of the instrument with a soft cloth dampened with mild detergent or water. When cleaning the LCD, take care to avoid scarifying it.



CAUTION

To avoid damage to the instrument, do not expose it to caustic liquids.



WARNING

To avoid short-circuit resulting from moisture or personal injuries, ensure that the instrument is completely dry before connecting it to the power supply.

Environmental Considerations

The following symbol indicates that this product complies with the WEEE Directive 2002/96/EC.



Product End-of-Life Handling

The equipment may contain substances that could be harmful to the environment or human health. To avoid the release of such substances into the environment and avoid harm to human health, we recommend you to recycle this product appropriately to ensure that most materials are reused or recycled properly. Please contact your local authorities for disposal or recycling information.

You can click on the following link

http://www.rigol.com/Files/RIGOL_RoHS2.0&WEEE.pdf to download the latest version of the RoHS&WEEE certification file.

DL3000 Series Overview

DL3000 is a cost-effective programmable DC electronic load with high performance. With a user-friendly interface and superb performance specifications, DL3000 series provides various interfaces for remote communication to meet your diversified test requirements. It can be widely used in various industries, such as automotive electronics, aerospace, and fuel cells.

Main Features:

- DL3021/DL3021A: single channel, DC 150 V/40 A, total power up to 200 W
- DL3031/DL3031A: single channel, DC 150 V/60 A, total power up to 350 W
- Dynamic mode: up to 30 kHz
- Adjustable current rising speed: 0.001 A/ μ s to 5 A/ μ s
- Min. readback resolution: 0.1 mV, 0.1 mA
- 4.3-inch TFT LCD, capable of displaying multiple parameters and states simultaneously
- Overvoltage/overcurrent/overpower/overtemperature/reverse voltage protection
- 4 static modes: CC, CV, CR, CP
- 3 dynamic modes: continuous, pulsed, toggled
- List function supports editing as many as 512 steps
- Battery test function, OCP test, OPP test, factory test function, etc.
- Short-circuit test function
- Power-off memory function
- Built-in RS232/USB/LAN communication interface
- USB-GPIB interface converter (optional)

Document Overview

Chapter 1 Quick Start

This chapter introduces some basic information that you should know when you use the DL3000 series electronic load for the first time. This section contains the following contents: out-of-box inspection method, the appearance and dimensions of the instrument, descriptions of the front/rear panel, how to connect the power supply, how to carry out the turn-on checkout, how to replace the fuse, a brief introduction about the user interface, how to use the built-in help system, and how to set the parameters.

Chapter 2 Front Panel Operations

This chapter gives a detailed description about the functions of all the keys on the front panel of DL3000 series and detailed operation methods.

Chapter 3 Remote Control

This chapter introduces how to remotely control the instrument.

Chapter 4 Troubleshooting

This chapter introduces the possible failures and solutions in using the DL3000 series electronic load.

Chapter 5 Appendix

This chapter provides the order information and warranty information about the DL3000 series electronic load.

Index

This chapter provides keyword search information, enabling you to quickly locate the desired information.

Tip

For the latest version of this manual, download it from the official website of **RIGOL** (www.rigol.com).

Format Conventions in this Manual

1. Key

- (1) The key on the front panel is denoted by the format of "Key Name (Bold) + Text Box" in the manual. For example, **ON/OFF** denotes the "ON/OFF" key.
- (2) Use the screen shot to indicate the key. For example,  denotes the **Power** key.

2. Menu Softkey

The menu softkey is denoted by the format of "Menu Word (Bold) + Character

Shading". For example, **Interface** denotes the "Interface" menu softkey under **Utility**.

Content Conventions in this Manual

The number of channels and the rated values of input parameters for the DL3000 series are listed in the following table. Unless otherwise specified, this manual takes DL3031A as an example to illustrate the functions and operation methods of the DL3000 series.

Model	No. of Channels	Voltage	Current	Power
DL3021/DL3021A	1	DC 150 V	40 A	200 W
DL3031/DL3031A	1	DC 150 V	60 A	350 W

Contents

Guaranty and Declaration	I
Safety Requirement	II
General Safety Summary.....	II
Safety Notices and Symbols.....	IV
Care and Cleaning.....	V
Environmental Considerations.....	V
DL3000 Series Overview	VI
Document Overview	VII
Chapter 1 Quick Start	1-1
General Inspection	1-2
Appearance and Dimensions.....	1-3
Front Panel.....	1-4
Rear Panel.....	1-10
Turn-on Checkout.....	1-13
To Connect to Power Supply.....	1-13
To Power On the Instrument.....	1-14
Fuse Replacement	1-15
User Interface.....	1-16
To Use the Built-in Help System.....	1-17
Parameter Setting Method.....	1-18
Chapter 2 Front Panel Operations	2-1
Local/Remote Operation Mode.....	2-2
Local Operation Mode.....	2-2
Remote Operation Mode	2-2
Static Operation Mode	2-3
Constant Current (CC) Mode	2-3
Constant Voltage (CV) Mode	2-7
Constant Resistance (CR) Mode.....	2-11
Constant Power (CP) Mode	2-15
Transient Test Function	2-18
CC Continuous Mode (Con).....	2-18
CC Pulsed Mode (Pul).....	2-25
CC Toggled Mode (Tog)	2-32
List Operation Function (List).....	2-38
Application Function	2-45
OCP Test Function.....	2-45
OPP Test Function.....	2-53
Battery Test Function	2-60
Advanced Function	2-65
Factory Test Function	2-65
CC+CV Function	2-69

Waveform Display Function	2-73
Input Control	2-78
Turn On/Off the Input	2-78
Von Latch Function	2-78
Short-circuit Operation	2-79
Trigger Operation	2-80
Protection Function	2-82
Sense Working Mode	2-84
Function of Terminals on the Rear Panel	2-86
Store and Recall	2-87
Cursor	2-88
Save	2-88
Read	2-90
Delete	2-91
Copy and Paste	2-91
System Utility Function	2-92
System	2-93
Communication Interface Setting	2-97
System Info	2-105
Reset	2-105
Option Configuration	2-110
Chapter 3 Remote Control	3-1
Remote Control via USB	3-2
Remote Control via LAN	3-5
Remote Control via GPIB	3-8
Remote Control via RS232	3-11
Chapter 4 Troubleshooting	4-1
Chapter 5 Appendix	5-1
Appendix A: Order Information	5-1
Appendix B: Warranty	5-4
Index	1

Chapter 1 Quick Start

Contents in this chapter:

- General Inspection
- Appearance and Dimensions
- Front Panel
- Rear Panel
- Turn-on Checkout
- Fuse Replacement
- User Interface
- To Use the Built-in Help System
- Parameter Setting Method

General Inspection

1. Inspect the packaging

If the packaging has been damaged, do not dispose the damaged packaging or cushioning materials until the shipment has been checked for completeness and has passed both electrical and mechanical tests.

The consigner or carrier shall be liable for the damage to the instrument resulting from shipment. **RIGOL** would not be responsible for free maintenance/rework or replacement of the instrument.

2. Inspect the instrument

In case of any mechanical damage, missing parts, or failure in passing the electrical and mechanical tests, contact your **RIGOL** sales representative.

3. Check the accessories

Please check the accessories according to the packing lists. If the accessories are damaged or incomplete, please contact your **RIGOL** sales representative.

Appearance and Dimensions

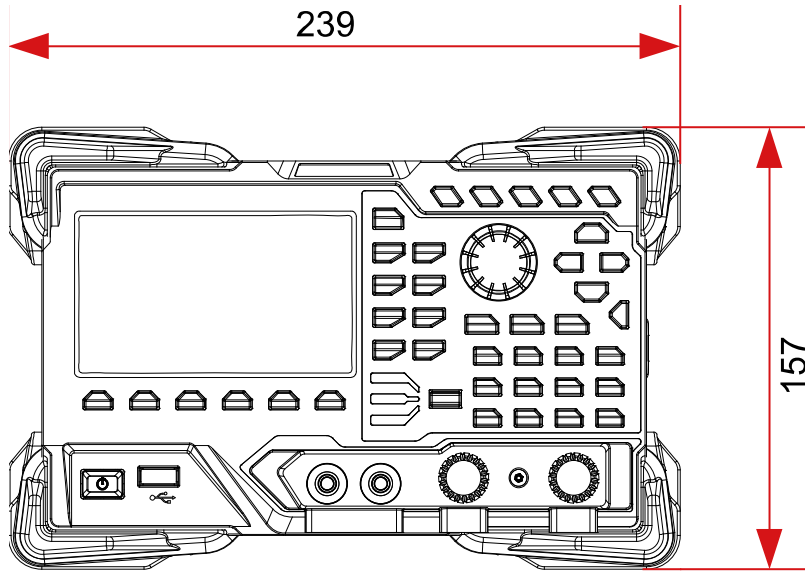

Figure 1-1 Front View

Unit: mm

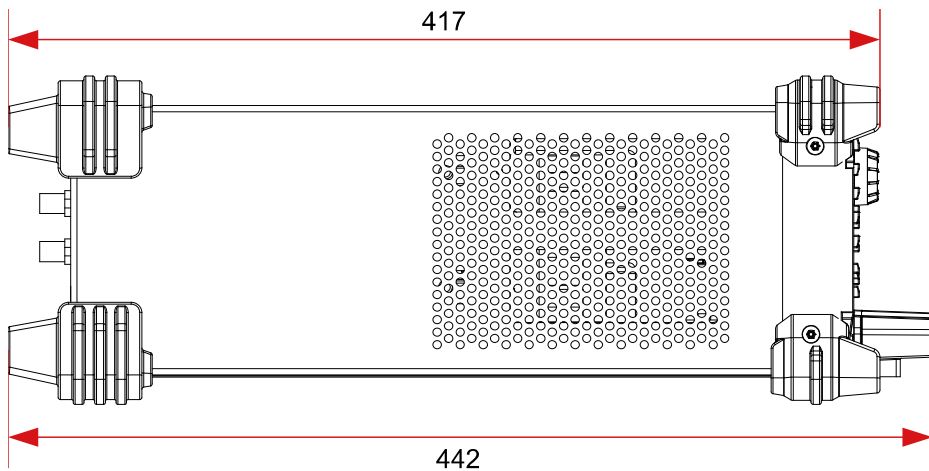

Figure 1-2 Side View

Unit: mm

Front Panel

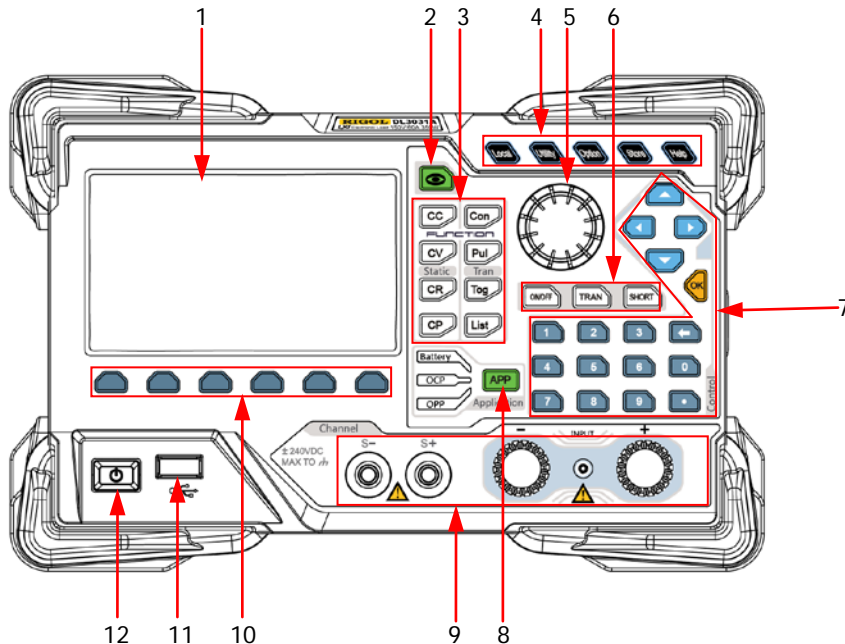

Figure 1-3 Front Panel

1. LCD

4.3-inch TFT LCD, used to display the system status, input parameters, menu setting, prompt message, etc.

2. Waveform Display Key

Pressing this key can enter the waveform display interface. You can observe the changes of parameters from the dynamic waveform.

3. Function Keys

Provide four static operating modes and three dynamic test functions. In addition, there is also a key used for list operation.

(1) CC key



Pressing this key can enter the constant current (CC) mode. You can set parameters for the mode, such as current, range, slew rate, and starting voltage.

(2) CV key



Pressing this key can enter the constant voltage (CV) mode. You can set parameters for the mode, such as voltage and range.

(3) CR key



Pressing this key can enter the constant resistance (CR) mode. You can set parameters for the mode, such as resistance and range.

(4) CP key



Pressing this key can enter the constant power (CP) mode. You can set parameters for the mode, such as power and upper limit of the voltage.

(5) Con key



Pressing this key can enter the continuous (Con) mode. You can set parameters for the mode, such as range, Level A, Level B, rising slew rate, and falling slew rate.

(6) Pul key

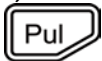

Pressing this key can enter the pulsed (Pul) mode. You can set parameters for the mode, such as range, Level A, Level B, rising slew rate, and falling slew rate.

(7) Tog key



Pressing this key can enter the toggled (Tog) mode. You can set parameters for the mode, such as range, Level A, Level B, rising slew rate, and falling slew rate.

(8) List key



Pressing this key can enter the list operation interface. You can set parameters such as mode, range, the number of times the list is cycled, and the number of steps.

4. System Function Keys

(1) Local/remote switch key



In remote operation mode, when you press this key, you can switch to the local mode.

(2) System utility function key



- System
Sets the system language, power-on value, brightness, short-circuit function, digital input/output, beeper (on/off), Sense function, log, Von Latch function, voltage monitoring output terminal, and current monitoring output terminal.
- Interface
Configures parameters for remote communication interfaces (GPIB/USB/RS232/LAN).

- **System Info**
Displays the manufacturer, device model, software and hardware versions, FPGA version, boot version, system boot times, calibration date, and product serial number.
- **Reset**
Restores the instrument settings to its factory default settings, For default settings, refer to Table 2-3.

(3) **Advanced function key**



Provides advanced functions. Currently, the factory test function and CC+CV function are supported.

(4) **Storing and recalling operation key**



Saves, reads, deletes, copies, and pastes the files. The instrument provides an internal non-volatile memory ("Disk C") and supports an external memory ("Disk D"). A maximum of 100 files can be stored in the instrument.

(5) **Help key**



Enters the built-in help system. You can view relevant help information for any key or menu key on the front panel.

5. Knob

- (1) Switch the parameters or parameter values.
- (2) Increases (rotate clockwise) or decreases (rotate counterclockwise) the value at the cursor.

Note: Rotating the knob in different interfaces can produce different operation results. Here introduces its common usage. For other specific usages and operation methods, refer to details in relevant chapters.

6. Input Control Keys

(1) **Input on/off key**



Enables or disables the sink function of the load.

(2) **Transient trigger key**



Turns on or off the transient trigger function.

(3) **Short-circuit key**



Enables or disables the short circuit function of the load.

7. Control Keys

Control keys include the arrow keys, numeric keys, and confirmation key. Pressing the control keys in different interfaces can produce different operation results.

Note: Here introduces their common usage. For their other specific usages and operation methods, refer to details in relevant chapters.

(1) Arrow keys (Up/Down/Left/Right arrow key)

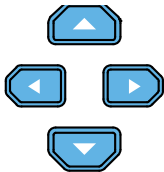

- Switch the parameter focus.
- Move the cursor.
- Switch the parameters or parameter values.
- When setting parameters, use the Up arrow key to increase the value at the cursor or use the Down arrow key to decrease the value at the cursor.

(2) Confirmation key



Confirms the parameter setting.

(3) Numeric keys and backspace key

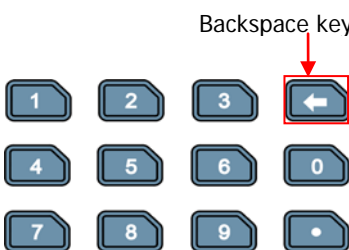

Backspace key

- Numeric keys
The numeric keys contain numbers (0-9) and a decimal point. You can use the numeric keys to enter a value for the parameter.
- Backspace key
Deletes the unwanted characters or numerical values that have been entered.

8. Application Key

Enables one of the following three application functions: OCP test, OPP test, or Battery test. You can press this key to switch among the three functions.

9. Channel Terminals

Channel terminals include the channel input terminals and Sense terminals, as shown in Figure 1-4.

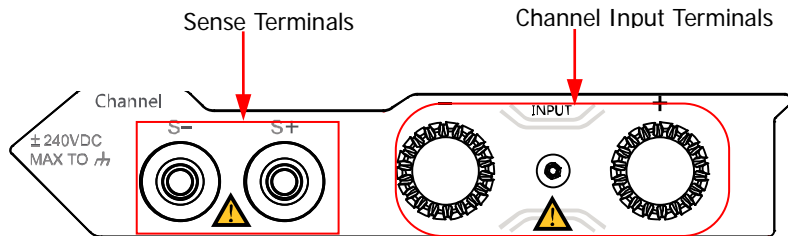

Figure 1-4 Channel Terminals

- (1) Channel input terminal: Connects with the device under test (DUT, such as battery and power supply), which is used for inputting voltage and current.

Note: Connect the positive polarity of the load to the (+) terminal of the channel output, and the negative polarity of the load to the (-) terminal of the channel output.

- (2) Sense terminal: When the DUT outputs large current, the sense terminal can be used to accurately measure the voltage across the output terminals of the DUT to compensate for the voltage drop on the load.

Connection methods for the input terminals (see Figure 1-5):

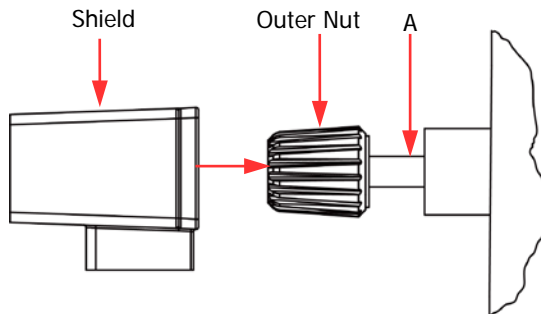

Figure 1-5 Connect Input Terminals

- a) Rotate the outer nut of the input terminal counterclockwise to remove it.
- b) Connect the test lead to Position A of the input terminal.
- c) Fasten the outer nut of the input terminal clockwise.
- d) Secure the shield to the terminal and then tighten the screw.



CAUTION

To avoid electric shock, ensure that you have installed the shield when the DC voltage output from the DUT is equal to or greater than 70 V.

10. Menu Keys

You can press the specified menu key to execute the corresponding operation displayed at the bottom of the interface on the screen.

11. USB Host

- (1) The instrument is regarded as the "master device". You can use the data line to connect it to the USB storage device (e.g. U-disk) to realize external storage or recalling.

- (2) Use the USB-GPIB interface converter to extend the GPIB interface for the load, and then use the GPIB cable to connect the load to the PC to realize remote control.

12. Power Key

Turn on or off the instrument.

Rear Panel

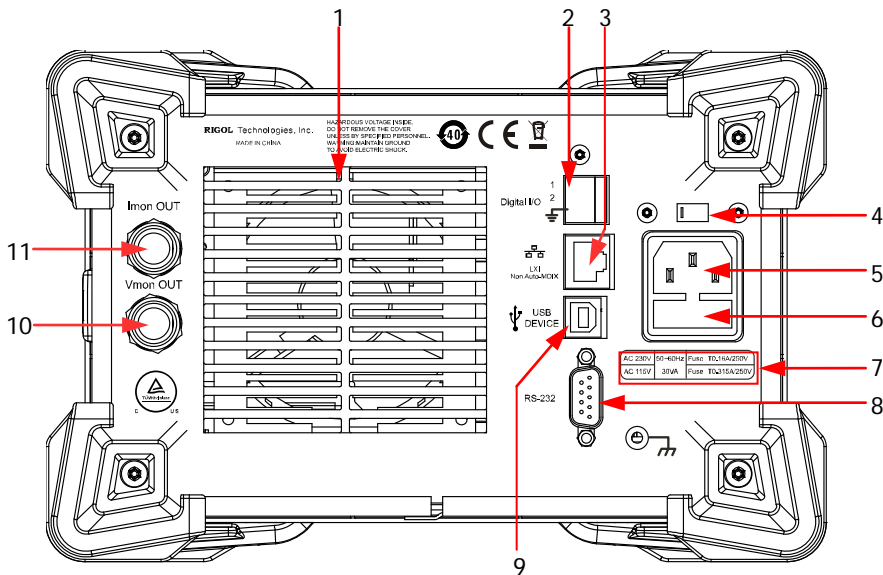

Figure 1-6 Rear Panel

1. Air Outlet

Decrease the temperature inside the instrument to ensure its performance. When you place the instrument on the workbench or install it into the rack, keep the air outlet from a distance of 10 cm to ensure adequate ventilation.

2. Digital I/O

The digital I/O interface supports the digital input (Terminal 1, input voltage 3.3 V or 5 V) and output (Terminal 2, output voltage 3.3 V).

Note: This function is a standard configuration for DL3031A/DL3021A, and it is an option for DL3031/DL3021. Therefore, for the DL3031/DL3021 model, you need to purchase the digital I/O option (with the order No. DIGITALIO-DL3).

3. LAN Interface

LAN interface is of the Non-Auto-MDIX type. The instrument can be connected to the Local Area Network (LAN) via the interface, so that you can realize remote control for the instrument. The instrument is in compliance with the standards specified in LXI Device Specification 2011. It can be used to set up a test system with other standard devices to easily realize the system integration.

4. AC Selector

Selects the voltage that matches with the actual AC input power. For details,

refer to "Fuse Rating" on the rear panel or Table 1-2.

The electronic load supports two AC voltage ratings: 115 V and 230 V. Please select the proper voltage scale based on the AC rating in your country.

When the switch lever is located at a different position, it indicates that a different voltage rating is selected. When the switch lever is at the left, it indicates that 230 V is selected. When the switch lever is at the right, it indicates that 115 V is selected.

5. AC Power Cord Connector

AC power input interface. Plug the specified power cord available in the accessories into the AC power cord connector of the instrument, and then connect the instrument to the AC power.



CAUTION

Before connecting the AC power, please select the proper voltage scale by using the AC selector.

6. Fuse

When leaving the factory, the instrument has installed a fuse that conforms to the local standard. For fuse replacement, refer to "**Fuse Replacement**".



CAUTION

To avoid electric shock or fire disaster, please use the specified fuse and ensure that no short circuit occurs to the fuse holder.

7. Fuse Rating

The required fuse rating is related to the actual input voltage, please refer to the "fuse rating" on the rear panel of the load or refer to Table 1-2.

8. RS232 Interface

Serial communication interface. Use the 9-pin RS232 cable to build communication with the PC to realize remote control.

9. USB Device

The instrument can be regarded as the "standby device" to connect to the external USB device (e.g. PC) to realize remote control.

10. Voltage Monitoring Output Terminal

The voltage monitoring output terminal outputs the signal in analog quantity. You can connect a device such as a digital oscilloscope through the terminal to display the voltage output from the output terminal, so as to monitor the changes of input voltage of the load.

11. Current Monitoring Output Terminal

The current monitoring output terminal outputs the signal in analog quantity. You can connect a device such as a digital oscilloscope through the terminal to display the current output from the output terminal, so as to monitor the changes of input current of the load.

Turn-on Checkout

To Connect to Power Supply

Two kinds of AC power inputs are supported by the DL3000 series. When it is connected to different power sources, the AC selector setting on its rear panel is different, as shown in Table 1-1.

Table 1-1 AC Input Power Specification and AC Selector Setting

AC Input Power	AC Selector
$\pm(10\%$ of AC input + 115 Vac), 50 Hz to 60 Hz	115
$\pm(10\%$ of AC input + 230 Vac) (max: 250 Vac), 50 Hz to 60 Hz	230

Please strictly follow the steps below to connect the DL3000 electronic load to the power supply.

1. Check the input power

Ensure that the AC power to be connected to the load conforms to the AC input power requirement specified in Table 1-1.

2. Check the AC selector

Ensure that the AC selector setting (115 V or 230 V) on the rear panel of the load matches the actual AC input power (For the match relationship, refer to Table 1-1).

3. Check the fuse

When leaving the factory, the load has installed a fuse that conforms to the destination country standard. Please refer to the "fuse rating" on the rear panel of the load or refer to Table 1-2 to ensure that the fuse matches the actual AC input power.

4. Connect the AC power

Plug the specified power cord available in the accessories into the AC power supply connector of the instrument, and then connect the instrument to the properly grounded AC power.



WARNING

To avoid electric shock, ensure that the instrument is correctly grounded.

To Power On the Instrument

After the instrument is connected to the power source, press the **Power** key  at the left bottom of the front panel to power on the instrument. When the instrument is turned on, it will undergo a self-test. If the instrument passes the self-test, the welcome interface is displayed; otherwise, self-test failure information will be displayed. At this time, please contact **RIGOL** distributors.



CAUTION

Ensure that the AC selector setting on the rear panel of the instrument matches the actual AC input voltage, otherwise, the electronic load will be burned out.



CAUTION

After starting the instrument, please connect the cable properly, and then enable the input of the electronic load. Otherwise, the instrument or the device under test (DUT) will be damaged.



CAUTION

Please pay attention to the positive and negative polarities of the electronic load to avoid wrong connection. Otherwise, the load will be burned out.

Tip

After powering off the electronic load, please wait for at least 1 s before you power it on again.

Fuse Replacement

The fuse specification is related to the actual input voltage, as shown in Table 1-2.

Table 1-2 Fuse Rating

Input Voltage	Fuse Rating
115 Vac	T0.315 A/250 V
230 Vac	T0.20 A/250 V

When leaving the factory, the instrument has installed a fuse that conforms to the local standard. If the fuse is required to be replaced, select a fuse that matches the actual input voltage and perform the following steps.

1. Turn off the instrument, and then disconnect the instrument from the power source. Remove the power cord.
2. Insert a slotted screwdriver into the slot of the fuse holder to pry it out, as shown in Figure 1-7.

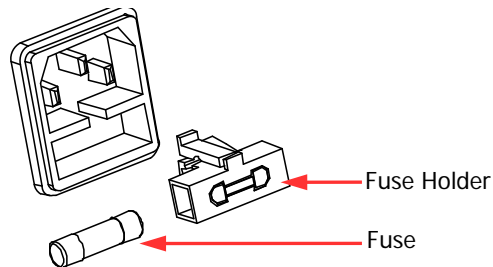

Figure 1-7 Fuse Replacement

3. Take out the fuse and replace it according to the fuse rating (refer to the "Fuse Rating" on the rear panel of the instrument or Table 1-2).
4. Mount the fuse holder (pay attention to its direction when mounting it).



WARNING

To avoid personal injuries, turn off the instrument and cut off the power supply before replacing the fuse; to avoid electric shock or fire disaster, before connecting to the AC power, select the voltage specification that matches the actual input voltage and replace a proper fuse that conforms to the voltage specification.

User Interface

The user interface of the DL3000 series consists of main interface, guide interface, and function interface. In the main interface, you can set and view the information about the channel input; in the guide interface, you can directly set the parameters according to the guide diagram and view the parameter information; in the function interface (including the waveform interface), you can set and view the information about the functions. When the instrument powers on, it enters the main interface by default. This section mainly introduces the main interface of the electronic load. The guide interface and function interface will be introduced in "**Front Panel Operations**".

The main interface is shown in Figure 1-8. For the descriptions of the main interface, refer to Table 1-3.

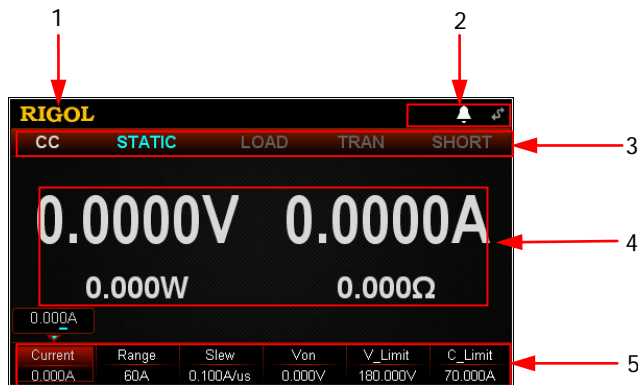

Figure 1-8 Main Interface

Table 1-3 Main Interface Description

No.	Name	Description
1	RIGOL	Company Logo
2	System Status Icon	<ul style="list-style-type: none"> : indicates that the overtemperature protection occurs. : indicates that the USB device is recognized. : indicates that the network is connected. : indicates that GPIB is connected. : indicates that the beeper is off. : indicates that the beeper is on. : indicates that the instrument is remotely controlled.
3	Function State	Displays the function state of the load in a real-time manner.
4	Actual Input Value	Displays the actual input voltage, sink current, etc.
5	Menu Item	Displays the function menu. Press the specified key below to select the specified menu item.

To Use the Built-in Help System

The built-in help system provides help information for any key on the front panel (except parameter input area) and menu keys, which are convenient for you to get the descriptions of the function keys or menus, as shown in Figure 1-9.

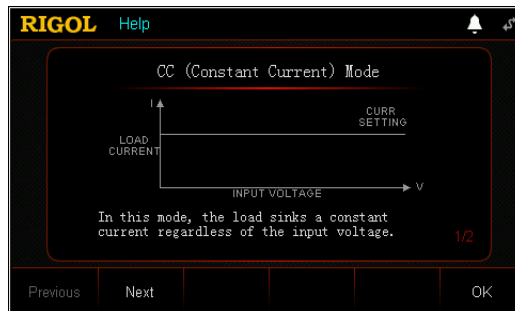



Figure 1-9 Help Information Interface

1. Get the built-in help information
Press **Help**, and then "Help" will be displayed at the top of the interface, being highlighted. At this time, press the corresponding function key or menu key to enter the corresponding help information interface.
2. Page up/down operation
If the help information is displayed in several pages, press **Previous** to go to the previous page or press **Next** to go to the next page. You can also use the arrow keys or the knob to page up/down the help information.
3. Exit the current help information interface
When the help information is displayed, press **OK** to exit the current help information interface and return to the previous interface.

Parameter Setting Method

Most parameters can be set by operating the keys on the front panel. The common setting methods are listed below. The setting method for certain parameters is different from the methods below, refer to the relevant chapters of this manual for the further explanation.

Method 1: Use the numeric keys

1. In the main interface, press the specified menu key to switch the parameter focus; in the guide interface, use the arrow keys to switch the parameter focus.
2. Enter a value by using the numeric key. While entering a name, press  to delete the unwanted character if necessary.
3. When setting resistance, press the specified menu key and select "Ω" or "kΩ" to be the unit.
When setting period/width, press the specified menu key and select "ms" or "s" to be the unit.
When setting frequency, press the specified menu key and select "Hz" or "kHz" to be the unit.
When setting other parameters, press  to confirm the input.

Method 2: Use the knob or the arrow keys

1. In the main interface, press the specified menu key to switch the parameter focus.
2. Press the Left/Right arrow key to move the cursor to a desired position.
3. Press the Up/Down arrow key or rotate the knob to modify the value.

Chapter 2 Front Panel Operations

Contents in this chapter:

- Local/Remote Operation Mode
- Static Operation Mode
- Transient Test Function
- List Operation Function (List)
- Application Function
- Advanced Function
- Waveform Display Function
- Input Control
- Protection Function
- Sense Working Mode
- Function of Terminals on the Rear Panel
- Store and Recall
- System Utility Function

Local/Remote Operation Mode

The load provides two operation modes: local and remote.

Local Operation Mode

After you power on the instrument, it enters the local operation mode by default. In the local operation mode, all the keys on the front panel are available for you to use.

Remote Operation Mode

In the remote operation mode, you can send the programming commands from the PC via any one of the interfaces (GPIB, USB, RS232, or LAN).

In remote operation mode, all the keys (except the **Power** key  and the **Local** key) were disabled. You can only control the load by programming commands. To return to the local operation mode, press **Local** on the front panel.

Tip

Factory test mode and APP functions (OCP/OPP) do not support remote operation.

Static Operation Mode

The static operation modes include the following 4 modes:

- Constant Current (CC) Mode
- Constant Voltage (CV) Mode
- Constant Resistance (CR) Mode
- Constant Power (CP) Mode

Constant Current (CC) Mode

In CC mode, the electronic load will sink a current in accordance with the programmed value regardless of the input voltage, as shown in Figure 2-1.

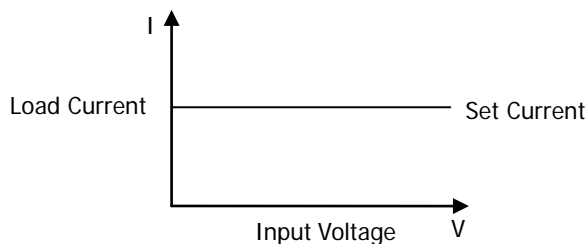

Figure 2-1 Constant Current (CC) Mode

Operation Procedures:

1. Power on the instrument

Press the **Power** key  on the front panel to power on the instrument.

2. Connect the DUT and the channel input terminals of the load

Connect the DUT and the channel input terminals on the front panel of the load as shown in Figure 2-2.

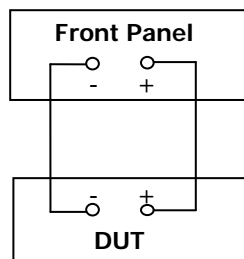

Figure 2-2 Connect to the Terminals

**CAUTION**

While making a connection, the positive polarity of the load should be connected to the (+) terminal of the channel output, and the negative polarity of the load to the (-) terminal of the channel output. A misconnection with the terminals may cause damage to the instrument or the DUT.

3. Set channel parameters

Press **CC** to enter the main interface of CC mode, as shown in Figure 2-3. At the top of the main interface, "CC" and "STATIC" are active. Of which, "STATIC" is highlighted.

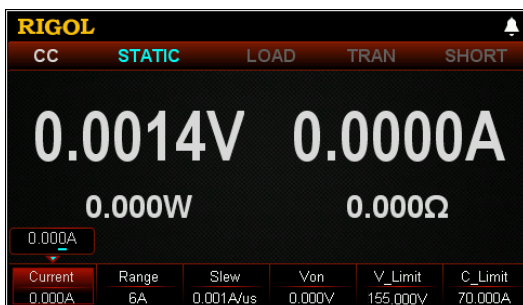

Figure 2-3 Main Interface of CC Mode

In CC mode, you need to set the following parameters: Current, Range, Slew, Von, V_Limit, C_Limit.

Set Current

The constant current value in CC mode. The default unit for the current is A.

- (1) In the main interface, press **Current** to switch the parameter focus to "Current".
- (2) Enter a value by using the numeric keys, arrow keys, or the knob. For setting methods, refer to the descriptions of the help information or refer to the descriptions in "**Parameter Setting Method**".

Tip

In CC mode, when the set load current is greater than the current output from the DUT, short circuit occurs to the DUT.

Set Range

The working ranges of current in CC mode are as follows. Different models have different ranges.

DL3021/DL3021A: low range (0 to 4 A); high range (0 to 40 A)

DL3031/DL3031A: low range (0 to 6 A); high range (0 to 60 A)

- (1) In the main interface, press **Range** to switch the parameter focus to "Range".

- (2) Press **Range** to switch the current working range. You can also use the Left/Right arrow key or the knob to switch it.

Note:

- The low range provides better resolution and accuracy at low current settings.
- If the set current value is greater than the maximum value of the low range, you must select a high range.

**CAUTION**

Before switching the current range, please disable the channel input to avoid causing damage to the instrument or the DUT.

Set Slew

The current slew rate for the positive transitions in CC mode. The slew rate refers to the rate at which the input current to a module changes to a new programmed value. The default unit for the slew rate is A/ μ s.

- (1) In the main interface, press **Slew** to switch the parameter focus to "Slew".
- (2) Enter a value by using the numeric keys, arrow keys, or the knob. For setting methods, refer to the descriptions of the help information or refer to the descriptions in "**Parameter Setting Method**".

Tip

The range of the slew rate is determined by the current ratio (from 10% to 90%; from 90% to 10%) changes.

Set Von

When the input voltage is greater than the set starting voltage (V_{on}), the load starts to sink the current. The default unit for V_{on} is V, and it ranges from 0 V to 150 V. The default V_{on} is 0 V. To enable or disable this function, refer to descriptions in "**Enable/Disable the Von Latch Function**".

- (1) In the main interface, press **Von** to switch the parameter focus to "Von".
- (2) Enter a value by using the numeric keys, arrow keys, or the knob. For setting methods, refer to the descriptions of the help information or refer to the descriptions in "**Parameter Setting Method**".

Set V_Limit

The upper limit of the voltage working in CC mode. The default unit for V_{Limit} is V, and it ranges from 0 V to 155 V.

- (1) In the main interface, press **V_Limit** to switch the parameter focus to "V_Limit".
- (2) Enter a value by using the numeric keys, arrow keys, or the knob. For setting methods, refer to the descriptions of the help information or refer to the descriptions in "**Parameter Setting Method**".

Set C_Limit

The upper limit of the current working in CC mode. The default unit for C_Limit is A, and it ranges from 0 A to 70 A.

- (1) In the main interface, press **C_Limit** to switch the parameter focus to "C_Limit".
- (2) Enter a value by using the numeric keys, arrow keys, or the knob. For setting methods, refer to the descriptions of the help information or refer to the descriptions in "**Parameter Setting Method**".

4. Turn on the channel input

Press **On/Off** to turn on the channel input. At this time, the actual input voltage, current, resistance, and power will be displayed in the main interface.

Note: Once the channel input is turned on, the load will not start to sink the current until the input voltage is greater than the starting voltage.



WARNING



To avoid electric shock, ensure that the DUT is connected to the input terminals of the load properly before you turn on the channel input.



CAUTION

When the fan stops working, the channel is disabled. Then, a message is displayed, "Fan stops running!"

5. View waveform display

Press the **waveform display key**  to enter the waveform display interface, as shown in Figure 2-4. By default, the current waveform is displayed. When the input voltage changes, the load will sink a constant current. For detailed operations, refer to the descriptions in "**Waveform Display Function**" section. Press the **waveform display key**  again to exit the waveform display interface and return to the main interface of CC mode.

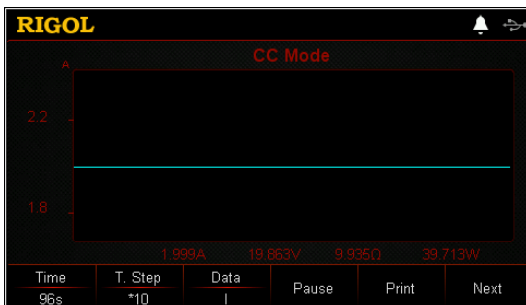

Figure 2-4 Waveform Display Interface of CC Mode

6. Exit CC mode

Press any key on the front panel of the load to exit CC mode.

Constant Voltage (CV) Mode

In CV mode, the load will sink enough current to control the input voltage to the set value. The load acts as a shunt voltage regulator when operating in CV mode, as shown in Figure 2-5.

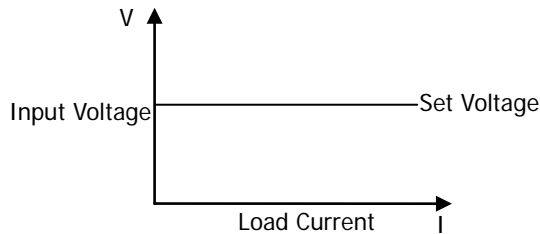

Figure 2-5 Constant Voltage (CV) Mode

Operation Procedures:

1. Power on the instrument

Press the **Power** key  on the front panel to power on the instrument.

2. Connect the DUT and the channel input terminals of the load

Connect the DUT and the channel input terminals on the front panel of the load as shown in Figure 2-2.



CAUTION

While making a connection, the positive polarity of the load should be connected to the (+) terminal of the channel output, and the negative polarity of the load to the (-) terminal of the channel output. A misconnection with the terminals may cause damage to the instrument or the DUT.

3. Set channel parameters

Press **CV** to enter the main interface of CV mode, as shown in Figure 2-6. At the top of the main interface, "CV" and "STATIC" are active. Of which, "STATIC" is highlighted.



Figure 2-6 Main Interface of CV Mode

In CV mode, you need to set the following parameters: Voltage, Range, V_Limit, C_Limit.

Set Voltage

The constant voltage value in CV mode. The default unit for the voltage is V.

- (1) In the main interface, press **Voltage** to switch the parameter focus to "Voltage".
- (2) Enter a value by using the numeric keys, arrow keys, or the knob. For the setting methods, refer to the descriptions of the built-in help information or refer to the descriptions in "**Parameter Setting Method**".

Tip

In CV mode, when the set load voltage is greater than the voltage output from the DUT, broken circuit occurs to the DUT.

Set Range

Working range for the voltage in CV mode. Two ranges are available: low range (0-15 V) and high range (0-150 V).

- (1) In the main interface, press **Range** to switch the parameter focus to "Range".
- (2) Press **Range** to switch the voltage working range. You can also use the Left/Right arrow key or the knob to switch it.

Note:

- The low range provides better resolution and accuracy at low voltage settings.
- If the set voltage value is greater than the maximum value of the low range, you must select a high range.



CAUTION

Before switching the voltage range, please disable the channel input to avoid causing damage to the instrument or the DUT.

Set V_Limit

The upper limit of the voltage working in CV mode. The default unit for V_Limit is V, and it ranges from 0 V to 155 V.

- (1) In the main interface, press **V_Limit** to switch the parameter focus to "V_Limit".
- (2) Enter a value by using the numeric keys, arrow keys, or the knob. For the setting methods, refer to the descriptions of the built-in help information or refer to the descriptions in "**Parameter Setting Method**".

Set C_Limit

The upper limit of the current working in CV mode. The default unit for C_Limit is A, and it ranges from 0 A to 70 A.

- (1) In the main interface, press **C_Limit** to switch the parameter focus to "C_Limit".
- (2) Enter a value by using the numeric keys, arrow keys, or the knob. For setting methods, refer to the descriptions of the help information or refer to the descriptions in "**Parameter Setting Method**".

4. Turn on the channel input

Press **On/Off** to turn on the channel input. At this time, the actual input voltage, current, resistance, and power will be displayed in the main interface.



WARNING



To avoid electric shock, ensure that the DUT is connected to the input terminals of the load properly before you turn on the channel input.



CAUTION

When the fan stops working, the channel is disabled. Then, a message is displayed, "Fan stops running!"

5. View waveform display

Press the **waveform display key**  to enter the waveform display interface, as shown in Figure 2-7. When you select "U" under "Data", you can view the voltage waveform. When changes occur to the current, the input voltage remains to be the set voltage, unchanged. For detailed operations, refer to the descriptions in "**Waveform Display Function**" section. Press the **waveform display key**  again to exit the waveform display interface and return to the main interface of CV mode.

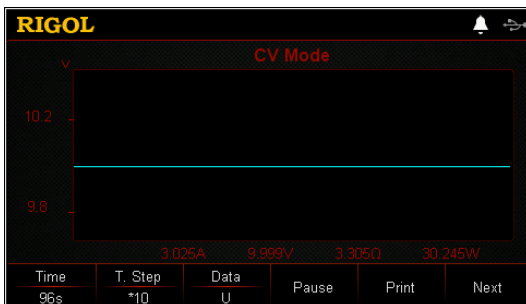

Figure 2-7 Waveform Display Interface of CV Mode

6. Exit CV mode

Press any key on the front panel of the load to exit CV mode.

Constant Resistance (CR) Mode

In CR mode, the load is regarded as a constant resistance, and changes the current linearly proportional to the input voltage, as shown in Figure 2-8.

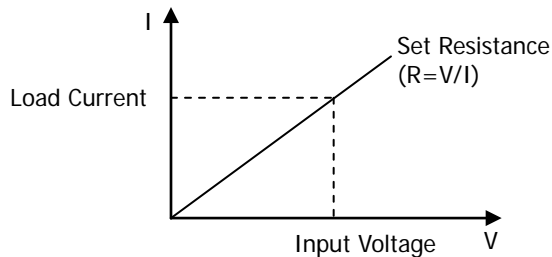

Figure 2-8 Constant Resistance (CR) Mode

Note: When in CR mode, please ensure that the input device works in the constant voltage mode.

Operation Procedures:

1. Power on the instrument

Press the **Power** key  on the front panel to power on the instrument.

2. Connect the DUT and the channel input terminals of the load

Connect the DUT and the channel input terminals on the front panel of the load as shown in Figure 2-2.



CAUTION

While making a connection, the positive polarity of the load should be connected to the (+) terminal of the channel output, and the negative polarity of the load to the (-) terminal of the channel output. A misconnection with the terminals may cause damage to the instrument or the DUT.

3. Set channel parameters

Press **CR** to enter the main interface of CR mode, as shown in Figure 2-9. At the top of the main interface, "CR" and "STATIC" are active. Of which, "STATIC" is highlighted.

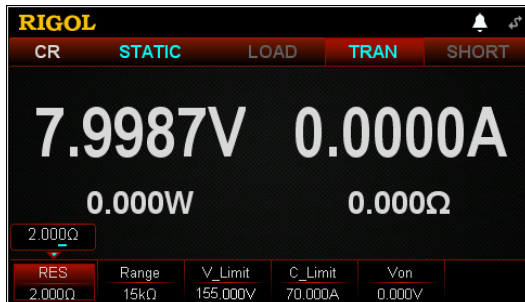

Figure 2-9 Main Interface of CR Mode

In CR mode, you need to set the following parameters: RES, Range, V_Limit, C_Limit.

Set RES

The constant resistance value in CR mode. The resistance unit is: Ω or k Ω .

- (1) In the main interface, press **RES** to switch the parameter focus to "RES".
- (2) Enter a value by using the numeric keys, arrow keys, or the knob. For setting methods, refer to the descriptions of the help information or refer to the descriptions in "**Parameter Setting Method**".

Note: When the loop current is greater than 15 mA, the resistance set in CR mode stays stable and the accuracy is good. When the loop current is smaller than 15 mA, the accuracy becomes poor. Moreover, the smaller the loop current, the poorer the accuracy.

Set Range

Working range for the resistance in CR mode. Two resistance ranges are available: low range (0.08 Ω to 15 Ω); high range (2 Ω to 15 k Ω)

- (1) In the main interface, press **Range** to switch the parameter focus to "Range".
- (2) Press **Range** to switch the resistance working range. You can also use the Left/Right arrow key or the knob to switch it.

Note:

- The low range provides better resolution and accuracy at low resistance settings.
- If the set resistance value is greater than the maximum value of the low range, you must select a high range.
- When the input voltage in CR mode is greater than 10 V, the low range cannot work normally.



CAUTION

Before switching the resistance range, please disable the channel input to avoid causing damage to the instrument or the DUT.

Set V_Limit

The upper limit of the voltage working in CR mode. The default unit for V_Limit is V, and it ranges from 0 V to 155 V.

- (1) In the main interface, press **V_Limit** to switch the parameter focus to "V_Limit".
- (2) Enter a value by using the numeric keys, arrow keys, or the knob. For setting methods, refer to the descriptions of the help information or refer to the descriptions in "**Parameter Setting Method**".

Set C_Limit

The upper limit of the current working in CR mode. The default unit for C_Limit is A, and it ranges from 0 A to 70 A.

- (1) In the main interface, press **C_Limit** to switch the parameter focus to "C_Limit".
- (2) Enter a value by using the numeric keys, arrow keys, or the knob. For setting methods, refer to the descriptions of the help information or refer to the descriptions in "**Parameter Setting Method**".

Set Von

When the input voltage is greater than the set starting voltage (Von), the load starts to sink the current. The default unit for Von is V, and it ranges from 0 V to 155 V. The default Von is 0 V. To enable or disable this function, refer to descriptions in "**Enable/Disable the Von Latch Function**".

- (1) In the main interface, press **Von** to switch the parameter focus to "Von".
- (2) Enter a value by using the numeric keys, arrow keys, or the knob. For setting methods, refer to the descriptions of the help information or refer to the descriptions in "**Parameter Setting Method**".

4. Turn on the channel input

Press **On/Off** to turn on the channel input. At this time, the actual input voltage, current, resistance, and power will be displayed in the main interface.

Note: Once the channel input is turned on, the load will not start to sink the current until the input voltage is greater than the starting voltage.



WARNING

To avoid electric shock, ensure that the DUT is connected to the input terminals of the load properly before you turn on the channel input.



CAUTION

When the fan stops working, the channel is disabled. Then, a message is displayed, "Fan stops running!"

5. View waveform display

Press the **waveform display key**  to enter the waveform display interface,

as shown in Figure 2-10. When you select "R" under "Data", you can view the resistance waveform. When changes occur to the input voltage, the current changes linearly to keep the resistance value unchanged. For detailed operations, refer to the descriptions in "**Waveform Display Function**" section. Press the **waveform display key**  again to exit the waveform display interface and return to the main interface of CR mode.

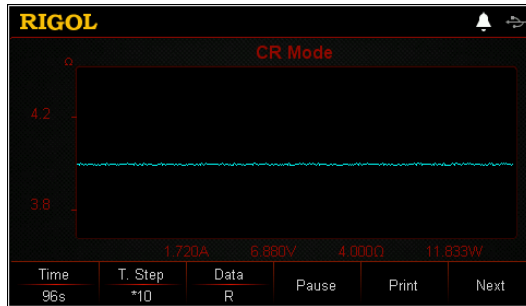

Figure 2-10 Waveform Display Interface of CR Mode

6. Exit CR mode

Press any key on the front panel of the load to exit CR mode.

Constant Power (CP) Mode

The load sinks a constant power in CP mode. The load current will change linearly proportional to the input voltage to keep sinking a constant power ($P = V \times I$), as shown in Figure 2-11.

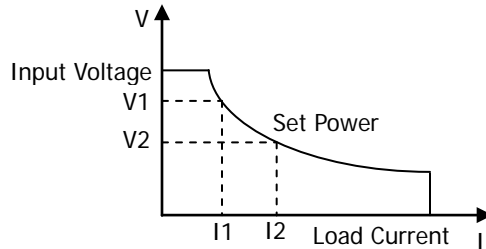

Figure 2-11 Constant Power (CP) Mode

Operation Procedures:

1. Power on the instrument

Press the **Power** key  on the front panel to power on the instrument.

2. Connect the DUT and the channel input terminals of the load

Connect the DUT and the channel input terminals on the front panel of the load as shown in Figure 2-2.



CAUTION

While making a connection, the positive polarity of the load should be connected to the (+) terminal of the channel output, and the negative polarity of the load to the (-) terminal of the channel output. A misconnection with the terminals may cause damage to the instrument or the DUT.

3. Set channel parameters

Press **CP** to enter the main interface of CP mode, as shown in Figure 2-12. At the top of the main interface, "CP" and "STATIC" are active. Of which, "STATIC" is highlighted.



Figure 2-12 Main Interface of CP Mode

In CP mode, you need to set the following parameters: Power, V_Limit, C_Limit.

Set Power

The constant power value in CP mode. The default unit for power is W.

- (1) In the main interface, press **Power** to switch the parameter focus to "Power".
- (2) Enter a value by using the numeric keys, arrow keys, or the knob. For the setting methods, refer to the descriptions of the built-in help information or refer to the descriptions in "**Parameter Setting Method**".

Set V_Limit

The upper limit of the voltage working in CP mode. The default unit for V_Limit is V, and it ranges from 0 V to 155 V.

- (1) In the main interface, press **V_Limit** to switch the parameter focus to "V_Limit".
- (2) Enter a value by using the numeric keys, arrow keys, or the knob. For the setting methods, refer to the descriptions of the built-in help information or refer to the descriptions in "**Parameter Setting Method**".

Set C_Limit

The upper limit of the current working in CP mode. The default unit for C_Limit is A, and it ranges from 0 A to 70 A.

- (1) In the main interface, press **C_Limit** to switch the parameter focus to "C_Limit".
- (2) Enter a value by using the numeric keys, arrow keys, or the knob. For the setting methods, refer to the descriptions of the built-in help information or refer to the descriptions in "**Parameter Setting Method**".

4. Turn on the channel input

Press **On/Off** to turn on the channel input. At this time, the actual input voltage, current, resistance, and power will be displayed in the main interface.



**WARNING**

To avoid electric shock, ensure that the DUT is connected to the input terminals of the load properly before you turn on the channel input.

**CAUTION**

When the fan stops working, the channel is disabled. Then, a message is displayed, "Fan stops running!"

5. View waveform display

Press the **waveform display key**  to enter the waveform display interface, as shown in Figure 2-13. When you select "P" under "Data", you can view the power waveform. When changes occur to the input voltage, the current changes linearly to keep the power value unchanged. For detailed operations, refer to the descriptions in "**Waveform Display Function**" section. Press the **waveform display key**  again to exit the waveform display interface and return to the main interface of CP mode.

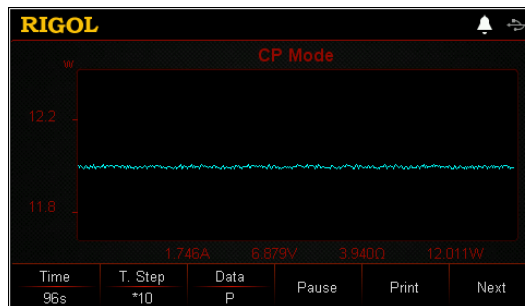

Figure 2-13 Waveform Display Interface of CP Mode

6. Exit CP mode

Press any key on the front panel of the load to exit CP mode.

Transient Test Function

Transient test function enables the load to periodically switch between two set levels (Level A and Level B). It can be used to test the transient characteristics of the DUT. Transient operation can only be used in CC mode and supports the following 3 operation modes:

- CC continuous mode (Con)
- CC pulsed mode (Pul)
- CC toggled mode (Tog)

Before performing the transient operation, first set parameters for the transient operation, such as Level A, Level B, frequency, duty, etc.

CC Continuous Mode (Con)

In continuous operation, when you enable the transient test, the load current will continuously switch over between Level A and Level B, as shown in Figure 2-14.

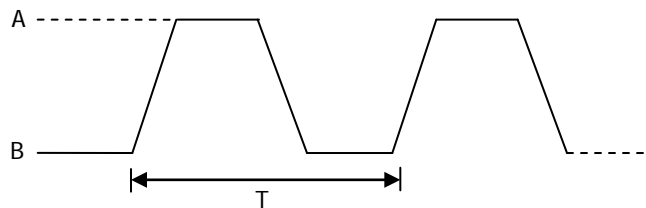

Figure 2-14 CC Continuous Mode (Con)

Operation Procedures:

1. Power on the instrument

Press the **Power** key  on the front panel to power on the instrument.

2. Connect the DUT and the channel input terminals of the load

Connect the DUT and the channel input terminals on the front panel of the load as shown in Figure 2-2.



CAUTION

While making a connection, the positive polarity of the load should be connected to the (+) terminal of the channel output, and the negative polarity of the load to the (-) terminal of the channel output. A misconnection with the terminals may cause damage to the instrument or the DUT.

3. Set channel parameters in the guide interface

Press **Con** to enter the Con guide interface, as shown in Figure 2-15. In the guide interface, you can configure parameters in the parameter configuration list and view the configuration diagram at the left of the configuration list in the real-time manner.

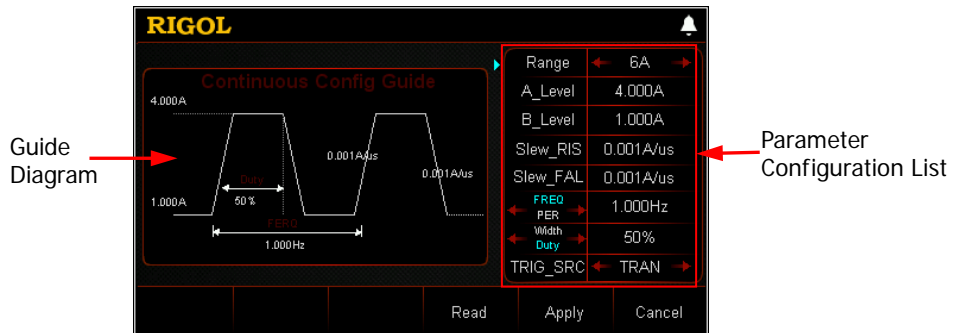

Figure 2-15 Guide Interface of Con Operation

The parameters for the continuous operation mode include range, Level A, Level B, rising slew rate, falling slew rate, frequency/period, width/duty, and trigger source.

Set Range

Working range for the current in Con mode. Two ranges are available.

DL3021/DL3021A: low range (0 to 4 A); high range (0 to 40 A)

DL3031/DL3031A: low range (0 to 6 A); high range (0 to 60 A)

- (1) In the guide interface, press the Up/Down arrow key to switch the parameter focus to "Range".
- (2) Use the Left/Right arrow key or the knob to switch the current working range.

Note:

- The low range provides better resolution and accuracy at low current settings.
- If the set current value is greater than the maximum value of the low range, you must select a high range.



CAUTION

Before switching the current range, please disable the channel input to avoid causing damage to the instrument or the DUT.

Set A_Level

The sink current toggles between a high value and a low value in Con mode.

A_Level indicates a high value. The default unit for A_Level is Ampere (A).

- (1) In the guide interface, press the Up/Down arrow key to switch the parameter focus to "A_Level".

- (2) Enter a value by using the numeric keys. For setting methods, refer to the descriptions in "**Parameter Setting Method**".

Note: The input value of A_Level should be within the set range.

Set B_Level

The sink current toggles between a high value and a low value in Con mode. B_Level indicates a low value. The default unit for B_Level is Ampere (A).

- (1) In the guide interface, press the Up/Down arrow key to switch the parameter focus to "B_Level".
- (2) Enter a value by using the numeric keys. For setting methods, refer to the descriptions in "**Parameter Setting Method**".

Note: The set A_Level and B_Level for a specified model should be within its specified high and low ranges for the model.

Set Slew_RIS

Sets the sink current slew rate for the positive transitions from Level B to Level A in Con mode. The default unit for the rising slew rate is A/ μ s.

- (1) In the guide interface, press the Up/Down arrow key to switch the parameter focus to "Slew_RIS".
- (2) Enter a value by using the numeric keys. For setting methods, refer to the descriptions in "**Parameter Setting Method**".

Set Slew_FAL

Sets the sink current slew rate for the negative transitions from Level A to Level B in Con mode. The default unit for the falling slew rate is A/ μ s.

- (1) In the guide interface, press the Up/Down arrow key to switch the parameter focus to "Slew_FAL".
- (2) Enter a value by using the numeric keys. For setting methods, refer to the descriptions in "**Parameter Setting Method**".

Set FREQ/PER

Period: The sum of time during which the sink current stays at Level A and Level B. The unit is s or ms.

Frequency: The reciprocal of period. The unit is Hz or kHz.

- (1) In the guide interface, press the Up/Down arrow key to switch the parameter focus to "FREQ/PER".
- (2) Enter a value by using the numeric keys. For setting methods, refer to the descriptions in "**Parameter Setting Method**".

Set Width/Duty

Width: The time during which the sink current stays at Level A when it switches to Level A in Con mode. Its unit is s or ms.

Duty: The ratio of duration of Level A to the period when the sink current switches to Level A in Con mode.

- (1) In the guide interface, press the Up/Down arrow key to switch the parameter focus to "Width/Duty". Then, press the Left/Right arrow key or the knob to select Width or Duty.
- (2) Enter a value by using the numeric keys. For setting methods, refer to the descriptions in "**Parameter Setting Method**".

Set TRIG_SRC

Three triggers are available in Con mode: BUS trigger, TRAN trigger, and DIGIO trigger.

- (1) In the guide interface, press the Up/Down arrow key to switch the parameter focus to "TRIG_SRC".
- (2) Press the Left/Right arrow key or rotate the knob to select the type of the trigger source.

4. Enter the main interface

In the guide interface, after you configure the parameters, press **Apply** to enter the main interface, as shown in Figure 2-16. At this time, the parameters are successfully configured. "CC" and "Continuous" are active at the top of the main interface. "Continuous" is highlighted. In the guide interface, if you give up configuring parameters, you can press **Cancel** to exit the guide interface and enter the main interface.

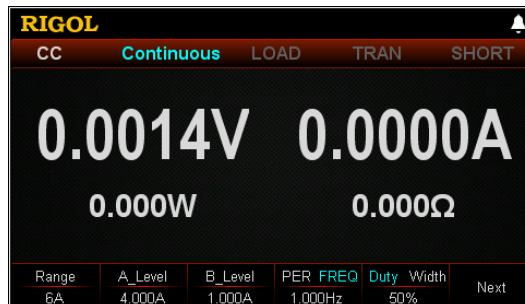

Figure 2-16 Main Interface of Con Operation

The menus of the main interface are displayed in three pages.

Menu items on Page 1: Range, A_Level, B_Level, PER/FREQ, Duty/Width, and Next.

Menu items on Page 2: Slew_RIS, Slew_FAL, TRIG_SRC, Guide, Next, and Back.

Menu items on Page 3: Read, Save, and Back.

To go to the next page, press **Next**; to exit the current page and go back to the previous page, press **Back**; to go back to the guide interface from the main interface, press **Guide**.

In the main interface, you can also set parameters based on your own needs.

The setting methods for the parameters are as follows:

Set Range

- (1) In the main interface, press **Range** to switch the parameter focus to "Range".
- (2) Press **Range** to switch the current working range. You can also use the Left/Right arrow key or the knob to switch it.

Set A_Level

- (1) In the main interface, press **A_Level** to switch the parameter focus to "A_Level".
- (2) Enter a value by using the numeric keys, arrow keys, or the knob. For setting methods, refer to the descriptions of the help information or refer to the descriptions in "**Parameter Setting Method**".

Set B_Level

- (1) In the main interface, press **B_Level** to switch the parameter focus to "B_Level".
- (2) Enter a value by using the numeric keys, arrow keys, or the knob. For setting methods, refer to the descriptions of the help information or refer to the descriptions in "**Parameter Setting Method**".

Set PER/FREQ

- (1) In the main interface, press **PER/FREQ** to switch the parameter focus to "PER/FREQ".
- (2) Press **PER/FREQ** to switch between Period and Frequency.
- (3) Enter a value by using the numeric keys, arrow keys, or the knob. For setting methods, refer to the descriptions of the help information or refer to the descriptions in "**Parameter Setting Method**".

Set Duty/Width

- (1) In the main interface, press **Duty/Width** to switch the parameter focus to "Duty/Width".
- (2) Press **Duty/Width** to switch between Duty and Width.
- (3) Enter a value by using the numeric keys, arrow keys, or the knob. For setting methods, refer to the descriptions of the help information or refer to the descriptions in "**Parameter Setting Method**".

Set Slew_RIS

- (1) In the main interface, press **Slew_RIS** to switch the parameter focus to "Slew_RIS".
- (2) Enter a value by using the numeric keys, arrow keys, or the knob. For setting methods, refer to the descriptions of the help information or refer to the descriptions in "**Parameter Setting Method**".

Set Slew_FAL

- (1) In the main interface, press **Slew_FAL** to switch the parameter focus to "Slew_FAL".

- (2) Enter a value by using the numeric keys, arrow keys, or the knob. For setting methods, refer to the descriptions of the help information or refer to the descriptions in "**Parameter Setting Method**".

Set TRIG_SRC

- (1) In the guide interface, press **TRIG_SRC** to switch the parameter focus to "TRIG_SRC".
- (2) Press **TRIG_SRC** to select the type of the trigger source. You can also use the Left/Right arrow key or the knob to select it.

Tip

In the guide interface, you can only use the numeric keys to input the value for the parameter; in the main interface, you can use the numeric keys, the arrow keys, or the knob to input the value for the parameter.

5. Enable trigger

After you enable the trigger, the actual input voltage, current, resistance, and power of the load will be displayed in the main interface.

Note: In Con mode, if the trigger is always enabled, the load will run based on the set parameters.

Tip

- You can enable the trigger first and then the load input is automatically turned on (The load sinks the current of Level B, and then the input will be updated according to the preset value). You can also press the **ON/OFF** key on the front panel first to turn on the input before you enable the trigger (The load sinks the current of Level B, and then waits trigger to occur. After the trigger is enabled, the input will be updated according to the preset value).
- After the trigger is enabled, the load current displayed in the main interface may stay at a constant value, because it is very fast for the current to transition from Level A to Level B. At this time, you can observe that the load current toggles between Level A and Level B in the dynamic waveform display interface.



WARNING



To avoid electric shock, ensure that the DUT is connected to the input terminals of the load properly before you enable the trigger.



CAUTION

When the fan stops working, the channel is disabled. Then, a message is displayed, "Fan stops running!"

6. View waveform display

After you enter the main interface, press the **waveform display key**  to enter the waveform display interface, as shown in Figure 2-17. By default, the waveform is displayed in Fast mode. You can observe that the load current toggles continuously between Level A and Level B. For detailed operations, refer to the descriptions in "**Waveform Display Function**" section. Press the **waveform display key**  again to exit the waveform display interface and return to the main interface of Con mode.

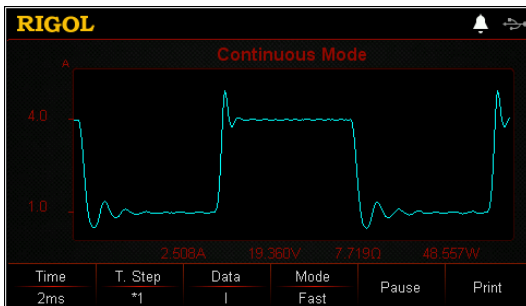

Figure 2-17 Waveform Display Interface of Con Mode

7. Save and read files

In the guide interface and main interface of Con mode, you can press **Save** to save the parameters for Con mode to the internal or external memory, and you can read and recall it if necessary by pressing **Read**.

(1) Save

After you complete the parameter setting, press **Save** to enter the storage and recall interface. The file is saved in ".CON" format. For detailed saving operation, refer to the descriptions in "**Save**".

(2) Read

Press **Read** to enter the storage and recall interface. Recall and read the files in ".CON" format or the ".RSF" files beginning with "CON_". For detailed reading operation, refer to descriptions in "Read". The files to be recalled and read are allowed to be edited.

How to press the **Store** key on the front to perform the saving and reading operation, refer to the descriptions in "**Store and Recall**".

8. Exit Con mode

Press any key on the front panel of the load to exit Con mode.

CC Pulsed Mode (Pul)

In the Pul mode, when you enable the transient test operation, the load current will switch from Level B to Level A once the load receives a trigger signal. After maintaining Level A for a specified pulse width, it will switch to Level B, as shown in Figure 2-18.

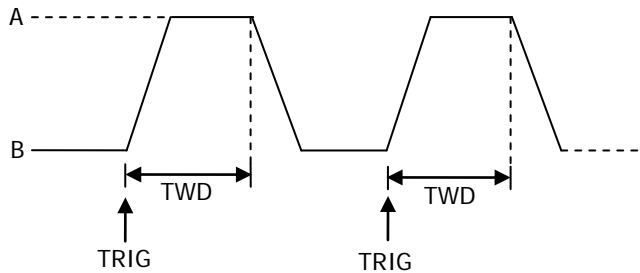



Figure 2-18 CC Pulsed Mode (Pul)

Operation Procedures:

1. Power on the instrument

Press the **Power** key  on the front panel to power on the instrument.

2. Connect the DUT and the channel input terminals of the load

Connect the DUT and the channel input terminals on the front panel of the load as shown in Figure 2-2.



CAUTION

While making a connection, the positive polarity of the load should be connected to the (+) terminal of the channel output, and the negative polarity of the load to the (-) terminal of the channel output. A misconnection with the terminals may cause damage to the instrument or the DUT.

3. Set channel parameters in the guide interface

Press **Pul** to enter the Pul guide interface, as shown in Figure 2-19. In the guide interface, you can configure parameters in the parameter configuration list and view the configuration diagram at the left of the configuration list in the real-time manner.

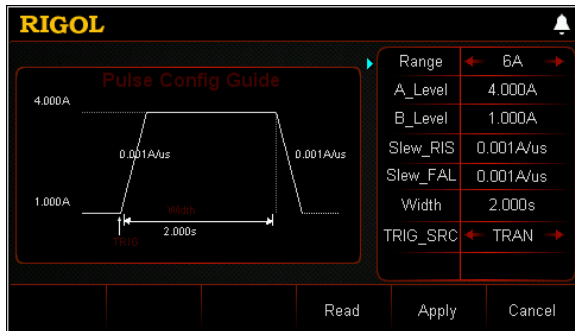

Figure 2-19 Guide Interface of Pul Operation

The parameters for the pulsed operation mode include range, Level A, Level B, rising slew rate, falling slew rate, width, and trigger source.

Set Range

The current working range in Pul mode. Two current ranges are available:
 DL3021/DL3021A: low range (0 to 4 A); high range (0 to 40 A)
 DL3031/DL3031A: low range (0 to 6 A); high range (0 to 60 A)

- (1) In the guide interface, press the Up/Down arrow key to switch the parameter focus to "Range".
- (2) Use the Left/Right arrow key or the knob to switch the current working range.

Note:

- The low range provides better resolution and accuracy at low current settings.
- If the set current value is greater than the maximum value of the low range, you must select a high range.



CAUTION

Before switching the current range, please disable the channel input to avoid causing damage to the instrument or the DUT.

Set A_Level

The sink current toggles between a high value and a low value in Pul mode. A_Level indicates a high value. The default unit for A_Level is Ampere (A).

- (1) In the guide interface, press the Up/Down arrow key to switch the parameter focus to "A_Level".
- (2) Enter a value by using the numeric keys. For the setting methods, refer to the descriptions in "**Parameter Setting Method**".

Note: The input value of A_Level should be within the set range.

Set B_Level

The sink current toggles between a high value and a low value in Pul mode. B_Level indicates a low value. The default unit for B_Level is Ampere (A).

- (1) In the guide interface, press the Up/Down arrow key to switch the parameter focus to "B_Level".
- (2) Enter a value by using the numeric keys. For the setting methods, refer to the descriptions in "**Parameter Setting Method**".

Note: The set A_Level and B_Level for a specified model should be within its specified high and low ranges for the model.

Set Slew_RIS

Sets the sink current slew rate for the positive transitions from Level B to Level A in Pul mode. The default unit for the rising slew rate is A/ μ s.

- (1) In the guide interface, press the Up/Down arrow key to switch the parameter focus to "Slew_RIS".
- (2) Enter a value by using the numeric keys. For the setting methods, refer to the descriptions in "**Parameter Setting Method**".

Set Slew_FAL

Sets the sink current slew rate for the negative transitions from Level A to Level B in Pul mode. The default unit for the falling slew rate is A/ μ s.

- (1) In the guide interface, press the Up/Down arrow key to switch the parameter focus to "Slew_FAL".
- (2) Enter a value by using the numeric keys. For the setting methods, refer to the descriptions in "**Parameter Setting Method**".

Set Width

The time during which the sink current stays at Level A when it switches to Level A in Pul mode. Its unit is s or ms.

- (1) In the guide interface, press the Up/Down arrow key to switch the parameter focus to "Width".
- (2) Enter a value by using the numeric keys. For the setting methods, refer to the descriptions of the built-in help information or refer to the descriptions in "**Parameter Setting Method**".

Set TRIG_SRC

Three triggers are available in Pul mode: BUS trigger, TRAN trigger, and DIGIO trigger.

- (1) In the guide interface, press the Up/Down arrow key to switch the parameter focus to "TRIG_SRC".
- (2) Press the Left/Right arrow key to select the type of the trigger source.

4. Enter the main interface

In the guide interface, after you configure the parameters, press **Apply** to enter the main interface, as shown in Figure 2-20. At this time, the parameters are

successfully configured. "CC" and "Pulse" are active at the top of the main interface. Of which, "Pulse" is highlighted. In the guide interface, if you give up configuring parameters, you can press **Cancel** to exit the guide interface and enter the main interface.

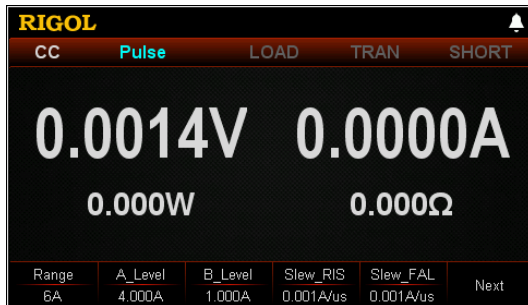

Figure 2-20 Main Interface of Pul Operation

The menus of the main interface are displayed in two pages.

Menu items on Page 1: Range, A_Level, B_Level, Slew_RIS, Slew_FAL, and Next.

Menu items on Page 2: Width, TRIG_SRC, Guide, Read, Save, and Back.

To go to the next page, press **Next**; to exit the current page and go back to the previous page, press **Back**; to go back to the guide interface from the main interface, press **Guide**.

In the main interface, you can also set parameters based on your own needs. The setting methods for the parameters are as follows:

Set Range

- (1) In the main interface, press **Range** to switch the parameter focus to "Range".
- (2) Press **Range** to switch the current working range. You can also use the Left/Right arrow key or the knob to switch it.

Set A_Level

- (1) In the main interface, press **A_Level** to switch the parameter focus to "A_Level".
- (2) Enter a value by using the numeric keys, arrow keys, or the knob. For the setting methods, refer to the descriptions of the built-in help information or refer to the descriptions in "**Parameter Setting Method**".

Set B_Level

- (1) In the main interface, press **B_Level** to switch the parameter focus to "B_Level".
- (2) Enter a value by using the numeric keys, arrow keys, or the knob. For setting methods, refer to the descriptions of the help information or refer to the descriptions in "**Parameter Setting Method**".

Set Slew_RIS

- (1) In the main interface, press **Slew_RIS** to switch the parameter focus to "Slew_RIS".
- (2) Enter a value by using the numeric keys, arrow keys, or the knob. For setting methods, refer to the descriptions of the help information or refer to the descriptions in "**Parameter Setting Method**".

Set Slew_FAL

- (1) In the main interface, press **Slew_FAL** to switch the parameter focus to "Slew_FAL".
- (2) Enter a value by using the numeric keys, arrow keys, or the knob. For setting methods, refer to the descriptions of the help information or refer to the descriptions in "**Parameter Setting Method**".

Set Width

- (1) In the main interface, press **Width** to switch the parameter focus to "Width".
- (2) Enter a value by using the numeric keys, arrow keys, or the knob. For setting methods, refer to the descriptions of the help information or refer to the descriptions in "**Parameter Setting Method**".

Set TRIG_SRC

- (1) In the main interface, press **TRIG_SRC** to switch the parameter focus to "TRIG_SRC".
- (2) Press **TRIG_SRC** to select the type of the trigger source. You can also use the Left/Right arrow key or the knob to select it.

Tip

In the guide interface, you can only use the numeric keys to input the value for the parameter; in the main interface, you can use the numeric keys, the arrow keys, or the knob to input the value for the parameter.

5. Enable trigger

After you enable the trigger, the actual input voltage, current, resistance, and power of the load will be displayed in the main interface.

Tip

You can enable the trigger first and then the load input is automatically turned on (The load sinks the current of Level B, and then the input will be updated according to the preset value). You can also press the **ON/OFF** key on the front panel first to turn on the input before you enable the trigger (The load sinks the current of Level B, and then waits trigger to occur. After the trigger is enabled, the input will be updated according to the preset value).



**WARNING**

To avoid electric shock, ensure that the DUT is connected to the input terminals of the load properly before you enable the trigger.

**CAUTION**

When the fan stops working, the channel is disabled. Then, a message is displayed, "Fan stops running!"

6. View waveform display

After you enter the main interface, press the **waveform display key**  to enter the waveform display interface, as shown in Figure 2-21. After the load current stays at Level A for a specified time (reach the set width), the trigger is disabled automatically. Then, the current automatically switches to Level B. For detailed operations, refer to the descriptions in "**Waveform Display Function**" section. Press the **waveform display key**  again to exit the waveform display interface and return to the main interface of Pul mode.

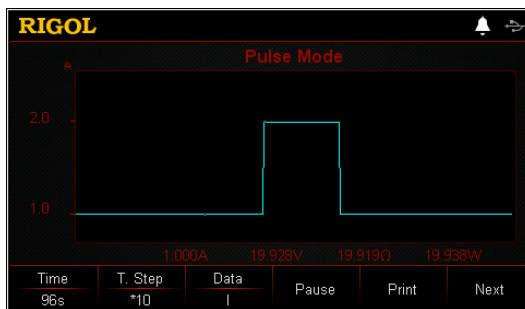

Figure 2-21 Waveform Display Interface of Pul Mode

7. Save and read files

In the guide interface and main interface of Pul mode, you can press **Save** to save the parameters for Pul mode to the internal or external memory, and you can read and recall it if necessary by pressing **Read**.

(1) Save

After you complete the parameter setting, press **Save** to enter the storage and recall interface. The file is saved in ".PUL" format. For detailed saving operation, refer to the descriptions in "**Save**".

(2) Read

Press **Read** to enter the storage and recall interface. Recall and read the files in ".PUL" format or the ".RSF" files beginning with "PUL_". For detailed reading operation, refer to descriptions in "**Read**". The files to be recalled and read are allowed to be edited.

How to press the **Store** key on the front to perform the saving and reading

operation, refer to the descriptions in "**Store and Recall**".

8. Exit Pul mode

Press any key on the front panel of the load to exit Pul mode.

CC Toggled Mode (Tog)

In Tog mode, when you enable the transient test, the load current will toggle for one time between Level A and Level B once the load receives a trigger signal, as shown in Figure 2-22.

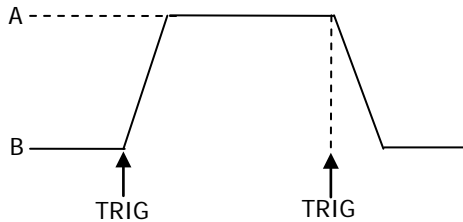

Figure 2-22 CC Toggled Mode (Tog)

Operation Procedures:

1. Power on the instrument

Press the **Power** key  on the front panel to power on the instrument.

2. Connect the DUT and the channel input terminals of the load

Connect the DUT and the channel input terminals on the front panel of the load as shown in Figure 2-2.



CAUTION

While making a connection, the positive polarity of the load should be connected to the (+) terminal of the channel output, and the negative polarity of the load to the (-) terminal of the channel output. A misconnection with the terminals may cause damage to the instrument or the DUT.

3. Set channel parameters in the guide interface

Press **Tog** to enter the Tog guide interface, as shown in Figure 2-23. In the guide interface, you can configure parameters in the parameter configuration list and view the configuration diagram at the left of the configuration list in the real-time manner.

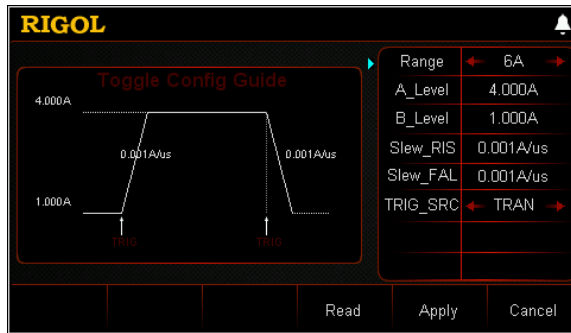

Figure 2-23 Guide Interface of Tog Operation

The parameters for the toggled operation mode include range, Level A, Level B, rising slew rate, falling slew rate, and trigger source.

Set Range

The current working range in Tog mode. Two current ranges are available:
 DL3021/DL3021A: low range (0 to 4 A); high range (0 to 40 A)
 DL3031/DL3031A: low range (0 to 6 A); high range (0 to 60 A)

- (1) In the guide interface, press the Up/Down arrow key to switch the parameter focus to "Range".
- (2) Use the Left/Right arrow key or the knob to switch the current working range.

Note:

- The low range provides better resolution and accuracy at low current settings.
- If the set current value is greater than the maximum value of the low range, you must select a high range.



CAUTION

Before switching the current range, please disable the channel input to avoid causing damage to the instrument or the DUT.

Set A_Level

The sink current toggles between a high value and a low value in Tog mode. A_Level indicates a high value. The default unit for A_Level is Ampere (A).

- (1) In the guide interface, press the Up/Down arrow key to switch the parameter focus to "A_Level".
- (2) Enter a value by using the numeric keys. For the setting methods, refer to the descriptions in "**Parameter Setting Method**".

Note: The input value of A_Level should be within the set range.

Set B_Level

The sink current toggles between a high value and a low value in Tog mode. B_Level indicates a low value. The default unit for B_Level is Ampere (A).

- (1) In the guide interface, press the Up/Down arrow key to switch the parameter focus to "B_Level".
- (2) Enter a value by using the numeric keys. For the setting methods, refer to the descriptions in "**Parameter Setting Method**".

Note: The set A_Level and B_Level for a specified model should be within its specified high and low ranges for the model.

Set Slew_RIS

Sets the sink current slew rate for the positive transitions from Level B to Level A in Tog mode. The default unit for the rising slew rate is A/ μ s.

- (1) In the guide interface, press the Up/Down arrow key to switch the parameter focus to "Slew_RIS".
- (2) Enter a value by using the numeric keys. For the setting methods, refer to the descriptions in "**Parameter Setting Method**".

Set Slew_FAL

Sets the sink current slew rate for the negative transitions from Level A to Level B in Tog mode. The default unit for the falling slew rate is A/ μ s.

- (1) In the guide interface, press the Up/Down arrow key to switch the parameter focus to "Slew_FAL".
- (2) Enter a value by using the numeric keys. For the setting methods, refer to the descriptions in "**Parameter Setting Method**".

Set TRIG_SRC

Three triggers are available in Pul mode: BUS trigger, TRAN trigger, and DIGIO trigger.

- (1) In the guide interface, press the Up/Down arrow key to switch the parameter focus to "TRIG_SRC".
- (2) Press the Left/Right arrow key to select the type of the trigger source.

4. Enter the main interface

In the guide interface, after you configure the parameters, press **Apply** to enter the main interface, as shown in Figure 2-24. At this time, the parameters are successfully configured. "CC" and "Toggle" are active at the top of the main interface. Of which, "Toggle" is highlighted. In the guide interface, if you give up configuring parameters, you can press **Cancel** to exit the guide interface and enter the main interface.

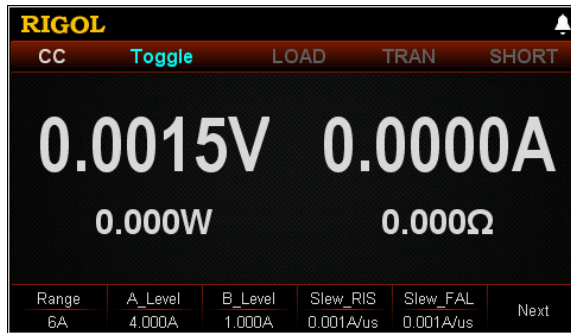

Figure 2-24 Main Interface of Tog Operation

The menus of the main interface are displayed in two pages.

Menu items on Page 1: Range, A_Level, B_Level, Slew_RIS, Slew_FAL, and Next.

Menu items on Page 2: TRIG_SRC, Guide, Read, Save, and Back.

To go to the next page, press **Next**; to exit the current page and go back to the previous page, press **Back**; to go back to the guide interface from the main interface, press **Guide**.

In the main interface, you can also set parameters based on your own needs. The setting methods for the parameters are as follows:

Set Range

- (1) In the main interface, press **Range** to switch the parameter focus to "Range".
- (2) Press **Range** to switch the current working range. You can also use the Left/Right arrow key or the knob to switch it.

Set A_Level

- (1) In the main interface, press **A_Level** to switch the parameter focus to "A_Level".
- (2) Enter a value by using the numeric keys, arrow keys, or the knob. For the setting methods, refer to the descriptions of the built-in help information or refer to the descriptions in "**Parameter Setting Method**".

Set B_Level

- (1) In the main interface, press **B_Level** to switch the parameter focus to "B_Level".
- (2) Enter a value by using the numeric keys, arrow keys, or the knob. For the setting methods, refer to the descriptions of the built-in help information or refer to the descriptions in "**Parameter Setting Method**".

Set Slew_RIS

- (1) In the main interface, press **Slew_RIS** to switch the parameter focus to "Slew_RIS".

- (2) Enter a value by using the numeric keys, arrow keys, or the knob. For setting methods, refer to the descriptions of the help information or refer to the descriptions in "**Parameter Setting Method**".

Set Slew_FAL

- (1) In the main interface, press **Slew_FAL** to switch the parameter focus to "Slew_FAL".
- (2) Enter a value by using the numeric keys, arrow keys, or the knob. For setting methods, refer to the descriptions of the help information or refer to the descriptions in "**Parameter Setting Method**".

Set TRIG_SRC

- (1) In the main interface, press **TRIG_SRC** to switch the parameter focus to "TRIG_SRC".
- (2) Press **TRIG_SRC** to select the type of the trigger source. You can also use the Left/Right arrow key or the knob to select it.

Tip

In the guide interface, you can only use the numeric keys to input the value for the parameter; in the main interface, you can use the numeric keys, the arrow keys, or the knob to input the value for the parameter.

5. Enable trigger

After you enable the trigger, the actual input voltage, current, resistance, and power of the load will be displayed in the main interface.

Tip

You can enable the trigger first and then the load input is automatically turned on (The load sinks the current of Level B, and then the input will be updated according to the preset value). You can also press the **ON/OFF** key on the front panel first to turn on the input before you enable the trigger (The load sinks the current of Level B, and then waits trigger to occur. After the trigger is enabled, the input will be updated according to the preset value).



WARNING



To avoid electric shock, ensure that the DUT is connected to the input terminals of the load properly before you enable the trigger.



CAUTION

When the fan stops working, the channel is disabled. Then, a message is displayed, "Fan stops running!"

6. View waveform display

After you enter the main interface, press the **waveform display key**  to enter the waveform display interface, as shown in Figure 2-25. The load current will always stay at Level A and it will not switch to Level B unless you disable the trigger manually. For detailed operations, refer to the descriptions in "**Waveform Display Function**". Press the **waveform display key**  again to exit the waveform display interface and return to the main interface of Tog mode.

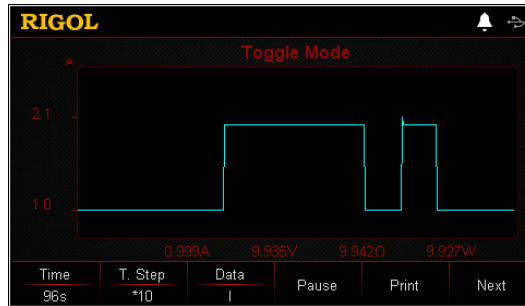

Figure 2-25 Waveform Display Interface of Tog Mode

7. Save and read files

In the guide interface and main interface of Tog mode, you can press **Save** to save the parameters for Tog mode to the internal or external memory, and you can read and recall it if necessary by pressing **Read**.

(1) Save

After you complete the parameter setting, press **Save** to enter the storage and recall interface. The file is saved in ".TOG" format. For detailed saving operation, refer to the descriptions in "**Save**".

(2) Read

Press **Read** to enter the storage and recall interface. Recall and read the files in ".TOG" format or the ".RSF" files beginning with "TOG_". For detailed reading operation, refer to descriptions in "**Read**". The files to be recalled and read are allowed to be edited.

How to press the **Store** key on the front to perform the saving and reading operation, refer to the descriptions in "**Store and Recall**".

8. Exit Tog mode

Press any key on the front panel of the load to exit Tog mode.

List Operation Function (List)

In list operation mode, you can perform the complex current/voltage/resistance/power modes accurately and rapidly, which may be synchronized with internal or external signals. In this way, you can complete the sophisticated test.

In this mode, when receiving a trigger signal, the load will operate according to the set execution mode and sequence. As shown in Figure 2-26, the load simulates the complex sequences of input changes based on the list parameters that you edit. The list function supports CC, CV, CR, and CP modes.

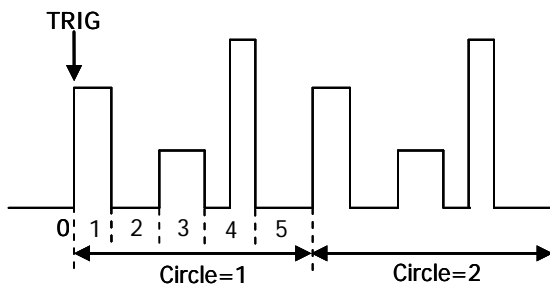

Figure 2-26 List Operation Function (List)

When selecting different trigger sources, you can generate complex sequences by editing the setting value for each step, the dwell time, and slew rate (the slew rate can only be edited in CC mode) to meet the complex test demands. All listed data is stored in a non-volatile memory. It means that the data will not be lost when the load is turned off.

Operation Procedures:

1. Power on the instrument

Press the **Power** key  on the front panel to power on the instrument.

2. Connect the DUT and the channel input terminals of the load

Connect the DUT and the channel input terminals on the front panel of the load as shown in Figure 2-2.



CAUTION

While making a connection, the positive polarity of the load should be connected to the (+) terminal of the channel output, and the negative polarity of the load to the (-) terminal of the channel output. A misconnection with the terminals may cause damage to the instrument and the devices connected to it.

3. Set channel parameters

Press **List** to enter the list function interface, as shown in Figure 2-27.



Figure 2-27 List Function Interface

The menus of the list function interface are displayed in two pages.

Menu items on Page 1: Mode, Range, Cycles, Steps, EndState, and Next.

Menu items on Page 2: TRIG_SRC, Save, Read, Record, and Back.

To go to the next page, press **Next**; to exit the current page and go back to the previous page, press **Back**.

The setting methods for the parameters are as follows:

Set Mode

Sets the working modes that the List function supports. The modes include CC, CV, CR, and CP.

- (1) In the List function interface, press **Mode** to switch the parameter focus to "Mode".
- (2) Press **Mode** to switch the working mode. You can also use the Left/Right arrow key or the knob to switch it.

Set Range

Selects a different range based on the current working mode of List. There is no range available in CP mode.

- If "CC" is selected to be the working mode, the range selection is as follows:
DL3021/DL3021A: low range (0 A to 4 A); high range (0 A to 40 A)
DL3031/DL3031A: low range (0 A to 6 A); high range (0 A to 60 A)
- If "CV" is selected to be the working mode, the range selection is as follows:
low range (0 V to 15 V); high range (0 V to 150 V)
- If "CR" is selected to be the working mode, the range selection is as follows:
low range (0.08 Ω to 15 Ω); high range (2 Ω to 15 kΩ)

- (1) In the List function interface, press **Range** to switch the parameter focus to "Range".

- (2) Press **Range** to switch the working range for different modes. You can also use the Left/Right arrow key or the knob to switch it.

Note:

- The low range provides better resolution and accuracy at low settings.
- If the set value is greater than the maximum value of the low range, you must select a high range.



CAUTION

Before switching the range, please disable the channel input to avoid causing damage to the instrument or the DUT.

Set Circle

Sets the number of times the list is cycled when timing input is completed based on the preset current/voltage/resistance/power. Its range is from 0 to 99999. When the value is 0, the value under "Circle" is displayed to be "Infinite", and then the load will be switched to infinite mode.

- (1) In the List function interface, press **Circle** to switch the parameter focus to "Circle".
- (2) Enter a value by using the numeric keys, arrow keys, or the knob. For setting methods, refer to the descriptions of the help information or refer to the descriptions in "**Parameter Setting Method**".

Set Steps

Sets the number of steps for the input preset current/voltage/resistance/power in each cycle. Its range is from 2 to 512.

- (1) In the List function interface, press **Steps** to switch the parameter focus to "Steps".
- (2) Enter a value by using the numeric keys, arrow keys, or the knob. For the setting methods, refer to the descriptions of the built-in help information or refer to the descriptions in "**Parameter Setting Method**".

Tip

- Total Steps = Steps x Circle
- You can edit up to 512 groups of data.

Set EndState

Last state: when the number of execution times (Circle) is a finite value, last state refers to the state the load stays after the load completes the total steps of current/voltage/resistance/power inputs.

Off: indicates that the input will be turned off automatically after the input is completed.

Last: keeps the input state of the last group after the input is completed.

- (1) In the List function interface, press **EndState** to switch the parameter focus to "EndState".

- (2) Press **EndState** to switch the last working state. You can also use the Left/Right arrow key or the knob to switch it.

Tip

When the number of execution times (Circle) is set to "Infinite", "EndState" is disabled and grayed out.

Set TRIG_SRC

Three triggers are available in List mode: BUS trigger, TRAN trigger, and DIGIO trigger.

- (1) In the main interface, press **TRIG_SRC** to switch the parameter focus to "TRIG_SRC".
- (2) Press **TRIG_SRC** to select the type of the trigger source. You can also use the Left/Right arrow key or the knob to select it.

Set Parameter List

The parameter list consists of the following parameters: Step, Value, Duration, Slew (only available in CC mode), V_Sampling (V)/C_Sampling (A). Step indicates the number of steps; Value indicates the value set for each step; Duration indicates the dwell time for each step; Slew indicates the slew rate for each step; V_Sampling (V) indicates the readback sampling voltage; and C_Sampling (A) indicates the readback sampling current. If the scrollbar is shown at the right side of the parameter list, it indicates that not all parameters are displayed in the current interface. At this time, press the Up/Down arrow key to go to the next page.

- (1) Select Step

The Step value in the parameter list is related to the setting of "Steps" in the menu. For example, press **Steps** to set it to 4, then the first 4 steps in the parameter list and the relevant parameters are highlighted.

If the number of steps that you set is a small value, you only need to use the Left/Right arrow key or the knob to directly select the desired number of steps.

If the number of steps that you set is a large value, you can input the desired steps by using the numeric keys first. After that, you will directly go to the column under the desired steps. For example, if you set Steps to 300, and you want to set the parameters for Step 250, then use the numeric keys to input 250 and you will go to Step 250 directly. At this time, you can set the relevant parameters.

If the parameter focus is currently not on the "Step" line, first press the Up/Down arrow key to switch the parameter focus to the "Step" line, and then select the desired steps.

(2) Enter Value

- In CC mode, the set value is for current, and its default unit is A.
 - In CV mode, the set value is for voltage, and its default unit is V.
 - In CR mode, the set value is for resistance, and its default unit is Ω .
 - In CP mode, the set value is for power, and its default unit is W.
- a) In the main interface, press the Up/Down arrow key to switch the parameter focus to the "Value" line.
 - b) Enter a value by using the numeric keys. For setting methods, refer to the descriptions in "**Parameter Setting Method**".

Note: If the parameter focus is on the "Value" line, press the Left/Right arrow key or rotate the knob to set the value for the adjacent step.

(3) Set Duration

The default unit for duration is s. Its range is 0.00005 s to 3600 s.

- Press the Up/Down arrow key to switch the parameter focus to the "Duration" line.
- Enter a value by using the numeric keys. For setting methods, refer to the descriptions in "**Parameter Setting Method**".

Note: When the current parameter focus is on the "Duration" line, press the Left/Right arrow key or rotate the knob to switch the parameter focus to the duration for the adjacent step.

(4) Set Slew (only available in CC mode)

The default unit for the slew rate is A/ μ s.

- In the main interface, press the Up/Down arrow key to switch the parameter focus to the "Slew" line.
- Enter a value by using the numeric keys. For setting methods, refer to the descriptions in "**Parameter Setting Method**".

Note: If the parameter focus is on the "Slew" line, press the Left/Right arrow key or rotate the knob to set the value for each step.

(5) Set V_Sampling (V)/C_Sampling (A)

After the list operation is finished, the readback value for each step in the last cycle (that is, the last sampling value stably displayed for each step in the last cycle) will be automatically displayed in the parameter list. In CC mode, readback voltage (V_Sampling (V)) is displayed; in CV mode, readback current (C_Sampling (A)) is displayed; and in CR and CP modes, both readback voltage (V_Sampling (V)) and readback current (C_Sampling (A)) are displayed.

4. Enable trigger

After you complete the parameter setting, turn on the trigger, and then the load

will input based on the current settings. If the trigger is turned off during the list operation, the next time you turn on the trigger, the load will continue inputting the last parameter where you stop the list operation.

- The actual input voltage, current, resistance, and power of the load will be displayed in the main interface in a real-time manner. In the parameter preview area, you can view the dynamic changes of the parameters in the parameter list.
- In the parameter list, the editing box is highlighted in green.
- If the number of execution times ("Cycles") is set to be a specified value, after completing the number of inputs (total steps), the load will terminate inputting. At this time, the end state of the load is determined by "EndState". When the number of execution times ("Cycles") is set to "Infinite", the load makes consecutive inputs based on the current parameter settings. At this time, the end state is invalid.

Tip

- After the trigger is enabled, the load input is automatically enabled (The load first inputs the data for the first step and then inputs according to the preset values). You can also press the **ON/OFF** key on the front panel first to turn on the input before you enable the trigger (The load first inputs the data for the first step and then wait for trigger to occur. After the trigger is enabled, the load inputs according to the preset values).
- Before enabling the trigger, ensure that the changes of the input will not affect the DUT.
- Please complete the parameter setting before enabling the trigger. During the list operation, you are not allowed to modify the parameters.

**WARNING**

To avoid electric shock, ensure that the DUT is connected to the input terminals of the load properly before you enable the trigger.

**CAUTION**

When the fan stops working, the channel is disabled. Then, a message is displayed, "Fan stops running!"

5. Save and read files

In the List function interface, you can press **Save** to save the parameters for List mode to the internal or external memory, and you can read and recall it if necessary by pressing **Read**.

(1) Save

After you complete the parameter setting, press **Save** to enter the storage

and recall interface. The file is saved in ".LST" format. For detailed saving operation, refer to the descriptions in "**Save**".

(2) Read

Press **Read** to enter the storage and recall interface. Recall and read the files in ".LST" format or the ".RSF" files beginning with "LST_". For detailed reading operation, refer to descriptions in "**Read**". The files to be recalled and read are allowed to be edited.

How to press the **Store** key on the front panel of the load to perform the saving and reading operation, refer to the descriptions in "**Store and Recall**".

6. Record data file

In the List function interface, you can press **Record** to record the data file and save it to the external memory in CSV format. During recording, "Record" is displayed at the top of the interface. Press **Record** again to stop recording, and then "Record" is not displayed at the top of the interface.

Tip

Connect the external memory U Disk to the PC, and read the data files in CSV format from the U Disk.

7. Exit List mode

Press any key on the front panel of the load to exit List mode.

Application Function

The load supports the following three application functions. Press **APP** to switch among the three functions.

- OCP test function
- OPP test function
- Battery test function

OCP Test Function

OCP test principle (as shown in Figure 2-28)

When the OCP test starts, after the input voltage reaches V_{on} , the load will delay for a period, then starts to sink the current, increasing with incrementing steps at a certain interval. Meanwhile, the load will compare the detected voltage value with the OCP protection voltage value. If higher than the protection voltage value, the load proceeds to run and increases with incrementing steps until reaching the protection voltage.

If OCP occurs to the DUT, judge whether the current under test is within the maximum and minimum current range. If yes, the load passes the OCP test. Digital output of I/O interface on the rear panel is 0. If no, the load fails the test. Digital output of I/O interface on the rear panel is 1.

If no OCP occurs to the DUT and the set protection time times out, the load automatically stops sinking. The OCP test fails, and the test ends.

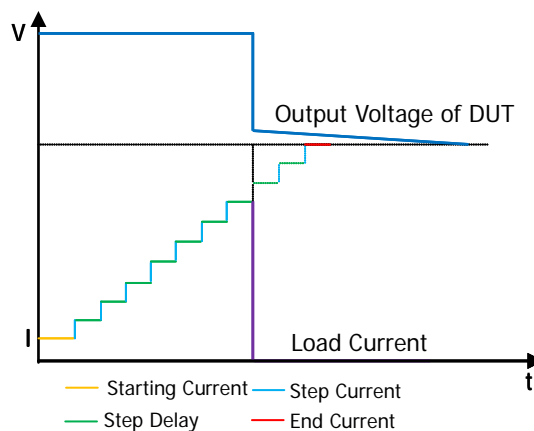

Figure 2-28 OCP Test Function

Tip

In the system setting menu, set the digital output to be "Disable", then the OCP test status is associated with the digital output of I/O interface on the rear panel.

Operation Procedures:

1. Power on the instrument

Press the **Power** key  on the front panel to power on the instrument.

2. Connect the DUT and the channel input terminals of the load

Connect the DUT and the channel input terminals on the front panel of the load as shown in Figure 2-2.



CAUTION

While making a connection, the positive polarity of the load should be connected to the (+) terminal of the channel output, and the negative polarity of the load to the (-) terminal of the channel output. A misconnection with the terminals may cause damage to the instrument or the DUT.

3. Set channel parameters in the guide interface

Press **APP** to switch to the guide interface of the OCP test function, as shown in Figure 2-29. In the guide interface, you can configure parameters in the parameter configuration list and view the configuration diagram at the left of the configuration list in the real-time manner. If the scrollbar appears at the right side of the parameter list, it indicates that not all parameters are displayed in the current interface. At this time, press the Up/Down arrow key to go to the next page.

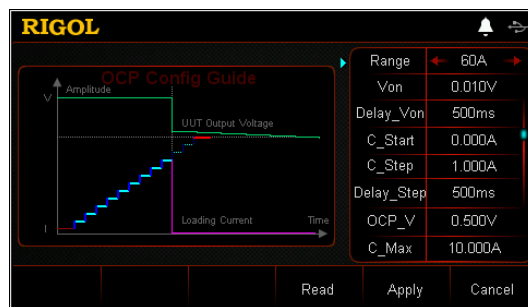

Figure 2-29 Guide Interface of OCP Test Function

The parameters for the OCP test function include range, starting voltage, delay time, starting current, step current, step delay, protection voltage, maximum current, minimum current, and protection time.

Set Range

The current working range for the OCP test function. Two current ranges are available:

DL3021/DL3021A: low range (0 to 4 A); high range (0 to 40 A)

DL3031/DL3031A: low range (0 to 6 A); high range (0 to 60 A)

(1) In the guide interface, press the Up/Down arrow key to switch the

- parameter focus to **"Range"**.
- (2) Use the Left/Right arrow key or the knob to switch the current working range.

Note:

- The low range provides better resolution and accuracy at low current settings.
- If the set current value is greater than the maximum value of the low range, you must select a high range.

Set Von

When the input voltage is greater than the set starting voltage (Von), the load starts to sink the current. The default unit for Von is V, and it ranges from 0 V to 150 V. The default Von is 0.01 V.

- (1) In the guide interface, press the Up/Down arrow key to switch the parameter focus to "Von".
- (2) Enter a value by using the numeric keys. For setting methods, refer to the descriptions in **"Parameter Setting Method"**.

Set Delay_Von

Sets the time period for how long the load starts to sink the current after the input voltage reaches Von. The default unit for the delay time is ms.

- (1) In the guide interface, press the Up/Down arrow key to switch the parameter focus to **"Delay_Von"**.
- (2) Enter a value by using the numeric keys. For setting methods, refer to the descriptions in **"Parameter Setting Method"**.

Set C_Start

The current value when the load starts in OCP test mode. The default unit for the value is A.

- (1) In the guide interface, press the Up/Down arrow key to switch the parameter focus to "C_Start".
- (2) Enter a value by using the numeric keys. For setting methods, refer to the descriptions in **"Parameter Setting Method"**.

Set C_Step

The step current in OCP test mode. The default unit for the value is A.

- (1) In the guide interface, press the Up/Down arrow key to switch the parameter focus to "C_Step".
- (2) Enter a value by using the numeric keys. For setting methods, refer to the descriptions in **"Parameter Setting Method"**.

Set Delay_Step

The time interval during which the current moves from step to step in OCP test mode. The default unit for the value is ms.

- (1) In the guide interface, press the Up/Down arrow key to switch the parameter focus to "Delay_Step".
- (2) Enter a value by using the numeric keys. For setting methods, refer to the descriptions in "**Parameter Setting Method**".

Set OCP_V

The protection voltage in the OCP test mode. The default unit for the value is V.

- (1) In the guide interface, press the Up/Down arrow key to switch the parameter focus to "OCP_V".
- (2) Enter a value by using the numeric keys. For setting methods, refer to the descriptions in "**Parameter Setting Method**".

Set C_Max

The maximum value of the protection current in the OCP test mode. The default unit for the value is A.

- (1) In the guide interface, press the Up/Down arrow key to switch the parameter focus to "C_Max".
- (2) Enter a value by using the numeric keys. For setting methods, refer to the descriptions in "**Parameter Setting Method**".

Set C_Min

The minimum value of the protection current in the OCP test mode. The default unit for the value is A.

- (1) In the guide interface, press the Up/Down arrow key to switch the parameter focus to "C_Min".
- (2) Enter a value by using the numeric keys. For setting methods, refer to the descriptions in "**Parameter Setting Method**".

Set T_Limit

The maximum overcurrent protection time in OCP mode. If no action is performed during the protection time, the load will automatically stop sinking the current. The default unit for the value is μs .

- (1) In the guide interface, press the Up/Down arrow key to switch the parameter focus to "T_Limit".
- (2) Enter a value by using the numeric keys. For setting methods, refer to the descriptions in "**Parameter Setting Method**".

4. Enter the main interface

In the guide interface, after you configure the parameters, press **Apply** to enter the main interface, as shown in Figure 2-30. At this time, "OCP" is active at the top of the main interface, which indicates that the parameters have been successfully configured. In the guide interface, if you give up configuring parameters, you can press **Cancel** to exit the guide interface and enter the main interface.



Figure 2-30 Main Interface of OCP Test Function

The menus of the main interface are displayed in three pages.

Menu items on Page 1: Range, Von, Delay_Von, C_Start, C_Step, and Next.

Menu items on Page 2: Delay_Step, OCP_V, C_Max, C_Min, Back, and Next.

Menu items on Page 3: T_Limit, Guide, Read, Save, and Back.

To go to the next page, press **Next**; to exit the current page and go back to the previous page, press **Back**; to go back to the guide interface from the main interface, press **Guide**.

In the main interface, you can also set parameters based on your own needs. The setting methods for the parameters are as follows:

Set Range

- (1) In the main interface, press **Range** to switch the parameter focus to "Range".
- (2) Press **Range** to switch the current working range. You can also use the Left/Right arrow key or the knob to switch it.

Set Von

- (1) In the main interface, press **Von** to switch the parameter focus to "Von".
- (2) Enter a value by using the numeric keys, arrow keys, or the knob. For the setting methods, refer to the descriptions of the built-in help information or refer to the descriptions in "**Parameter Setting Method**".

Set Delay_Von

- (1) In the main interface, press **Delay_Von** to switch the parameter focus to "Delay_Von".
- (2) Enter a value by using the numeric keys, arrow keys, or the knob. For setting methods, refer to the descriptions of the help information or refer to the descriptions in "**Parameter Setting Method**".

Set C_Start

- (1) In the main interface, press **C_Start** to switch the parameter focus to "C_Start".
- (2) Enter a value by using the numeric keys, arrow keys, or the knob. For setting methods, refer to the descriptions of the help information or refer to

the descriptions in "**Parameter Setting Method**".

Set C_Step

- (1) In the main interface, press **C_Step** to switch the parameter focus to "C_Step".
- (2) Enter a value by using the numeric keys, arrow keys, or the knob. For the setting methods, refer to the descriptions of the built-in help information or refer to the descriptions in "**Parameter Setting Method**".

Set Delay_Step

- (1) In the main interface, press **Delay_Step** to switch the parameter focus to "Delay_Step".
- (2) Enter a value by using the numeric keys, arrow keys, or the knob. For the setting methods, refer to the descriptions of the built-in help information or refer to the descriptions in "**Parameter Setting Method**".

Set OCP_V

- (1) In the main interface, press **OCP_V** to switch the parameter focus to "OCP_V".
- (2) Enter a value by using the numeric keys, arrow keys, or the knob. For the setting methods, refer to the descriptions of the built-in help information or refer to the descriptions in "**Parameter Setting Method**".

Set C_Max

- (1) In the main interface, press **C_Max** to switch the parameter focus to "C_Max".
- (2) Enter a value by using the numeric keys, arrow keys, or the knob. For the setting methods, refer to the descriptions of the built-in help information or refer to the descriptions in "**Parameter Setting Method**".

Set C_Min

- (1) In the main interface, press **C_Min** to switch the parameter focus to "C_Min".
- (2) Enter a value by using the numeric keys, arrow keys, or the knob. For setting methods, refer to the descriptions of the help information or refer to the descriptions in "**Parameter Setting Method**".

Set T_Limit

- (1) In the main interface, press **T_Limit** to switch the parameter focus to "T_Limit".
- (2) Enter a value by using the numeric keys, arrow keys, or the knob. For setting methods, refer to the descriptions of the help information or refer to the descriptions in "**Parameter Setting Method**".

Tip

In the guide interface, you can only use the numeric keys to input the value for the parameter; in the main interface, you can use the numeric keys, the arrow keys, or the knob to input the value for the parameter.

5. Turn on the channel input

Press **On/Off** to turn on the channel input. At this time, the actual input voltage, current, resistance, and power will be displayed in the main interface. If the load passes the test, a prompt message is displayed, "OCP test passed!" The DUT will automatically turn off output. If the load fails the test, one of the following prompt messages is displayed: "Upper limit exceeded. OCP test failed!" "Lower limit exceeded. OCP test failed!" Or "Timeout! OCP test failed!" Then, the channel input of the load will be automatically turned off.



**WARNING**

To avoid electric shock, ensure that the DUT is connected to the input terminals of the load properly before you turn on the channel input.

**CAUTION**

When the fan stops working, the channel is disabled. Then, a message is displayed, "Fan stops running!"

6. View waveform display

After you enter the main interface, press the **waveform display key**  to enter the waveform display interface, as shown in Figure 2-31. The current will have a stepped increase. If the OCP test is successful, the current will increase until it reaches the protection current of the DUT; if the OCP test fails, the current will increase until it reaches the set maximum current. For detailed operations, refer to the descriptions in "**Waveform Display Function**" section. Press the **waveform display key**  again to exit the waveform display interface and return to the main interface of OCP test function.

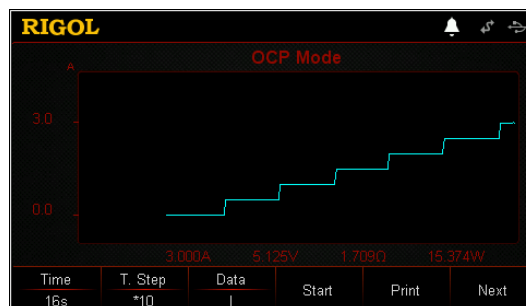

Figure 2-31 OCP Waveform Display Interface

7. Save and read files

In the guide interface and main interface of OCP test mode, you can press **Save** to save the parameters for the OCP test mode to the internal or external memory, and you can read and recall it if necessary by pressing **Read**.

(1) Save

After you complete the parameter setting, press **Save** to enter the storage and recall interface. The file is saved in ".OCP" format. For detailed saving operation, refer to the descriptions in "**Save**".

(2) Read

Press **Read** to enter the storage and recall interface. Select the files that are in ".OCP" format or the ".RSF" files beginning with "OCP_" to read and recall. For detailed reading operation, refer to descriptions in "**Read**". The files to be recalled and read are allowed to be edited.

How to press the **Store** key on the front panel of the load to perform the saving and reading operation, refer to the descriptions in "**Store and Recall**".

8. Exit the OCP test function

Press any key on the front panel of the load to exit the OCP test mode.

OPP Test Function

OPP test principle (as shown in Figure 2-32):

When the OPP test starts, after the input voltage reaches V_{on} , the load will delay for a period, then the DUT starts to work according to the starting power. The power increases with increasing with incrementing steps at a certain interval. Meanwhile, the load will compare the detected voltage value with the protection voltage value of the OPP test. If higher than the protection voltage value, the load proceeds to run and increases with incrementing steps until reaching the protection voltage.

If OPP occurs to the DUT, judge whether the power under test is within the set maximum and minimum power range. If yes, the load passes the OPP test. Digital output of I/O interface on the rear panel is 0. If no, the load fails the test. Digital output of I/O interface on the rear panel is 1.

If no OPP occurs to the DUT and the set protection time times out, the load automatically stops sinking. The OPP test fails, and the test ends.

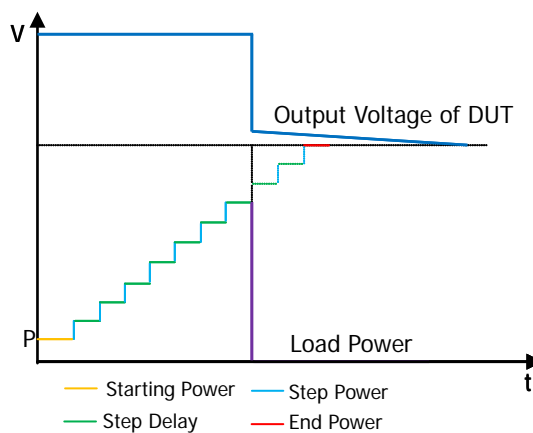

Figure 2-32 OPP Test Function

Tip

In the system setting menu, set the digital output to be "Disable", then the OPP test status is associated with the digital output of I/O interface on the rear panel.

Operation Procedures:

1. Power on the instrument

Press the **Power** key  on the front panel to power on the instrument.

2. Connect the DUT and the channel input terminals of the load

Connect the DUT and the channel input terminals on the front panel of the load

as shown in Figure 2-2.



CAUTION

While making a connection, the positive polarity of the load should be connected to the (+) terminal of the channel output, and the negative polarity of the load to the (-) terminal of the channel output. A misconnection with the terminals may cause damage to the instrument or the DUT.

3. Set channel parameters in the guide interface

Press **APP** to switch to the guide interface of the OPP test function, as shown in Figure 2-33. In the guide interface, you can configure parameters in the parameter configuration list and view the configuration diagram at the left of the configuration list in the real-time manner. If the scrollbar appears at the right side of the parameter list, it indicates that not all parameters are displayed in the current interface. At this time, press the Up/Down arrow key to go to the next page.

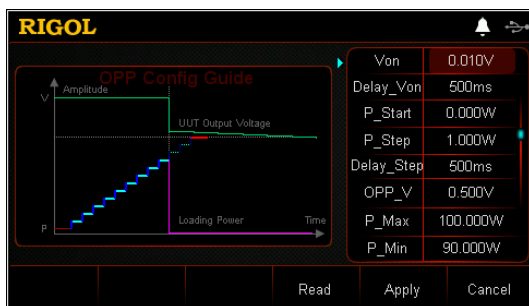

Figure 2-33 Guide Interface of OPP Test Function

The parameters for the OPP test function include starting voltage, delay time, starting power, step power, step delay, protection voltage, maximum power, minimum power, and protection time.

Set Von

When the input voltage is greater than the set starting voltage (Von), the load starts to sink the current. The default unit for Von is V, and it ranges from 0 V to 150 V. The default Von is 0.01 V.

- (1) In the guide interface, press the Up/Down arrow key to switch the parameter focus to "Von".
- (2) Enter a value by using the numeric keys. For setting methods, refer to the descriptions in "**Parameter Setting Method**".

Set Delay_Von

Sets the time period for how long the load starts to sink the current after the input voltage reaches Von. The default unit for the delay time is ms.

- (1) In the guide interface, press the Up/Down arrow key to switch the

parameter focus to "**Delay_Von**".

- (2) Enter a value by using the numeric keys. For setting methods, refer to the descriptions in "**Parameter Setting Method**".

Set P_Start

The power value when the load starts in OPP test mode. The default unit for the value is W.

- (1) In the guide interface, press the Up/Down arrow key to switch the parameter focus to "P_Start".
- (2) Enter a value by using the numeric keys. For setting methods, refer to the descriptions in "**Parameter Setting Method**".

Set P_Step

The step power in OPP test mode. The default unit for the value is W.

- (1) In the guide interface, press the Up/Down arrow key to switch the parameter focus to "P_Step".
- (2) Enter a value by using the numeric keys. For setting methods, refer to the descriptions in "**Parameter Setting Method**".

Set Delay_Step

The time interval during which the power moves from step to step in OPP test mode. The default unit for the value is ms.

- (1) In the guide interface, press the Up/Down arrow key to switch the parameter focus to "Delay_Step".
- (2) Enter a value by using the numeric keys. For setting methods, refer to the descriptions in "**Parameter Setting Method**".

Set OPP_V

The protection voltage in the OPP test mode. The default unit for the value is V.

- (1) In the guide interface, press the Up/Down arrow key to switch the parameter focus to "OPP_V".
- (2) Enter a value by using the numeric keys. For setting methods, refer to the descriptions in "**Parameter Setting Method**".

Set P_Max

The maximum value of the protection power in the OPP test mode. The default unit for the value is W.

- (1) In the guide interface, press the Up/Down arrow key to switch the parameter focus to "P_Max".
- (2) Enter a value by using the numeric keys. For setting methods, refer to the descriptions in "**Parameter Setting Method**".

Set P_Min

The minimum value of the protection power in the OPP test mode. The default unit for the value is W.

- (1) In the guide interface, press the Up/Down arrow key to switch the

parameter focus to "P_Min".

- (2) Enter a value by using the numeric keys. For setting methods, refer to the descriptions in "**Parameter Setting Method**".

Set T_Limit

The maximum overpower protection time in OPP mode. If no action is performed during the protection time, the load will automatically stop sinking the current. The default unit for the value is μs .

- (1) In the guide interface, press the Up/Down arrow key to switch the parameter focus to "T_Limit".
- (2) Enter a value by using the numeric keys. For setting methods, refer to the descriptions in "**Parameter Setting Method**".

4. Enter the main interface

In the guide interface, after you configure the parameters, press **Apply** to enter the main interface, as shown in Figure 2-34. At this time, "OPP" is active at the top of the main interface, which indicates that the parameters have been successfully configured. In the guide interface, if you give up configuring parameters, you can press **Cancel** to exit the guide interface and enter the main interface.



Figure 2-34 Main Interface of OPP Test Function

The menus of the main interface are displayed in three pages.

Menu items on Page 1: Von, Delay_Von, P_Start, P_Step, Delay_Step, and Next.

Menu items on Page 2: OPP_V, P_Max, P_Min, T_Limit, Back, and Next.

Menu items on Page 3: Guide, Read, Save, and Back.

To go to the next page, press **Next**; to exit the current page and go back to the previous page, press **Back**; to go back to the guide interface from the main interface, press **Guide**.

In the main interface, you can also set parameters based on your own needs. The setting methods for the parameters are as follows:

Set Von

- (1) In the main interface, press **Von** to switch the parameter focus to "Von".
- (2) Enter a value by using the numeric keys, arrow keys, or the knob. For

setting methods, refer to the descriptions of the help information or refer to the descriptions in "**Parameter Setting Method**".

Set Delay_Von

- (1) In the main interface, press **Delay_Von** to switch the parameter focus to "Delay_Von".
- (2) Enter a value by using the numeric keys, arrow keys, or the knob. For setting methods, refer to the descriptions of the help information or refer to the descriptions in "**Parameter Setting Method**".

Set P_Start

- (1) In the main interface, press **P_Start** to switch the parameter focus to "P_Start".
- (2) Enter a value by using the numeric keys, arrow keys, or the knob. For setting methods, refer to the descriptions of the help information or refer to the descriptions in "**Parameter Setting Method**".

Set P_Step

- (1) In the main interface, press **P_Step** to switch the parameter focus to "P_Step".
- (2) Enter a value by using the numeric keys, arrow keys, or the knob. For setting methods, refer to the descriptions of the help information or refer to the descriptions in "**Parameter Setting Method**".

Set Delay_Step

- (1) In the main interface, press **Delay_Step** to switch the parameter focus to "Delay_Step".
- (2) Enter a value by using the numeric keys, arrow keys, or the knob. For setting methods, refer to the descriptions of the help information or refer to the descriptions in "**Parameter Setting Method**".

Set OPP_V

- (1) In the main interface, press **OPP_V** to switch the parameter focus to "OPP_V".
- (2) Enter a value by using the numeric keys, arrow keys, or the knob. For setting methods, refer to the descriptions of the help information or refer to the descriptions in "**Parameter Setting Method**".

Set P_Max

- (1) In the main interface, press **P_Max** to switch the parameter focus to "P_Max".
- (2) Enter a value by using the numeric keys, arrow keys, or the knob. For setting methods, refer to the descriptions of the help information or refer to the descriptions in "**Parameter Setting Method**".

Set P_Min

- (1) In the main interface, press **P_Min** to switch the parameter focus to "P_Min".
- (2) Enter a value by using the numeric keys, arrow keys, or the knob. For setting methods, refer to the descriptions of the help information or refer to the descriptions in "**Parameter Setting Method**".

Set T_Limit

- (1) In the main interface, press **T_Limit** to switch the parameter focus to "T_Limit".
- (2) Enter a value by using the numeric keys, arrow keys, or the knob. For setting methods, refer to the descriptions of the help information or refer to the descriptions in "**Parameter Setting Method**".

Tip

In the guide interface, you can only use the numeric keys to input the value for the parameter; in the main interface, you can use the numeric keys, the arrow keys, or the knob to input the value for the parameter.

5. Turn on the channel input

Press **On/Off** to turn on the channel input. At this time, the actual input voltage, current, resistance, and power will be displayed in the main interface. If the load passes the test, a prompt message is displayed, "OPP test passed!" The DUT will automatically turn off output.

If the load fails the test, one of the following prompt messages is displayed: "Upper limit exceeded. OPP test failed!" "Lower limit exceeded. OPP test failed!" Or "Timeout! OPP test failed!"



WARNING



To avoid electric shock, ensure that the DUT is connected to the input terminals of the load properly before you turn on the channel input.



CAUTION

When the fan stops working, the channel is disabled. Then, a message is displayed, "Fan stops running!"

6. View waveform display

After you enter the main interface, press the **waveform display key**  to enter the waveform display interface, as shown in Figure 2-35. The power will have a stepped increase. If the OPP test is successful, the power will increase until it reaches the protection power of the DUT; if the OPP test fails, the power will increase until it reaches the set maximum power. For detailed operations, refer to the descriptions in "**Waveform Display Function**" section. Press the **waveform display key**  again to exit the waveform display interface and

return to the main interface of OPP test function.

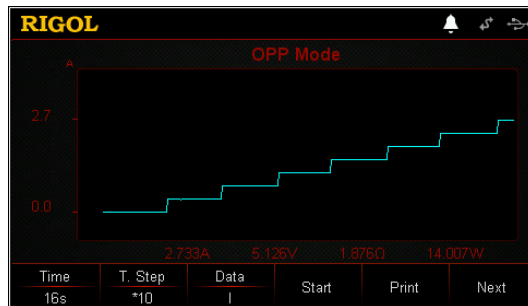

Figure 2-35 OPP Waveform Display Interface

7. Save and read files

In the guide interface and main interface of OPP test mode, you can press **Save** to save the parameters for the OPP test mode to the internal or external memory, and you can read and recall it if necessary by pressing **Read**.

(1) Save

After you complete the parameter setting, press **Save** to enter the storage and recall interface. The file is saved in ".OPP" format. For detailed saving operation, refer to the descriptions in "**Save**".

(2) Read

Press **Read** to enter the storage and recall interface. Select the files that are in ".OPP" format or the ".RSF" files beginning with "OPP_" to read and recall. For detailed reading operation, refer to descriptions in "**Read**". The files to be recalled and read are allowed to be edited.

How to press the **Store** key on the front panel of the load to perform the saving and reading operation, refer to the descriptions in "**Store and Recall**".

8. Exit the OPP test function

Press any key on the front panel of the load to exit the OPP test function.

Battery Test Function

Battery test principle (as shown in Figure 2-36):

A test for discharging the battery in CC mode. You can set the termination conditions: cut-off voltage value, battery capacity value, and discharge time. When any one of the three conditions is met, the discharge stops. Then the load automatically stops sinking. When only one or two condition(s) is/are selected as the termination condition(s) for the battery test, set the rest termination conditions not in use to be "OFF".

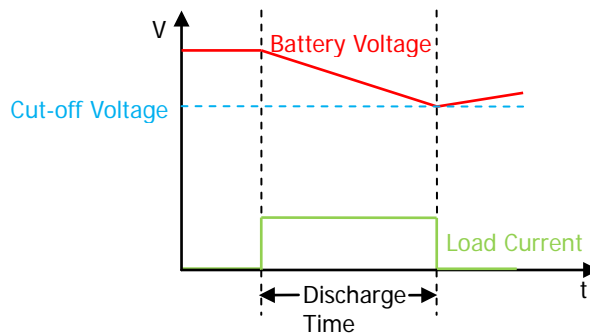

Figure 2-36 Battery Test Function

The battery test can reflect the reliability of the battery and the remaining battery life. Therefore, before replacing the battery, do the battery test first.

Operation Procedures:

1. Power on the instrument

Press the **Power** key  on the front panel to power on the instrument.

2. Connect the battery to the channel input terminals of the load

Connect the battery to the channel input terminals on the front panel of the load as shown in Figure 2-2.



CAUTION

While making a connection, the positive polarity of the load should be connected to the (+) terminal of the channel output, and the negative polarity of the load to the (-) terminal of the channel output. A misconnection with the terminals may cause damage to the instrument or the DUT.

3. Set channel parameters

Press  to switch to the main interface of Battery test function, as shown in Figure 2-37. "Battery" is active at the top of the main interface.

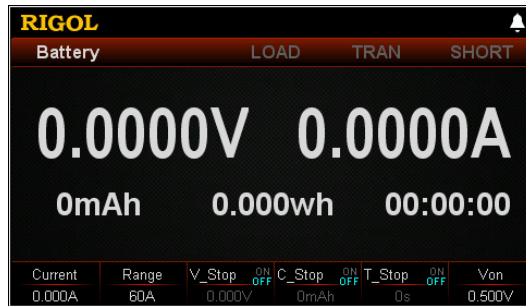

Figure 2-37 Main Interface of Battery Test Function

The parameters for the battery test function include current, range, cut-off voltage, battery capacity, discharge time, and starting voltage.

Set Current

The discharge current. Its default unit is A.

- (1) In the main interface, press **Current** to switch the parameter focus to "Current".
- (2) Enter a value by using the numeric keys, arrow keys, or the knob. For setting methods, refer to the descriptions of the help information or refer to the descriptions in "**Parameter Setting Method**".

Set Range

Working range for the current in battery test mode. Two ranges are available.

DL3021/DL3021A: low range (0 to 4 A); high range (0 to 40 A)

DL3031/DL3031A: low range (0 to 6 A); high range (0 to 60 A)

- (1) In the main interface, press **Range** to switch the parameter focus to "Range".
- (2) Press **Range** to switch the current working range. You can also use the Left/Right arrow key or the knob to switch it.

Note:

- The low range provides better resolution and accuracy at low current settings.
- If the set current value is greater than the maximum value of the low range, you must select a high range.



CAUTION

Before switching the range, please disable the channel input to avoid causing damage to the instrument or the battery.

Set V_Stop

When the cut-off voltage is set to the termination condition, after the battery voltage reaches the cut-off voltage value, the load stops sinking automatically. The battery stops discharging. The default unit for the cut-off voltage is V.

- If you set the cut-off voltage to be the termination condition:

- (1) In the main interface, press **V_Stop** to switch the parameter focus to "V_Stop".
 - (2) Press **V_Stop** to switch to "ON", and select the cut-off voltage to be the termination condition.
 - (3) Enter a value by using the numeric keys, arrow keys, or the knob. For setting methods, refer to the descriptions of the help information or refer to the descriptions in "**Parameter Setting Method**".
- If you do not need to set the cut-off voltage to be the termination condition:
 - (1) In the main interface, press **V_Stop** to switch the parameter focus to "V_Stop".
 - (2) Press **V_Stop** to switch to "OFF", and the input box is disabled, and you are unable to input any value.

Tip

If the cut-off voltage is set to be the termination condition, when the battery voltage is too low, the system will automatically discontinue test once it confirms that the battery reaches the set value.

Set C_Stop

When the battery capacity is set to the termination condition, after the battery capacity reaches the set value, the load stops sinking automatically. The battery stops discharging. The default unit is mAh.

- If you set the battery capacity to be the termination condition:
 - (1) In the main interface, press **C_Stop** to switch the parameter focus to "C_Stop".
 - (2) Press **C_Stop** to switch to "ON", and select the battery capacity to be the termination condition.
 - (3) Enter a value by using the numeric keys, arrow keys, or the knob. For setting methods, refer to the descriptions of the help information or refer to the descriptions in "**Parameter Setting Method**".
- If you do not need to set the battery capacity to be the termination condition:
 - (1) In the main interface, press **C_Stop** to switch the parameter focus to "C_Stop".
 - (2) Press **C_Stop** to switch to "OFF", and the input box is disabled, and you are unable to input any value.

Set T_Stop

When the discharge time is set to the termination condition, after the discharge time reaches the set value, the load stops sinking automatically. The battery stops discharging. The default unit for the discharge time is s.

- If you set the discharge time to be the termination condition:
 - (1) In the main interface, press **T_Stop** to switch the parameter focus to

"T_Stop".

- (2) Press **T_Stop** to switch to "ON", and select the discharge time to be the termination condition.
 - (3) Enter a value by using the numeric keys, arrow keys, or the knob. For the setting methods, refer to the descriptions of the built-in help information or refer to the descriptions in "**Parameter Setting Method**".
- If you do not need to set the discharge time to be the termination condition:
 - (1) In the main interface, press **T_Stop** to switch the parameter focus to "T_Stop".
 - (2) Press **T_Stop** to switch to "OFF", and the input box is disabled, and you are unable to input any value.

Set Von

When the input voltage is greater than the set starting voltage (Von), the load starts to sink the current. The default unit for Von is V, and it ranges from 0 V to 150 V. The default Von is 0.5 V. To enable or disable this function, refer to descriptions in "**Enable/Disable the Von Latch Function**".

- (1) In the main interface, press **Von** to switch the parameter focus to "Von".
- (2) Enter a value by using the numeric keys, arrow keys, or the knob. For setting methods, refer to the descriptions of the help information or refer to the descriptions in "**Parameter Setting Method**".

4. Turn on the channel input

Press **On/Off** to turn on the channel input. At this time, the actual current, discharge voltage, current discharge time, discharged capacitance, and battery energy will be displayed in the main interface.

If the termination condition for the battery discharge is met, after completing the test, a prompt message is displayed, "Battery test completed!" Press **OK** to exit.

Note: Once the channel input is turned on, the load will not start to sink the current until the input voltage is greater than the starting voltage.



WARNING

To avoid electric shock, ensure that the battery is connected to the input terminals of the load properly before you turn on the channel input.

5. View waveform display

Press the **waveform display key**  to enter the waveform display interface, as shown in Figure 2-38. By default, it displays the current waveform. When you select "I" under "Data", the battery is discharged in CC mode. For detailed operation, refer to descriptions in "**Waveform Display Function**". Press the

waveform display key  again to exit the waveform display interface and return to the main interface of Battery test function.

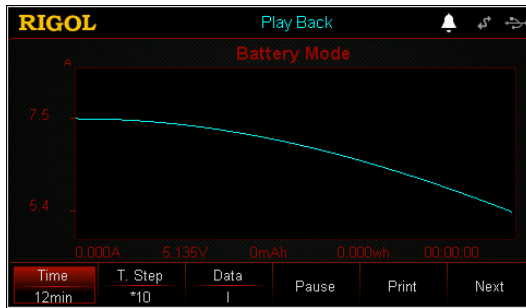

Figure 2-38 Battery Waveform Display Interface

6. Exit the battery test function

Press any key on the front panel of the load to exit the battery test function.

Advanced Function

The advanced functions include factory test function and CC+CV function. Press **Option** to enter the advanced function interface, as shown in Figure 2-39.

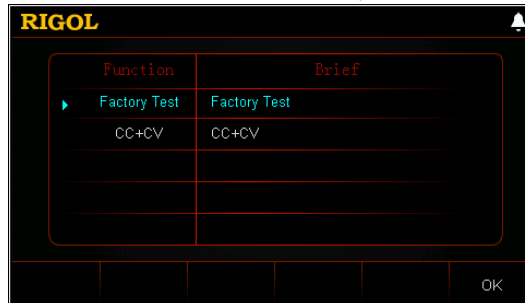

Figure 2-39 Option Interface

Factory Test Function

In CC/CV mode, the load supports the factory test function, which is used to test the stability of the current and voltage of the DUT.

Operation Procedures:

1. Power on the instrument

Press the **Power** key  on the front panel to power on the instrument.

2. Connect the DUT and the channel input terminals of the load

Connect the DUT and the channel input terminals on the front panel of the load as shown in Figure 2-2.



CAUTION

While making a connection, the positive polarity of the load should be connected to the (+) terminal of the channel output, and the negative polarity of the load to the (-) terminal of the channel output. A misconnection with the terminals may cause damage to the instrument or the DUT.

3. Set channel parameters

Press **Option** to enter the advanced function interface. Press **OK** or **OK** to enter the main interface of factory test function, as shown in Figure 2-40. "Factory" is displayed at the top of the main interface.

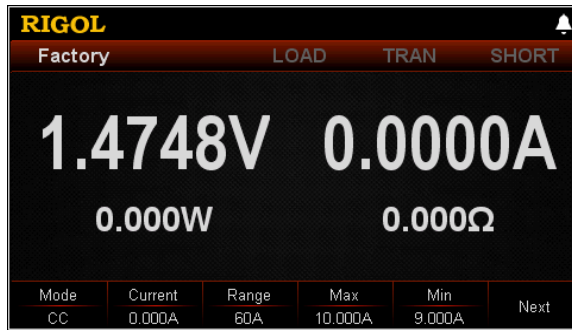

Figure 2-40 Main Interface of Factory Test Function

The menus of the main interface are displayed in two pages.

Menu items on Page 1: Mode, Current, Range, Max, Min, and Next.

Menu items on Page 2: Pass_Tip, Fail_Tip, Pass_Sound, Fail_Sound, and Back.

To go to the next page, press **Next**; to exit the current page and go back to the previous page, press **Back**.

Set Mode

Factory test function supports CC/CV mode.

- (1) In the main interface, press **Mode** to switch the parameter focus to "Mode".
- (2) Press **Mode** to switch the factory test mode. You can also use the Left/Right arrow key or the knob to switch it.

Set Current/Voltage

Sets the working voltage or current in the current mode based on the currently selected working mode for the factory test function. The default unit for the current is A, and that for the voltage is V.

- If you select "CC" mode:
 - (1) In the main interface, press **Current** to switch the parameter focus to "Current".
 - (2) Enter a value by using the numeric keys, arrow keys, or the knob. For setting methods, refer to the descriptions of the help information or refer to the descriptions in "**Parameter Setting Method**".
- If you select "CV" mode:
 - (1) In the main interface, press **Voltage** to switch the parameter focus to "Voltage".
 - (2) Enter a value by using the numeric keys, arrow keys, or the knob. For setting methods, refer to the descriptions of the help information or refer to the descriptions in "**Parameter Setting Method**".

Set Range

Sets the range in the current mode based on the currently selected working mode of the factory test function.

- If you select "CC" mode:

- (1) In the main interface, press **Range** to switch the parameter focus to "Range".
 - (2) Press **Range** to switch the current working range. You can also use the Left/Right arrow key or the knob to switch it.
- If you select "CV" mode:
 - (1) In the main interface, press **Range** to switch the parameter focus to "Range".
 - (2) Press **Range** to switch the voltage working range. You can also use the Left/Right arrow key or the knob to switch it.

Note:

- The low range provides better resolution and accuracy at low current or voltage settings.
- If the set current or voltage value is greater than the maximum value of the low range, you must select a high range.

**CAUTION**

Before switching the current range, please disable the channel input to avoid causing damage to the instrument or the DUT.

Set Max

Sets the upper limit of the working voltage or current in the current mode based on the currently selected working mode for the factory test function.

- (1) In the main interface, press **Max** to switch the parameter focus to "Max".
- (2) Enter a value by using the numeric keys, arrow keys, or the knob. For setting methods, refer to the descriptions of the help information or refer to the descriptions in "**Parameter Setting Method**".

Set Min

Sets the lower limit of the working voltage or current in the current mode based on the currently selected working mode for the factory test function.

- (1) In the main interface, press **Min** to switch the parameter focus to "Min".
- (2) Enter a value by using the numeric keys, arrow keys, or the knob. For setting methods, refer to the descriptions of the help information or refer to the descriptions in "**Parameter Setting Method**".

Set Pass_Tip

If the test is passed, you can determine whether to display the prompt message that reports the test pass.

- (1) In the main interface, press **Pass_Tip** to switch the parameter focus to "Pass_Tip".
- (2) Press **Pass_Tip** to enable or disable the display of the prompt message. You can also use the Left/Right arrow key or the knob to switch the on/off state.

Set Fail_Tip

If the test is failed, you can determine whether to display the prompt message that indicates the test failure.

- (1) In the main interface, press **Fail_Tip** to switch the parameter focus to "Fail_Tip".
- (2) Press **Fail_Tip** to enable or disable the display of the prompt message. You can also use the Left/Right arrow key or the knob to switch the on/off state.

Set Pass_Sound

If the test is passed, you can determine whether to sound the alarm for test pass.

- (1) In the main interface, press **Pass_Sound** to switch the parameter focus to "Pass_Sound".
- (2) Press **Pass_Sound** to enable or disable the alarm sound once the test is passed. You can also use the Left/Right arrow key or the knob to switch the on/off state.

Set Fail_Sound

If the test is failed, you can determine whether to sound the alarm for test failure.

- (1) In the main interface, press **Fail_Sound** to switch the parameter focus to "Fail_Sound".
- (2) Press **Fail_Sound** to enable or disable the alarm sound once the test is failed. You can also use the Left/Right arrow key or the knob to switch the on/off state.

4. Turn on the channel input

Press **On/Off** to turn on the channel input for the factory test function. At this time, the actual input voltage, current, resistance, and power will be displayed in the main interface.



WARNING

To avoid electric shock, ensure that the DUT is connected to the input terminals of the load properly before you turn on the channel input.



CAUTION

When the fan stops working, the channel is disabled. Then, a message is displayed, "Fan stops running!"

5. Exit the factory test function

Press any key on the front panel of the load to exit the factory test function.

CC+CV Function

The load supports CC+CV function that simulates two stages of charging: The load is set to be in CC mode and simulates constant current (CC) charging. When the readback voltage is detected and the detected value reaches the preset voltage, the load switches to the CV mode to simulate constant voltage (CV) charging. This function is used to test the charger and similar devices.

Operation Procedures:

1. Power on the instrument

Press the **Power** key  on the front panel to power on the instrument.

2. Connect the DUT and the channel input terminals of the load

Connect the DUT and the channel input terminals on the front panel of the load as shown in Figure 2-2.



CAUTION

While making a connection, the positive polarity of the load should be connected to the (+) terminal of the channel output, and the negative polarity of the load to the (-) terminal of the channel output. A misconnection with the terminals may cause damage to the instrument or the DUT.

3. Set channel parameters

Press **Option** to enter the advanced function interface, and then use the Up/Down arrow keys or the knob to switch to "CC+CV". Press **OK** or **OK** to enter the main interface of CC+CV function, as shown in Figure 2-41. "CC+CV" is displayed at the top of the main interface.

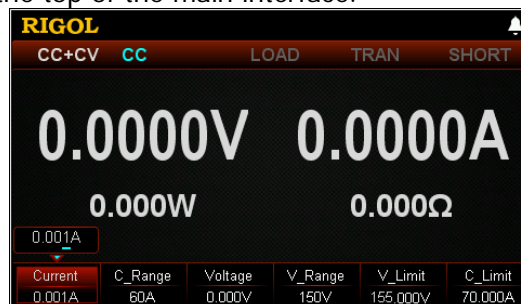

Figure 2-41 Main Interface of CC+CV Mode

In CC+CV mode, you need to set the following parameters: Current, C_Range, Voltage, V_Range, V_Limit, and C_Limit.

Set Current

The constant current in CC+CV mode. The default unit for the current is A.

- (1) In the main interface, press **Current** to switch the parameter focus to "Current".
- (2) Enter a value by using the numeric keys, arrow keys, or the knob. For setting methods, refer to the descriptions of the help information or refer to the descriptions in "**Parameter Setting Method**".

Tip

In CC+CV mode, when the set load current is greater than the current output from the DUT, short circuit occurs to the DUT.

Set C_Range

The working ranges of current in CC+CV mode are as follows. Different models have different ranges.

DL3021/DL3021A: low range (0 to 4 A); high range (0 to 40 A)

DL3031/DL3031A: low range (0 to 6 A); high range (0 to 60 A)

- (1) In the main interface, press **C_Range** to switch the parameter focus to "C_Range".
- (2) Press **C_Range** to switch the current working range. You can also use the Left/Right arrow key or the knob to switch it.

Note:

- The low range provides better resolution and accuracy at low current settings.
- If the set current value is greater than the maximum value of the low range, you must select a high range.



CAUTION

Before switching the current range, please disable the channel input to avoid causing damage to the instrument or the DUT.

Set Voltage

The constant voltage in CC+CV mode. The default unit for the voltage is V.

- (1) In the main interface, press **Voltage** to switch the parameter focus to "Voltage".
- (2) Enter a value by using the numeric keys, arrow keys, or the knob. For setting methods, refer to the descriptions of the help information or refer to the descriptions in "**Parameter Setting Method**".

Tip

In CC+CV mode, when the set load voltage is greater than the voltage output from the DUT, broken circuit occurs to the DUT.

Set V_Range

Working range for the voltage in CC+CV mode. Two ranges are available: low range

(0-15 V) and high range (0-150 V).

- (1) In the main interface, press **V_Range** to switch the parameter focus to "V_Range".
- (2) Press **V_Range** to switch the voltage working range. You can also use the Left/Right arrow key or the knob to switch it.

Note:

- The low range provides better resolution and accuracy at low voltage settings.
- If the set current value is greater than the maximum value of the low range, you must select a high range.



CAUTION

Before switching the voltage range, please disable the channel input to avoid causing damage to the instrument or the DUT.

Set V_Limit

The upper limit of the voltage working in CC+CV mode. The default unit for V_Limit is V, and it ranges from 0 V to 155 V.

- (1) In the main interface, press **V_Limit** to switch the parameter focus to "V_Limit".
- (2) Enter a value by using the numeric keys, arrow keys, or the knob. For setting methods, refer to the descriptions of the help information or refer to the descriptions in "**Parameter Setting Method**".

Set C_Limit

The upper limit of the current working in CC+CV mode. The default unit for C_Limit is A, and it ranges from 0 A to 70 A.

- (1) In the main interface, press **C_Limit** to switch the parameter focus to "C_Limit".
- (2) Enter a value by using the numeric keys, arrow keys, or the knob. For setting methods, refer to the descriptions of the help information or refer to the descriptions in "**Parameter Setting Method**".

4. Turn on the channel input

Press **On/Off** to turn on the channel input. At this time, the actual input voltage, current, resistance, and power will be displayed in the main interface.



WARNING



To avoid electric shock, ensure that the DUT is connected to the input terminals of the load properly before you turn on the channel input.



CAUTION

When the fan stops working, the channel is disabled. Then, a message is displayed, "Fan stops running!"

5. View waveform display

Press the **waveform display key**  to enter the waveform display interface, as shown in Figure 2-42. For detailed operations, refer to the descriptions in "**Waveform Display Function**" section. Press the **waveform display key**  again to exit the waveform display interface and return to the main interface of CC+CV function.

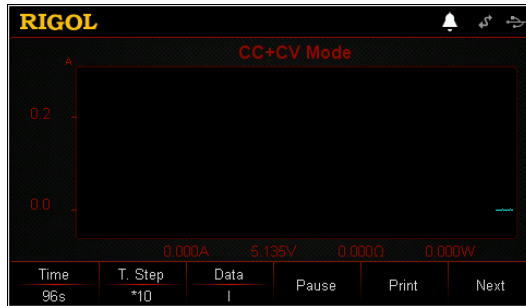

Figure 2-42 CC+CV Waveform Display Interface



6. Exit CC+CV mode

Press any key on the front panel of the load to exit CC+CV mode.

Waveform Display Function

The electronic load provides the waveform display function and supports the following operations for the waveform, such as pausing the waveform, recording the waveform, and capturing the waveform. Therefore, you can dynamically observe the trend of parameters changes.

The waveform display function is applicable to CC/CV/CR/CP/Con/Pul/Tog/Battery/OCP/OPP/CC+CV modes.

In CC/CV/CR/CP/Battery/CC+CV modes, press the **waveform display key**  to enter the waveform display interface. In Con/Pul/Tog/OCP/OPP modes, after you enter the main interface, press the **waveform display key**  to enter the waveform display interface, as shown in Figure 2-43. Figure 2-43 (a) is applicable to CC/CV/CR/CP/Pul/Tog/Battery/OCP/OPP/CC+CV modes (here the figure takes CC mode as an example); Figure 2-43 (b) is only applicable to Con mode.

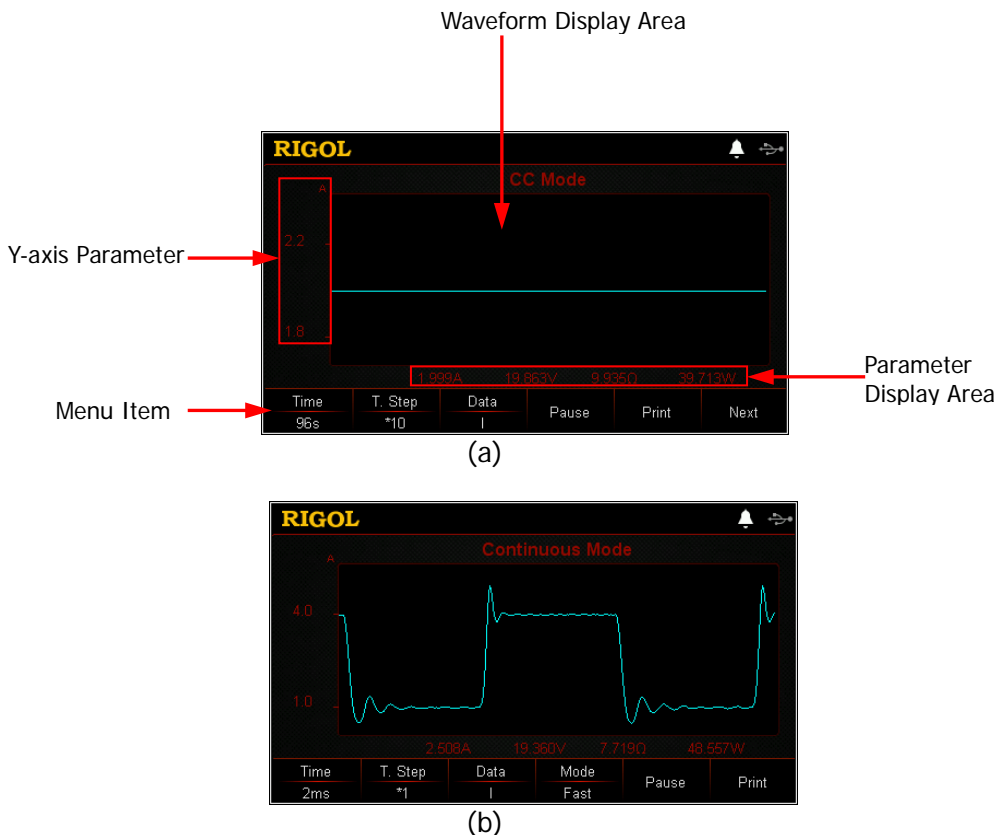



Figure 2-43 Waveform Display Interface

Tip

For the Con/Pul/Tog/OCP/OPP modes, in the guide interface, when you press the **waveform display key** , you cannot enter the waveform display interface.

Only when you enter the main interface, can you press **waveform display key**  to enter the waveform display interface.

Operation Methods:**1. Set Time**

For CC/CV/CR/CP/Pul/Tog/Battery/OCP/OPP/CC+CV modes, the range of the window time is from 8 s to 80 h; for Con mode, its range of the window time is related to the selected mode.

- (1) In the waveform display interface, press **Time** to switch the parameter focus to "Time".
- (2) Enter a value by using the numeric keys. While entering a name, press  to delete the unwanted character if necessary.
- (3) Press the specified menu key to select the unit to s, min, or h.

In addition, you can use the arrow keys or the knob to set the time value, and the value can be increased or decreased at a specified step.

Tip

When the time that you set is greater than 120 s, it will be automatically displayed in minute; when greater than 120 min, it will be automatically displayed in hour.

2. Set T. Step

The time step scale includes *1 and *10. When the time step is set to "*1", it indicates that the window time increases or decreases with a step size of 1; when the time step is set to "*10", it indicates that the window time increases or decreases with a step size of 10.

- (1) In the waveform display interface, press **T. Step** to switch the parameter focus to "T. Step".
- (2) Press **T. Step** to switch the time step scale. You can also use the Left/Right arrow key or the knob to switch it.

Tip

When the window time unit is s, the time step scale *1 is not supported.

3. Data

Press **Data** to display different waveforms of the item displayed in the vertical axis. You can also press the Left/Right arrow key or rotate the knob to switch it.

In CC/CV/CR/CP/Pul/Tog/Battery/OCP/OPP/CC+CV modes, menu items under "Data" include I, U, R, and P. In Con mode, only I and U are included under "Data".

- (1) If "I" is selected to be the menu item under "Data", then the vertical axis indicates the current, and the current waveform is displayed in the interface.
- (2) If "U" is selected to be the menu item under "Data", then the vertical axis indicates the voltage, and the voltage waveform is displayed in the interface.
- (3) If "R" is selected to be the menu item under "Data", then the vertical axis indicates the resistance, and the resistance waveform is displayed in the interface.
- (4) If "P" is selected to be the menu item under "Data", then the vertical axis indicates the power, and the power waveform is displayed in the interface.

4. Mode

Only applicable to Con mode. Press **Mode** to switch the waveform output mode. You can also use the Left/Right arrow key or the knob to switch it. Two modes are available: Fast and Roll.

- Fast: Displays trends of parameter changes in the form of high-speed sampling, applicable to the waveforms with great changes.
- Roll: Scrolling displays trends of parameter changes, applicable to the waveforms with small changes.

When you select Fast mode, the window time is displayed in ms, and you cannot set the time value by using the numeric keys, but only with the arrow keys and the knob.

Tip

Fast mode is only available in Con mode for the waveform output. Roll mode is, by default, available for other operation modes.

5. Pause/Start

Press **Pause**, and then the waveform stops outputting. When you press the **Start** key again, the waveform restores to output again.

6. Print

After you insert the USB storage device, press **Print** to capture the screen or images and save them in ".BMP" format to the USB storage device. Meanwhile, save the corresponding data file in CSV format.

7. Record

After you insert the USB storage device, press **Record** to save the data file automatically to the external memory in CSV format. During recording, "Record" is displayed at the top of the interface. Press **Record** again to stop recording,

and then "Record" is not displayed at the top of the interface.

Tip

- During recording, the filename of the data file is generated automatically.
- In Battery mode, in addition to recording regular data, such as current and voltage, the data file records the "mAh"(battery discharge capacity), "wh" (battery discharge watt-hour) and "time"(battery discharge time).

8. Play Back

After you insert the USB storage device, press **Play Back** to play back the recorded data files. During playing back, "Play Back" is displayed at the top of the interface. Press **Play Back** again to stop playing back, and then "Play Back" is not displayed at the top of the interface.

- (1) After recording, press **Play Back** to enter the recording and playing back interface.
- (2) Use the arrow keys or the knob to locate the path of Disk D.
- (3) Press **Cursor** to switch to the file and select the CSV data file that you want to play back.
- (4) Press **Read**, and then the load will read the currently selected data file and display it in the waveform display interface.

Tip

When the recording function is enabled, the playback function is disabled; when the playback function is enabled, the recording function is disabled.

9. Set Start Point

When playing back the data file, you can set the start point for playing back.

- (1) In the waveform display interface, press **Start Point** to switch the parameter focus to "Start Point".
- (2) Enter a value by using the numeric keys. While entering a name, press  to delete the unwanted character if necessary.
- (3) Press **OK** to confirm it.

In addition, you can use the arrow keys or the knob to set the start point, and the value can be increased or decreased with a step size of 1 or 10. When time step is set to "*1", it indicates that the value of start point increases or decreases with a step size of 1; when set to "*10", it indicates that the value of start point increases or decreases with a step size of 10.

10. Return to the main interface

Press the **waveform display key**  again to exit the waveform display interface and return to the main interface.

Note: If you press any other key on the front panel of the load, the input will be automatically turned off.

Input Control

Turn On/Off the Input

Once you power on the load, it will not sink the current immediately, and you need to press the **ON/OFF** key to control the input of the load. When the input of the load is enabled, the **ON/OFF** key is illuminated. At this time, when the load reaches the starting voltage (V_{on}), the load starts to sink the current. Then, "LOAD" at the top of the main interface is highlighted and active. When the input of the load is disabled, the **ON/OFF** key is not illuminated. At this time, the load stops sinking the current. Then, "LOAD" at the top of the main interface is inactive and grayed out.

Tip

Enabling or disabling the input does not affect the set values of the current parameters.

Von Latch Function

When the load is used to test the power supply product whose voltage rises or falls at a relatively slow rate, latched protection may occur. The load provides the Von Latch function. You can set V_{on} to control the sinking function of the load, thus protecting the DUT. The starting voltage is set in CC, Battery, OCP and OPP modes. The default unit for V_{on} is V, and it ranges from 0 V to 150 V.

- **Enable the Von Latch Function**

When the input voltage is greater than the set starting voltage (V_{on}), the load starts to sink the current. When the input voltage decreases and reaches below the set starting voltage (V_{on}), the load will not stop sinking the current. As shown in Figure 2-44.

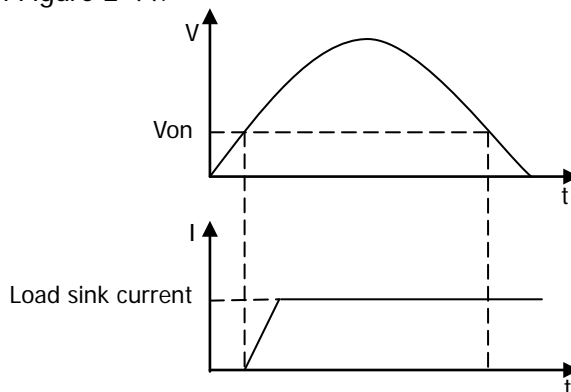

Figure 2-44 Enable the Von Latched Function

- **Disable the Von Latch Function**

When the input voltage is greater than the set starting voltage (V_{on}), the load starts to sink the current. When the input voltage decreases and reaches below the set starting voltage (V_{on}), the load will stop sinking the current. As shown in Figure 2-45.

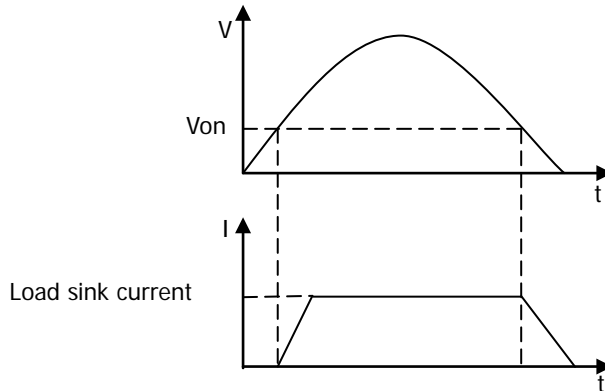

Figure 2-45 Disable the Von Latched Function

Tip

If the load cannot sink the current, please check whether the starting voltage (V_{on}) has been set. If set, please set it to a minimum value.

Short-circuit Operation

The load can serve as a short-circuit system at the input terminal to test whether the protection function of the DUT is normal when a short circuit occurs to the output terminal of the DUT.

Press **SHORT** on the front panel of the load to cause the load to stay in short-circuited state. At this time, the **SHORT** key is illuminated, which indicates that short circuit function is enabled, and the load is in short-circuited state. "SHORT" at the top of the main interface is highlighted and active. When the **SHORT** key is not illuminated, short circuit function is disabled. At this time, "SHORT" at the top of the main interface is grayed out and inactive.

When a short circuit occurs to the load in non-CC mode, it will automatically be switched to its original mode. The maximum short-circuit current for DL3021/DL3021A is 44 A; and that for DL3031/DL3031A is 64 A.

Note: Enabling the short circuit function in CV mode may cause the load to sink large amounts of current, which may turn the input off.

Tip

Turning the short circuit on does not affect the set values of the current parameters, and the load will return to the previously set state when the short circuit is turned off.

Trigger Operation

Trigger operation is commonly used in transient test function (Con, Pul, and Tog) and List function. The load supports three triggering modes to allow synchronization with other DUT. They are Tran trigger, Bus trigger, and DIGIO trigger. Before enabling the trigger function, please select a trigger type first.

- **Transient Trigger (TRAN)**

In the local operation mode, press the **TRAN** key on the front panel, and then one trigger operation is executed. At this time, "TRAN" at the top of the main interface is highlighted and active.

- **Bus Trigger (BUS)**

When the load receives the remote triggering command (:TRIG:IMM) via the interface, the load will perform one trigger operation.

- **Digital I/O Trigger (DIGIO)**

The digital I/O interface on the rear panel of the load can be used to receive the external trigger signal. When the external trigger is in effect, the load will perform one trigger operation once a low pulse is received over the trigger terminal. The trigger output signal over the digital I/O interface can be used to trigger an external device, such as a digital oscilloscope, an electronic load, and other products.

Slew Rate and Minimum Transition Time

Slew rate is defined as the change in current, resistance, or voltage over time. It is the speed of transition from one setting to another. You can set the actual transition time from one setting to another by changing the slew rate. Figure 2-46 shows the relationship between the set slew rate and the transition time. The slew rate determines the minimum transition time between two settings. When the slew rate is set to be a maximum value, it indicates that the transition time between the two settings is the smallest.

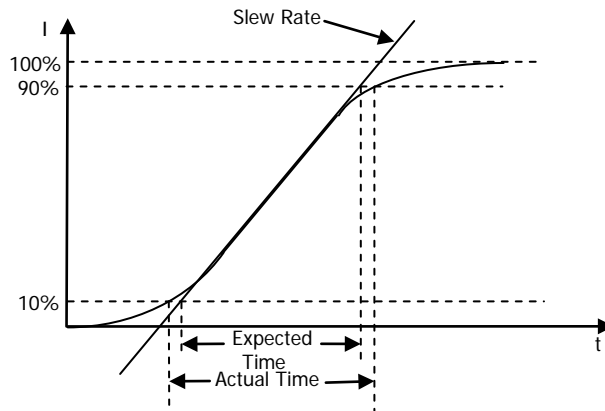

Figure 2-46 Slew Rate and Transition Time

Note: In case where the transition from one setting to another is large, the minimum transition time can be calculated by dividing the current transition by the slew rate. In case where the transition from one setting to another is small, the small signal bandwidth of the load limits the minimum transition time. Due to the limitation, the actual transition time is longer than the expected time calculated based on the formula.

Tip

The actual transition time is defined as the time required for the input to change from 10% to 90% or from 90% to 10% of the input values.

Protection Function

The load includes the following protection features: overcurrent protection (OCP), overvoltage protection (OVP), overpower protection (OPP), overtemperature protection (OTP), as well as local/remote reverse voltage (LRV/RRV) protection. Once any of the above conditions is detected, the load will take the corresponding protection measures and enter its self-protection mode.



CAUTION

To avoid causing damage to the load, the input voltage shall not exceed the maximum rated input voltage, and the AC voltage is not allowed to be connected to the load via the channel input terminals.

- **Overcurrent Protection (OCP)**

When the current that the load sinks exceeds the protection current, the load's input will be automatically turned off and the load will stop sinking the current. At this time, the beeper sounds, and a prompt message is displayed, "Overcurrent protection, input disabled!" You can press **OK** to exit the prompt message.

- **Overvoltage Protection (OVP)**

When the input voltage exceeds the protection voltage, the load's input will be automatically turned off and the load will stop sinking the current. At this time, the beeper sounds, and a prompt message is displayed, "Overvoltage protection, input disabled!" You can press **OK** to exit the prompt message.

- **Overpower Protection (OPP)**

Overpower protection feature is mainly designed for protecting hardware. It prevents the elements from being remained in the overpower state for a long time, as doing so may cause the elements to quickly get aged or even damaged.

When the input power exceeds the protection power, the load's input will be automatically turned off and the load will stop sinking the current. At this time, the beeper sounds, and a prompt message is displayed, "Overpower protection, input disabled!" You can press **OK** to exit the prompt message.

- **Overtemperature (OTP)**

The load has an overtemperature protection circuit. When the internal temperature exceeds the safe limits, the load's input will be automatically turned off and the load will stop sinking the current. At this time, the beeper sounds, and a prompt message is displayed, "Overtemperature protection, input disabled!". You can press **OK** to exit the prompt message.

- **Reverse Voltage Protection (LRV/RRV)**

When the polarity of input terminals (except the Sense terminals) and that of

the output terminals of the DUT are in wrong connection, the load's input will be automatically turned off and the load will stop sinking the current. At this time, the beeper sounds, and a prompt message is displayed, "Reverse connection!" You can press **OK** to exit the prompt message.

Note: If the reverse current exceeds the rated current, the load may be damaged.



CAUTION

To avoid causing damage to the load, when reverse voltage occurs, you need to turn off the DUT and the load first, and then make a right polarity connection.

Sense Working Mode

When the DUT outputs great currents, the voltage drop on the load leads cannot be ignored. To ensure an accurate measurement for the output voltage of the DUT, the load provides Sense (remote sense) working mode.

In this mode, the Sense terminals are directly connected to the output terminals of the DUT. Remote sensing compensates for the voltage drop caused by the load leads, ensuring that the output voltage of the DUT is consistent with the input voltage of the load.

Figure 2-47 shows the Sense connections on the front panel.

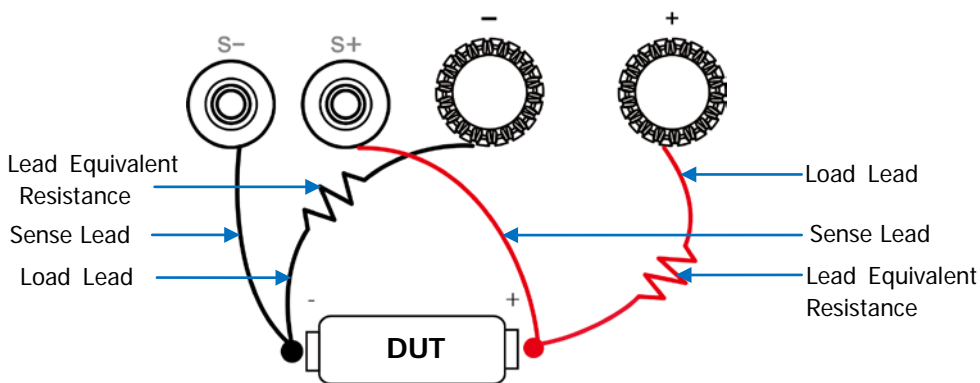

Figure 2-47 Sense Connections

Operation Procedures:

1. As shown in the above figure, connect the positive terminal on the front panel of the load to the positive polarity (+) of the DUT; the positive terminal of the Sense (S+) to the positive polarity (+) of the DUT. Connect the negative terminal on the front panel of the load to the negative polarity (-) of the DUT; the negative terminal of the Sense (S-) to the negative polarity (-) of the DUT. Do not make a wrong connection.
2. Press **Utility** to enter the system utility function interface. In the "System" tab, press the Up/Down arrow key to switch the parameter focus to "Sense", and then press the Left/Right arrow key or use the knob to enable or disable the Sense function.

Note: After you enable the Sense function, if the Sense terminals are not connected to the output terminals of the DUT, then the load cannot accurately measure the voltage of the terminals in any functions.

Tip

- In case where the DUT outputs great currents, the load leads should be as short as possible. You'd better twisted the leads to get optimum output.
- Twisted-pair wires are recommended for Sense leads, but you'd better not twist the Sense leads with the load leads.

Function of Terminals on the Rear Panel

External Trigger Function

If you select the trigger signal over the digital I/O interface on the rear panel of the load, first select "DIGIO" to be the trigger source of the load. For details, refer to descriptions in "Trigger Operation".

Current/Voltage Monitoring Function

The load provides voltage monitoring output connector (Vmon OUT) and current monitoring output connector (Imon OUT) on the rear panel of the load. A 0-to-10 V voltage output signal at the connector indicates the zero-to-full scale input current or voltage. The input voltage and current are directly proportional to the output voltage.

The current/voltage monitoring function enables you to use the external DVM or oscilloscope to monitor the input current/voltage.

Store and Recall

The load allows you to save different types of files to the internal and external memories. You can recall and read them when necessary.

The load provides an internal non-volatile memory (Disk C) and an external memory (Disk D). Disk D is only available when a USB storage device is detected over the USB HOST interface on the front panel.

Note: The load only supports FAT32 USB flash drives.

1. Disk C

You can save the currently set state files, Con/Pul/Tog/List/OCP/OPP files, and system log files to Disk C. At most 100 files can be save to Disk C.

- (1) State file: includes the current system setting of the load, its interface settings, and current mode.
- (2) Con/Pul/Tog/List/OCP/OPP file: includes the settings in Con/Pul/Tog/List/OCP/OPP mode.
- (3) System log file: includes key values (up to 100 key values can be saved) and the prompt messages.

2. Disk D

Disk D is only available when a USB storage device is detected over the USB HOST interface on the front panel. You can save the currently set state files and data files of various function modes to the USB storage device, and you can also copy the files from Disk C to Disk D. The number of files that can be saved is determined by the storage space of the disk.

Press **Store** on the front panel of the load to enter the storage and recall interface, as shown in Figure 2-48.

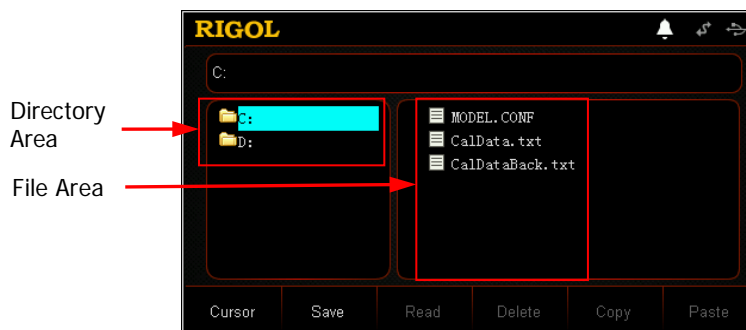

Figure 2-48 Storage and Recall Interface

Cursor

Operation Procedures:

1. Press **Store** on the front panel of the load to enter the storage and recall interface.
2. Press **Cursor** to switch between the directory and the file.
3. Use the knob or press the Up/Down arrow key to select the desired directory or file.

Save

Operation Procedures:

1. Press **Store** on the front panel of the load to enter the storage and recall interface. Then, press **Cursor** to select a desired directory.
2. Press **Save** to enter the filename input interface. By default, the input type is lowercase English letters, as shown in Figure 2-49.

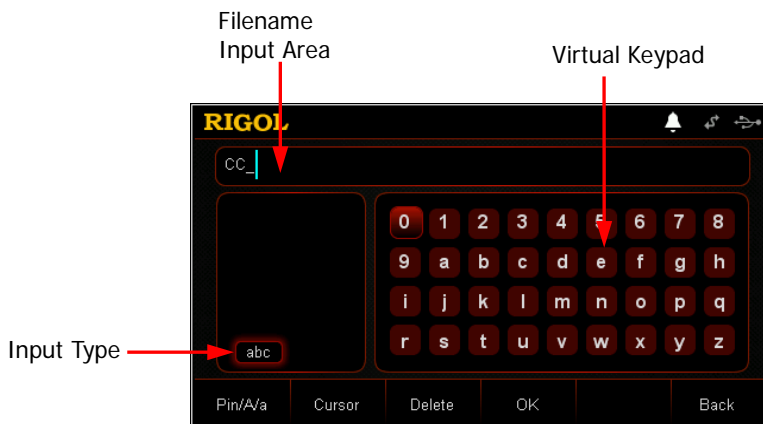



Figure 2-49 Filename Input Interface (lowercase English letters)

3. Enter a file name.
In the filename input interface, press **Pin/A/a** to select one of the three input types (Pinyin, uppercase English letters, and lowercase English letters).
- Pinyin:
When using Pinyin input method (as shown in Figure 2-50) to input the filename, use the arrow keys or the knob to select the desired letter(s) and then press **OK**, the selected letter(s) is/are displayed in the "Pinyin Input Area". (At this time, if you want to use the input English letters as the filename, you can press the numerical key **0** on the front panel of the load, and then the English letters that you input in the "Pinyin Input Area" are displayed in the filename input area. This example takes the CC mode

as an example, therefore, the filename takes "CC_" as the prefix.) After you input Pinyin for a Chinese character, use the numerical key on the front panel to select the number that corresponds to the desired Chinese character in the "Chinese Character Selection Area", and then the selected Chinese character will be displayed in the "Filename Input Area". (**Note:** If not all characters are not fully displayed in the "Pinyin Input Area", press **Cursor**. Then, when the downward arrow key is highlighted, you can press the Up/Down arrow key on the front panel to search for the desired character by paging up or down.) Use the same method to input other Chinese characters for the filename.

The length of the filename is limited to 30 characters. (**Note:** One Chinese character is seen as a string of two characters.) While inputting the filename, you can continuously press **Delete** or the Backspace key  to delete the unnecessary letters in the "Pinyin Input Area" or the Chinese characters that have been input in the "Filename Input Area".

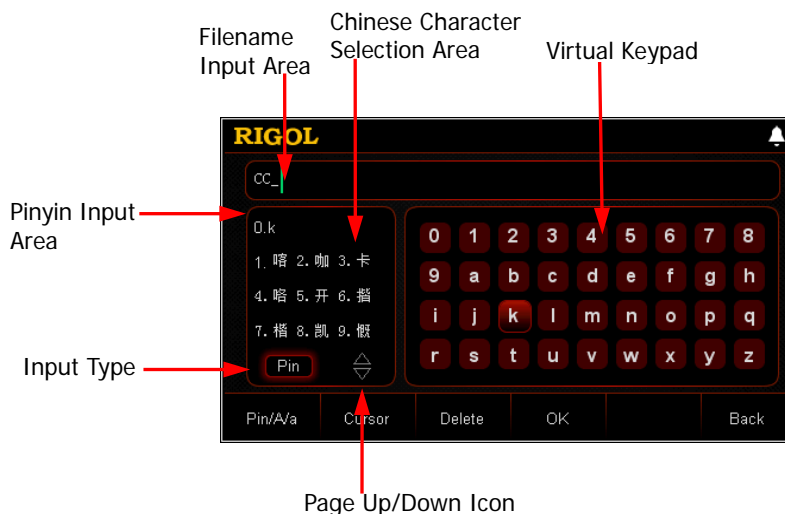

Figure 2-50 Filename Input Interface (Pinyin)

Tip

In the Pinyin input method, use the arrow keys or the knob to select a number in the virtual keypad, then press **OK**. The selected number will be immediately displayed in the "Filename Input Area".

- Uppercase/lowercase English letters (as shown in Figure 2-51):
You can switch the letter input method to select whether to input the English letters in uppercase form or lowercase form. Use the arrow keys or the knob to select the desired English letter in the virtual keypad, and then press **OK**. The selected letter will be displayed in the "Filename Input Area". Use the same method to input other English letters for the filename.

The length of the filename is limited to 30 characters. While inputting the filename, you can continuously press **Delete** or the Backspace key  to delete the unnecessary letters that have been input in the "Filename Input Area".



Figure 2-51 Filename Input Interface (uppercase English letters)

Note: The numeric input is supported for the above three input methods (Pinyin, Uppercase English letter, Lowercase English letter).

Tip

In the uppercase/lowercase English letter input method, use the arrow keys or the knob to select a number in the virtual keypad, then press **OK**. The selected number will be immediately displayed in the "Filename Input Area".

- After inputting the filename, press **OK**. Then, the file will be saved to the currently selected path with its specified filename and file type. If a valid file has already existed in the currently selected path, a prompt message "Overwrite the existing file?" will be displayed. Press **OK** to overwrite the existing file; press **Cancel** to give up saving the file, and then you will re-enter the filename input interface.

Read

Operation Procedures:

- Press **Store** on the front panel of the load to enter the storage and recall interface.
- Press **Cursor** to switch to the directory, and select the directory where the file to be read, and then press **Cursor** again to select the file to be read.
- Press **Read**, and then the load will read the currently selected file. If no file has been save in this location or the file format cannot be recognized, a prompt message "Failed to read the file!" is displayed. After reading the file successfully,

the load will enter its corresponding interface. (**Note:** The load will enter the guide interface (if any) first.)

Delete

You can delete the files in Disk C and D, as well as the empty folders in Disk D.

Operation Procedures:

1. Press **Store** on the front panel of the load to enter the storage and recall interface.
2. Press **Cursor** to switch to the directory, and select the directory where the file to be deleted, and then press **Cursor** again to select the file to be deleted or select the empty folder.
3. Press **Delete**, and then a prompt message "Delete the file?" is displayed. You can press **OK** to delete the currently selected file or the empty folder; press **Cancel** to give up deleting files or folders.

Copy and Paste

You are only allowed to copy the files from Disk C and paste them to Disk D.

Operation Procedures:

1. Press **Store** on the front panel of the load to enter the storage and recall interface.
2. Press **Cursor** to switch to the directory and select Disk C, and then press **Cursor** again to select the file to be copied.
3. Press **Copy** to copy the currently selected file.
4. Press **Cursor** to switch to the directory and select Disk D.
5. Press **Paste** to paste the copied file to Disk D. After you successfully completed the copy and paste operation, a prompt message "Files copied successfully!" is displayed.

If the same file is found in Disk D, a prompt message "Overwrite the existing file?" is displayed. Press **OK** to overwrite the existing file; press **Cancel** to give up the pasting operation.

System Utility Function

Press **Utility** to enter the system utility function interface, as shown in Figure 2-52.



Figure 2-52 System Utility Function Interface

The following table lists names of different tabs and their descriptions. You can view the information contained in each tab and the parameters that can be set.

Table 2-1 Tab Descriptions

No.	Name	Description
1	System	System setting tab. Sets the system language, power-on, screen brightness, beeper on/off, Sense function on/off, log, etc.
2	Interface	Communication interface setting tab. Configures parameters for remote communication interfaces (GPIB/USB/RS232/LAN).
3	System Info	System information tab. Displays manufacturer, device model, software and hardware version number, etc.
4	Reset	System reset tab. Restores the instrument settings to its factory default settings,
5	Option	System option tab. View the option installation information and install the options.

Tip
If you press **Utility** while the load input is enabled, the load will automatically disable the input and then enter the system utility function interface.

System

Press **Utility** to enter the system utility function interface. By default, the system setting tab is selected. As shown in Figure 2-52, if the scrollbar is shown at the right side of the interface, it indicates that not all system settings are displayed in the current interface. At this time, press the Up/Down arrow key to go to the next page.

Select the System Language

The interface display, help information, and prompt messages are displayed in both Simplified Chinese and English. The setting is stored in the non-volatile memory, which will not be affected even if you restore the load to its factory defaults.

In the system setting tab, press the Up/Down arrow key to switch the parameter focus to "Language", and then press the Left/Right arrow key or use the knob to select the desired language: Chinese or English.

Select the Power-on Value

Select "Default" or "Last" as the power-on system state.

- Default: restores factory defaults when the instrument is powered on, refer to Table 2-3.
- Last: restores its last state when the instrument is powered on.

In the system setting tab, press the Up/Down arrow key to switch the parameter focus to "Power-on", and then press the Left/Right arrow key or use the knob to select the desired power-on state: Default or Last. The setting is saved to the internal non-volatile memory.

Turn On/Off the Beeper

When the beeper is turned on, the  icon is displayed in the status bar. The beeper sounds when you perform the following operations.

- When you press the keys on the front panel;
- When you rotate the knob;
- When a prompt message or an alarm is displayed;
- When the test is passed or failed.

In the system setting tab, press the Up/Down arrow key to switch the parameter focus to "Beeper", and then press the Left/Right arrow key or use the knob to turn on or off the beeper.

Set Digital Input/Output

A digital I/O interface on the rear panel of the load, supporting digital trigger input and trigger output.

- **Digital input**

The digital input is the Edge trigger, supporting triggering on the rising or falling edge. The data line of the Digital I/O interface can receive the external trigger signal. Once the pre-set trigger conditions are met, the input channel is turned on or off (ON/OFF), enabling or disabling the trigger function (TRAN). To avoid misoperation, if you do not need this function, select "Disable" to disable the function.

In the system setting tab, press the Up/Down arrow key to switch the parameter focus to "Digital In", and then press the Left/Right arrow key or use the knob to set it to be "ON/OFF", "TRAN", or "Disable".

Note:

- The TRAN function as the digital input is only valid in the following modes: Con, Pul, Tog, and List.
- The interval between the changes of two voltages for the digital input should be greater than 200 ms.

- **Digital output**

The digital output is a level signal, and the signal can be used for Edge trigger. When the input channel is turned on or off (ON/OFF), and the trigger function is enabled or disabled (TRAN), the data line of the digital I/O interface outputs the level. To avoid misoperation, if you do not need this function, select "Disable" to disable the function.

In the system setting tab, press the Up/Down arrow key to switch the parameter focus to "Digital Out", and then press the Left/Right arrow key or use the knob to set it to be "ON/OFF", "TRAN", or "Disable".

Note:

- The TRAN function as the digital output is only valid in the following modes: Con, Pul, Tog, and List.
- Setting the digital output to be "Disable", if the OCP/OPP test is successful, the digital output is 0; if the OCP/OPP test fails, the digital output of 1.

Enable/Disable the Sense Function

When the DUT outputs large current, after you enable the Sense function, the sense terminal can be used to accurately measure the voltage across the output terminals of the DUT to compensate for the voltage drop on the load.

In the system setting tab, press the Up/Down arrow key to switch the parameter focus to "Sense", and then press the Left/Right arrow key or use the knob to enable or disable the Sense function.

Turn On/Off Voltage Monitoring Output Terminal

The terminal outputs the 0-to-+10 V voltage signal, which indicates the zero-to-full scale real-time input voltage.

In the system setting tab, press the Up/Down arrow key to switch the parameter focus to "Vmon_EXT", and then press the Left/Right arrow key or use the knob to enable or disable the voltage monitoring function.

Turn On/Off Current Monitoring Output Terminal

The terminal outputs the 0-to-+10 V voltage signal, which indicates the zero-to-full scale real-time input current.

In the system setting tab, press the Up/Down arrow key to switch the parameter focus to "Imon_EXT", and then press the Left/Right arrow key or use the knob to enable or disable the current monitoring function.

Set the Short Circuit

The load can serve as a short-circuit system at the input terminal. The short circuit can be toggled on/off. You can set the short circuit to be "TOGGLE". You need to press and hold the **SHORT** key on the front panel of the load to enable the short circuit function. Once you release the key, the short circuit function is disabled. If you set the short circuit to be "HOLD", when you press the **SHORT** key on the front panel of the load, the short circuit function is always enabled. When you press the **SHORT** key again, the short circuit function is disabled.

In the system setting tab, press the Up/Down arrow key to switch the parameter focus to "SHORT", and then press the Left/Right arrow key or use the knob to set the short circuit to be "TOGGLE" or "HOLD".

Turn On/Off Log Recording

After you enable the log recording function, the system stores the log recorded (including the key operation and prompt message) to the internal non-volatile memory. Up to 100 log files can be kept in the memory.

In the system setting tab, press the Up/Down arrow key to switch the parameter focus to "Log", and then press the Left/Right arrow key or use the knob to enable or

disable the log function.

Enable/Disable the Von Latch Function

The load provides the Von Latch function. You can set Von to control the sinking function of the load, thus protecting the DUT. This function is applicable to the CC mode, CR mode, and Battery test mode.

In the system setting tab, press the Up/Down arrow key to switch the parameter focus to "Von Latch", and then press the Left/Right arrow key or use the knob to enable or disable the Von Latch function.

Set the Screen Brightness

You can set the screen brightness by using the brightness slider label. Moving left decreases the brightness; and moving right increases the brightness. The setting is stored in the non-volatile memory, which will not be affected even if you restore the load to its factory defaults.

In the system setting tab, press the Up/Down arrow key to switch the parameter focus to "Brightness", and then press the Left/Right arrow key or use the knob to set brightness.

Communication Interface Setting

Press **Utility** to enter the system utility function interface, and then press **Interface** to enter the interface tab. By default, "GPIB" is selected, as shown in Figure 2-53.



Figure 2-53 "GPIB" Tab Interface

The load supports GPIB (extended from the USB-GPIB interface converter), USB, RS232, and LAN. Remote control can be realized via these interfaces. When you select GPIB, RS232, or LAN, please set the parameters for the interface first.

Tip

- When the load is connected to power source, you can also connect/disconnect USB and LAN interfaces.
- GPIB, USB, RS232, and LAN interfaces cannot be used synchronously. Each time, only one type of interface can be used.

Set the GPIB address

Before using the GPIB interface, use the USB-GPIB interface converter to extend the GPIB interface, and then use the GPIB cable to connect the load to the PC.

Procedures for setting the GPIB address are as follows:

- (1) Press **Interface** to enter the communication interface tab. By default, "GPIB" is selected and it is highlighted.
- (2) Use the numeric keys to set the GPIB address.
- (3) Press **OK** to confirm it.

The GPIB address is an integer ranging from 0 to 30. By default, it is 2. The setting is stored in the non-volatile memory, which will not be affected even if you restore the load to its factory defaults.

View USB ID

Use the USB cable to connect the load to the PC via the USB DEVICE interface. Then, the load can be controlled remotely.

Press **Interface** to enter the communication interface tab, and then press the **USB** key to select the "USB" tab, as shown in Figure 2-54.



Figure 2-54 "USB" Tab Interface

In the "USB" interface, the contents of USB ID is read-only. You can only view the ID of the USB, but you are not allowed to edit it.

Set the parameters for the RS232 interface

Use the 9-pin RS232 cable (female-to-female, cross-over) to connect the RS232 interface to the PC, and set the interface parameters (such as baud rate, parity, etc.) that match the PC. Then, you can remotely control the instrument. The RS232 interface is shown in the following figure. For the descriptions of the pins, refer to Table 2-2.

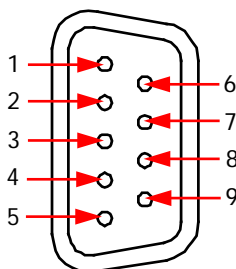

Figure 2-55 RS232 Interface

Table 2-2 Descriptions of RS232 Interface Pins

Pin	Name	Description
1	NC	Not connected
2	TXD (Transmit Data)	Transmit data
3	RXD (Receive Data)	Receives data.

4	NC	Not connected
5	SGND	Signal ground
6	NC	Not connected
7	CTS (Clear To Send)	Clear to send
8	RTS (Request To Send)	Request to send
9	NC	Not connected

Press **Interface** to enter the communication interface tab, and then press the **RS232** key to select the "RS232" tab, as shown in Figure 2-56.

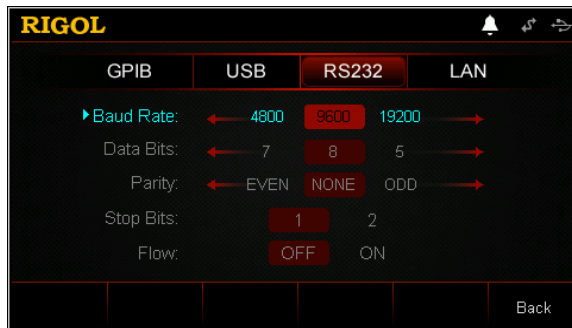

Figure 2-56 RS232 Tab Interface

In the RS232 interface tab, you can set and view the RS232 interface parameters. The setting is stored in the non-volatile memory, which will not be affected even if you restore the load to its factory defaults.

1. Baud Rate

The available baud rates include 4800 bps, 9600 bps, 19200 bps, 38400 bps, 57600 bps, and 115200 bps.

Press the Up/Down arrow key to switch the parameter focus to "Baud Rate", and then press the Left/Right arrow key or use the knob to select the desired baud rate.

2. Data Bits

The available data bits include 5, 6, 7, or 8.

Press the Up/Down arrow key to switch the parameter focus to "Data Bits", and then press the Left/Right arrow key or use the knob to select the desired data bits.

3. Parity

The available parity modes include None, Even, and Odd.

Press the Up/Down arrow key to switch the parameter focus to "Parity", and then press the Left/Right arrow key or use the knob to select the desired parity

mode.

4. Stop Bits

The available stop bits include 1 or 2.

Press the Up/Down arrow key to switch the parameter focus to "Stop Bits", and then press the Left/Right arrow key or use the knob to select the desired stop bits.

5. Flow

The load adopts RTS/CTS hardware flow control mode, and monitors the state of CTS pin. If the state is true, the load sends data; if false, the load stops sending data. When input cache is nearly full, set CTS pin to be "false"; when the input cache is available again, set CTS pin to be "true".

Press the Up/Down arrow key to switch the parameter focus to "Flow", and then press the Left/Right arrow key or use the knob to enable or disable the flow control function.

Set the parameters for the LAN interface

Before using the LAN interface, connect the load to the PC or the local area network (LAN) where the PC resides.

Press **Interface** to enter the communication interface tab, and then press the **LAN** key to select the "LAN" tab to enter the network parameter setting interface, as shown in Figure 2-57.

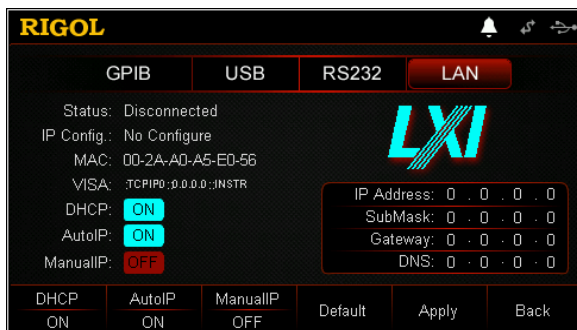

Figure 2-57 "LAN" Tab Interface

In this interface, you can view the network connection status and configure the network parameters such as IP configuration, IP address, subnet mask, and default gateway. The setting is stored in the non-volatile memory, which will not be affected even if you restore the load to its factory defaults.

1. Connection status

The status of the load will be displayed based on the current network connection status.

- Connected: indicates that the network has been successfully connected.
- Disconnected: indicates that the network is disconnected or network connection has failed.
- Configuring Network...: indicates that the network is being configured.
- IP Assignment Failed: indicates being failed to obtain the IP address.
- IP Conflict: indicates that the IP address is conflicted with that of other systems on the network.

2. IP Configuration

There are three types of IP configuration modes:

- DHCP (Dynamic Host Configuration Protocol)
- AutoIP (automatic configuration)
- ManualIP (manual configuration)

In different IP configuration modes, the configurations for IP address and other network parameters are different.

Tip

If the current network connection status is displayed as "Disconnected", then the IP configuration shows "No Configure".

The three IP configuration modes cannot be all set to "ON" or "OFF".

(1) DHCP (Dynamic Host Configuration Protocol)

In this mode, the DHCP server on the current network assigns network parameters (such as the IP address) to the instrument. Press **DHCP** to enable or disable the DHCP configuration mode. By default, it is "ON".

(2) AutoIP (automatic configuration)

In this mode, the instrument acquires the IP address ranging from "169.254.0.1" to "169.254.255.254" and the subnet mask (255.255.0.0) automatically according to the current network configuration. Press **AutoIP** to enable or disable the auto IP configuration mode. By default, it is "ON".

Tip

When DHCP and AutoIP are turned on at the same time, the instrument takes DHCP as the priority. Therefore, if you need to enable the AutoIP mode, please set DHCP to "OFF" first.

(3) ManualIP (manual configuration)

In this mode, you can self-define the network parameters (such as the IP address) of the instrument. Press **ManualIP** to enable or disable the manual IP configuration mode. By default, it is "OFF".

If you enable this mode, "IP Address", "SubMask", "Gateway", and "DNS" at the right section of the interface can be editable.

Tip

If you set "ManualIP" to be "ON", then "DHCP" and "AutoIP" will both be automatically set to "OFF"; if you set "ManualIP" to be "OFF", then "DHCP" and "AutoIP" will both be automatically be set to "ON".

● Set IP Address

In the manual IP mode, you need to acquire an available IP address from the administrator, and then configure the IP address manually. The format of the IP address is "nnn.nnn.nnn.nnn". The range for the first segment (nnn) of the address is from 1 to 223 (except 127); and the range for the other three segments is from 0 to 255.

In the manual IP mode, press the Up/Down arrow key to switch the parameter focus to "IP Address", and then press the Left/Right arrow key to move the cursor. Use the numeric keys or the knob to input the IP address.

The setting is saved to the non-volatile memory. If "Power-on" is set to "Last", and the next you power on the instrument, set both "DHCP" and "AutoIP" to "OFF", in this case, the instrument will automatically load the set IP address.

● Set the subnet mask

In the manual IP mode, you need to acquire an available subnet mask from the administrator, and then configure the subnet mask manually. The format of the subnet mask is "nnn.nnn.nnn.nnn". The range for the first segment (nnn) is from 0 to 255.

In the manual IP mode, press the Up/Down arrow key to switch the parameter focus to "SubMask", and then press the Left/Right arrow key to move the cursor. Use the numeric keys or the knob to input the subnet mask.

The setting is saved to the non-volatile memory. If "Power-on" is set to "Last", and the next you power on the instrument, set both "DHCP" and "AutoIP" to "OFF", in this case, the instrument will automatically load the set subnet mask.

Tip

If the input subnet mask is invalid, a prompt message "Invalid subnet mask. The subnet mask must be contiguous." will be displayed.

- **Set the default gateway**

In the manual IP mode, you need to acquire an available gateway address from the administrator, and then configure the default gateway manually. The format of the default gateway is "nnn.nnn.nnn.nnn". The range for the first segment (nnn) of the address is from 1 to 223 (except 127); and the range for the other three segments is from 0 to 255.

In the manual IP mode, press the Up/Down arrow key to switch the parameter focus to "Gateway", and then press the Left/Right arrow key to move the cursor. Use the numeric keys or the knob to input the gateway address.

The setting is saved to the non-volatile memory. If "Power-on" is set to "Last", and the next you power on the instrument, set both "DHCP" and "AutoIP" to "OFF", in this case, the instrument will automatically load the set gateway address.

- **Set DNS**

In the manual IP mode, you need to acquire an available DNS address from the administrator, and then configure the DNS address manually. The format of the DNS address is "nnn.nnn.nnn.nnn". The range for the first segment (nnn) of the address is from 1 to 223 (except 127); and the range for the other three segments is from 0 to 255.

In the manual IP mode, press the Up/Down arrow key to switch the parameter focus to "DNS", and then press the Left/Right arrow key to move the cursor. Use the numeric keys or the knob (fine-tune) to input the DNS address.

The setting is saved to the non-volatile memory. If "Power-on" is set to "Last", and the next you power on the instrument, set both "DHCP" and "AutoIP" to "OFF", in this case, the instrument will automatically load the set DNS address.

Tip

The three IP configuration modes cannot be all set to "ON" or "OFF".

3. Physical Address

Physical address is also called media access control address (MAC address). It is also called hardware address, which can be used to define the location of the network device. The physical address for one device is unique and is not allowed

to be modified. It can be used to identify the instrument when you assign the IP address to the instrument. A physical address is a 48-bit (6-byte) addressing scheme, usually represented in Hex. For example, 00-2A-A0-A5-E0-56.

4. VISA

VISA (Virtual Instrument Software Architecture), developed by NI (National Instrument), provides an advanced programming interface to communicate with various instruments through their bus lines. VISA enables you to communicate with the instrument in the same way, without considering the interface type of the instrument (such as GPIB, USB, LAN/Ethernet, or RS232). The instruments that communicate with the PC via GPIB, USB, LAN/Ethernet, or RS232 are called "Resources".

VISA indicates the resource name, which describes the name and location of the resource. For example, when you use the LAN interface to communicate with the instrument, the VISA descriptor is displayed as "TCPIP::172.16.3.100::INSTR".

5. Apply

Press **Apply**, and then the currently set network parameters will take effect.

Note: After you configure the network parameters, you must press **Apply** to apply the currently set network parameters, and then the new settings will take effect.

System Info

Press **Utility** to enter the system utility function interface. Then, press **System Info** to enter the system information tab, as shown in Figure 2-58.

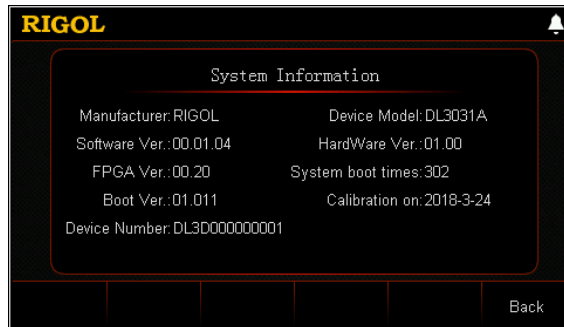

Figure 2-58 System Information Tab Interface

In the interface, you can view the system information of the instrument, including manufacturer, device model, software and hardware versions, FPGA version, boot version, system boot times, calibration date, and product serial number.

Reset

Press **Utility** to enter the system utility function interface. Then, press **Reset**. A prompt message is shown in Figure 2-59, informing you that whether to restore all the instrument settings to defaults. The factory defaults are displayed in Table 2-3.



Figure 2-59 "Reset" Dialog Box

Table 2-3 Factory Defaults

Channel Parameter	
CC	
Current	0 A
Range	6 A
Slew Rate	0.001 A/ μ s

Starting Voltage (Von)	0 V
V_Limit	155 V
C_Limit	70 A
CV	
Voltage	0 V
Range	150 V
V_Limit	155 V
C_Limit	70 A
CR	
Resistance	2 Ω
Range	15 k Ω
Starting Voltage (Von)	0 V
V_Limit	155 V
C_Limit	70 A
CP	
Power	0 W
V_Limit	155 V
C_Limit	70 A
Con	
Range	6 A
A_Level	4 A
B_Level	1 A
Rising Slew Rate	0.001 A/ μ s
Falling Slew Rate	0.001 A/ μ s
Frequency	1 kHz
Duty	50%
Trigger Source	TRAN
Pul	
Range	6 A
A_Level	4 A
B_Level	1 A
Rising Slew Rate	0.001 A/ μ s
Falling Slew Rate	0.001 A/ μ s
Width	2 s
Trigger Source	TRAN
Tog	
Range	6 A
A_Level	4 A
B_Level	1 A
Rising Slew Rate	0.001 A/ μ s

Falling Slew Rate	0.001 A/ μ s
Trigger Source	TRAN
List	
Mode	CC
Range	6 A
Circles	1
Steps	2
End State	Off
Trigger Source	TRAN
Step Value	2 A
Step Duration	1 s
Step Slew	0.001 A/ μ s
Battery	
Current	0 A
Range	60 A
Cut-off Voltage	OFF, 0 V
Battery Capacity	OFF, 0 mAh
Discharge Time	OFF, 0 s
Starting Voltage (Von)	0.5 V
OCP	
Range	60 A
Starting Voltage (Von)	0.01 V
Delay Time	500 ms
Original Current	0 A
Step Current	1 A
Step Delay	500 ms
Protection Voltage	0.5 V
Maximum Current	10 A
Minimum Current	9 A
Protection Time	500 μ s
OPP	
Starting Voltage (Von)	0.01V
Delay Time	500 ms
Starting Power	0 W
Step Power	1 W
Step Delay	500 ms
Protection Voltage	0.5 V
Maximum Power	100 W
Minimum Power	90 W
Protection Time	500 μ s

Factory	
Mode	CC
Current	0 A
Range	60 A
Maximum Value	10 A
Minimum Value	9 A
Pass_Tip	ON
Fail_Tip	OFF
Pass_Sound	ON
Fail_Sound	OFF
CC+CV	
Current	0 A
Current Range	60 A
Voltage	0 V
Voltage Range	150 V
V_Limit	155 V
C_Limit	70 A

System Setting	
Language*	简体中文
Power-on	Default
Beeper	ON
Digital Input	Disable
Digital Output	Disable
Brightness*	50%
Sense	OFF
Log	OFF
Vmon_EXT	OFF
Imon_EXT	OFF
SHORT	HOLD
Von Latch	ON

Communication Interface Setting	
 GPIB Address	2
RS232*	
Baud Rate	9600
Data Bits	8
Stop Bits	1
Parity	NONE
Flow	OFF

LAN*	
DHCP	ON
AutoIP	ON
ManualIP	OFF

Store	
Cursor	Contents
Contents	C:\
File	First File

Note*: These parameters will not be affected by the default setting operations. (Press **Utility** → **System** → **Power-on** to select "Default", and then when you power on the instrument the next time, it will restore to its factory default settings.)

Option Configuration

DL3000 series electronic load provides the following options:

- LAN: Connect the load to the PC or the local area network (LAN) where the PC resides to realize remote control.
- Digital I/O: provides the trigger input and output function.
- High Readback Resolution: improves the resolution of the instrument. The readback accuracy improves from 0.001 to 0.0001.
- High Frequency: provides the high frequency option. The slew rate increases from 3 A/μs to 5 A/μs.
- High SlewRate: provides the high slew rate option. The frequency increases from 15 kHz to 30 kHz.

If you need any of these options, order them according to the Order No. available in "**Appendix A: Order Information**", and then install the options according to this section.

Press **Utility** to enter the system utility function interface. Then, press **Option** to enter the option tab, as shown in Figure 2-60.

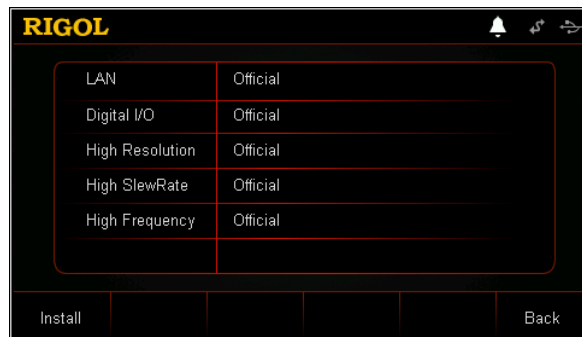

Figure 2-60 System Option Tab

In the system option tab, you can view the installation status of all options (Official, Trial, Not Installed) and install the options.

To install an option, you need an option license (each instrument has a unique license). The option license code is a 28-character string, which consists of English letters and numbers. After you purchase an option, you will obtain a key (used for obtaining the option license code). Then, you can install the license according to the following steps.

1. Obtain an option license

- (1) Log in to the **RIGOL** official website (www.rigol.com), click **SERVICE** → **Software License Register** to enter the "Registered product license code" interface.

- (2) In the interface, enter the correct key, serial number (press **Utility**, and then press **System Info** to enter the system information tab to obtain the serial number of the instrument), and verification code. Then click **Generate** to obtain the option license.

Note: The hyphens in the option license should be omitted.

2. Install the option

Method 1: Front Panel Operations

- (1) Click the "Option" tab to enter the option interface, press **Install** to enter the License Input interface, as shown in the following figure.

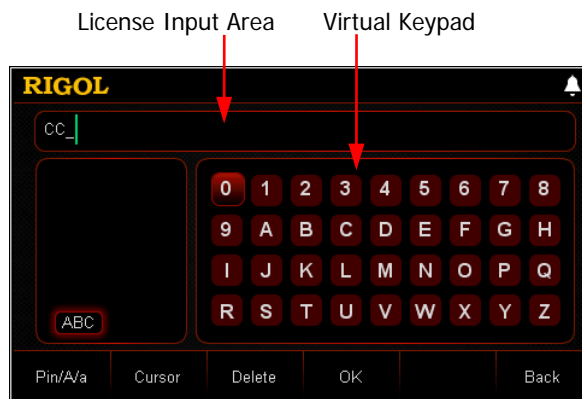



Figure 2-61 License Input Interface

- (2) In the License Input interface, press the arrow keys or use the knob to select the desired characters (the English letter is not case-sensitive) on the virtual keypad, and then press **OK** to enter the characters. The entered characters will be displayed in the "License Input Area". While inputting the license, you can continuously press **Delete** or the Backspace key  to delete the unnecessary letters that have been input.

Note: The hyphens in the option license should be omitted.

- (3) After inputting a license, press **OK** to complete the operation.

Tip

If you want to quit the installation operation, press **Back** to give up installing the option and exit the installation interface.

Method 2: Read the option installation files from the USB storage device

The contents and format requirement for the option installation file are as follows:

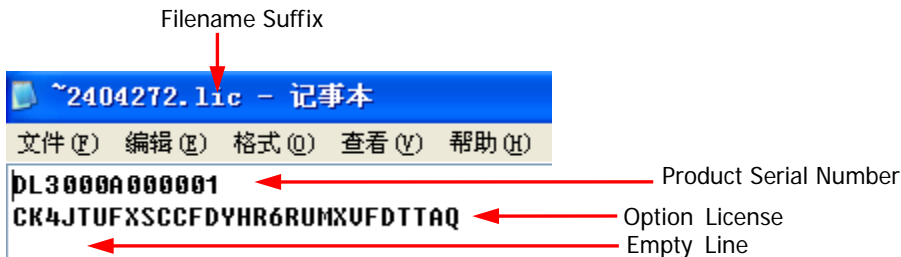

- The filename suffix must be ".lic".
- Contents requirement:
 - Line 1: product serial number (Press **Utility** → **System** to obtain the product serial number);
 - Line 2: option license code;
 - Line 3: empty line (cannot be omitted)

Note: The hyphens in the option license should be omitted.

Option Installation Procedures:

- Edit the option installation file that meets the above requirements and save it to the USB storage device.
- Power on the instrument and insert the USB storage device. Press **Store** on the front panel of the load to enter the storage and recall interface.
- In the storage and recall interface, refer to "Store and Recall" to complete reading the option installation file according to the following step.
 - Select "D:" → select the specified file → press **Read**.

Method 3: Send SCPI Commands

To open remote control window and send the option installation command :LIC:SET <license>, refer to "Remote Control".
Wherein, <license> is the option license code, and the hyphens in the code should be omitted.
For example, :LIC:SET UVF2L3N3XXKYTB73PPRSA4XDMSRT

If the option has been successfully installed, a prompt message will be displayed; otherwise, a message indicating a failed installation will be displayed.

Chapter 3 Remote Control

You can adopt the following two ways to remotely control the electronic load.

User-defined programming

Users can program and control the instrument by using the SCPI (Standard Commands for Programmable Instruments) commands. For details about the SCPI commands and programming, refer to *DL3000 Programming Guide*.

Operation Procedures:

- (1) Set up communication between the instrument and PC.
- (2) Send commands by programming in LabVIEW, MATLAB, etc.

PC software

Users can use the PC software to send commands to control the instrument remotely. **RIGOL** Ultra Sigma is recommended. You can download the software from **RIGOL** official website (www.rigol.com).

Operation Procedures:

- (1) Set up communication between the instrument and PC.
- (2) Run Ultra Sigma and search for the instrument resource.
- (3) Open the remote command control panel to send commands.

The electronic load can communicate with the PC via the following interfaces:

- Remote Control via USB
- Remote Control via LAN
- Remote Control via GPIB
- Remote Control via RS232

This chapter will illustrate how to use the Ultra Sigma software to remotely control the load via various interfaces.



CAUTION

Before setting up communication, please turn off the instrument to avoid causing damage to the communication interfaces.

Remote Control via USB

1. Connect the load to the PC

Use the USB cable to connect the load to the PC via the USB DEVICE interface on the rear panel of the load.

2. Install the USB driver

This load is a USB-TMC device. After you connect the load to the PC properly and power it on for the first time (the load will be automatically configured with the USB interface). In this case, "Found New Hardware Wizard" dialog box appears on the PC. Please install "USB Test and Measurement Device (IVI)" according to the instructions. The steps are as follows:

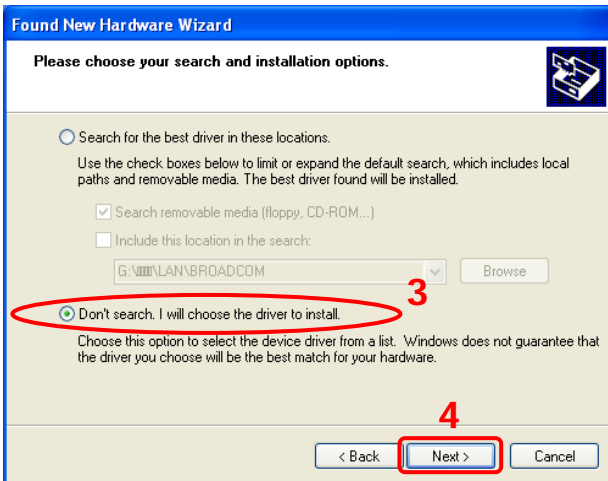
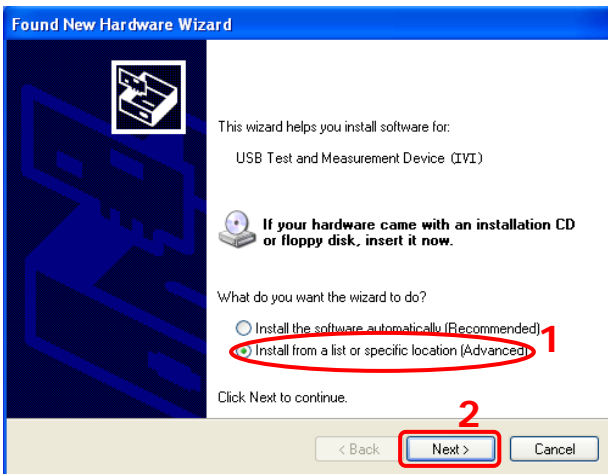

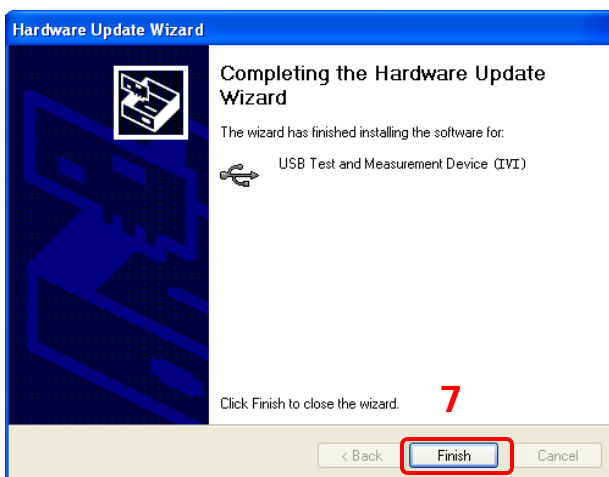
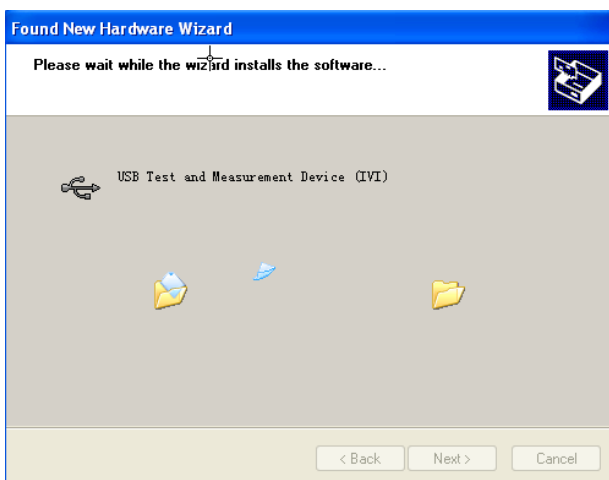
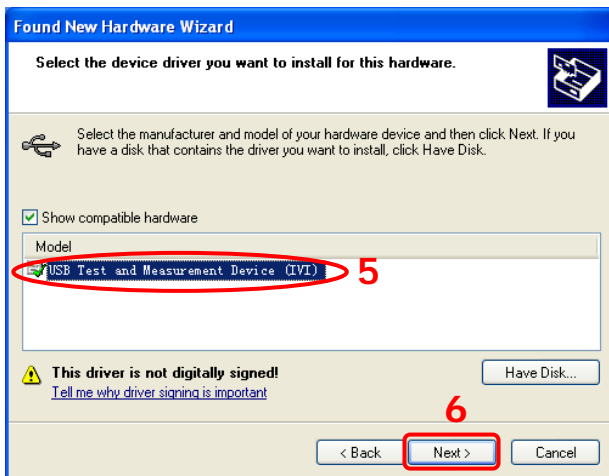

3. Search for the device resource

Start up Ultra Sigma and the software will automatically search for the resource currently connected to the PC. You can also click **USB-TMC** to search for the resource.

4. View the device resource

The searched instrument resource will be under the directory of "RIGOL Online Resource", with the model of the instrument and the USB information being displayed.



5. Control the instrument remotely

Right-click the resource name "DL3031A (USB0::0x1AB1::0x0E11::DL3000A000001::INSTR)", and select "SCPI Panel Control" to open the remote command control panel, as shown in the following figure. Then you can send commands and read data through the panel.

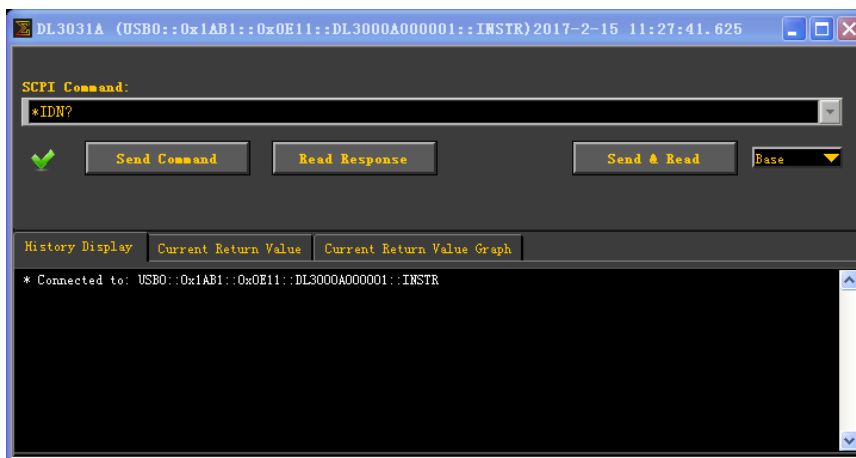

Remote Control via LAN

1. Connect the load to the PC

Use the network cable to connect the load to the PC or the local area network (LAN) where the PC resides.

2. Configure network parameters

1) DHCP mode:

If the network supports DHCP, the DHCP server in the network assigns network parameters (IP Address, Subnet Mask, Gateway and DNS) for the load automatically.

2) Auto IP mode:

The load will automatically select the auto IP mode when any of the following three conditions occur: 1) the network doesn't support DHCP; 2) DHCP mode of the load is disabled; 3) the load is connected to the PC directly. After selecting the auto IP mode, it will acquire the IP address ranging from "169.254.0.1" to "169.254.255.254" and subnet mask 255.255.0.0 automatically.

3) Manual IP mode:

Enable the Manual IP mode and disable the DHCP mode as well as the Auto IP mode to set the network parameters manually.

If the load is connected to the PC directly, set the IP Addresses, Subnet Masks and Gateways for both of the PC and the load. The Subnet Masks and Gateways of the load and PC must be the same and their IP Addresses must be within the same network segment (for details, refer to the TCP/IP protocol). An example is shown in the table below.

Network Parameters	PC	Load
IP Address	192.16.3.3	192.16.3.8
Subnet mask	255.255.255.0	255.255.255.0
Default gateway	192.16.3.1	192.16.3.1

If the load is connected to the local network area where the PC resides, please acquire a set of valid network parameters from the administrator and configure the network parameters of the load according to the descriptions in "**Set the parameters for the LAN interface**".

3. Search for the device resource

Start Ultra Sigma, and then click **LAN**. A window is displayed as shown in Figure (a). Click **Search** and the software searches for the instrument resource currently connected to the PC or the LAN where the PC resides. The

resource found is displayed at the right of the window as shown in Figure (b). Click **OK** to add it.

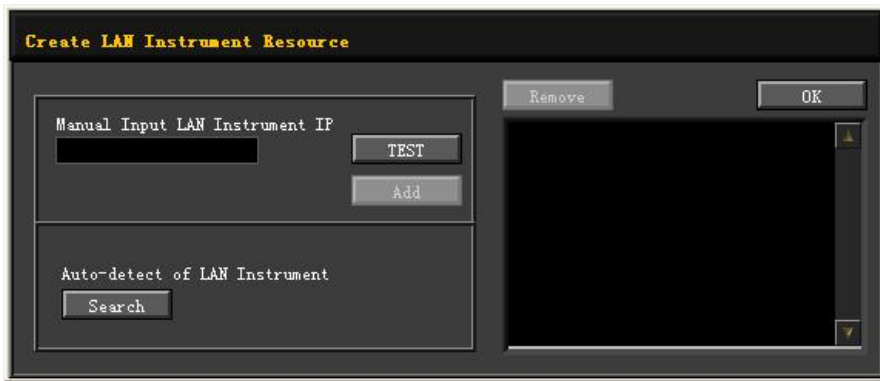

(a)

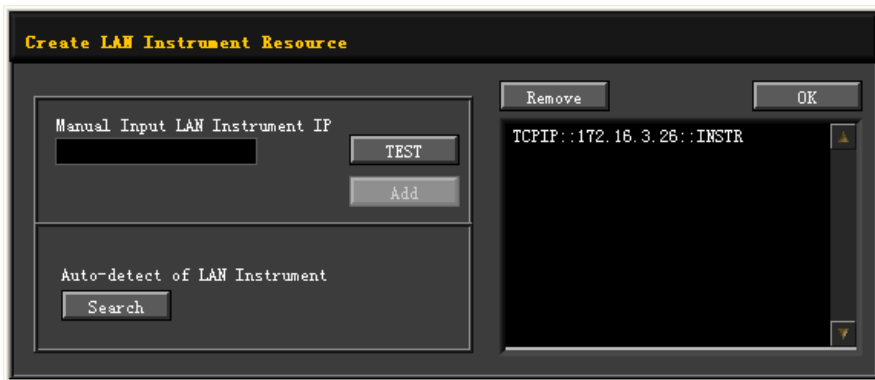

(b)

Note: If you want to remove the resource, select the resource and then click **Remove** to remove it.

4. View the device resource

The searched instrument resource will be under the directory of "RIGOL Online Resource", as shown in the following figure.



5. Control the instrument remotely

Right-click the resource name "DL3031A (TCPIP::172.16.3.93::INSTR)", and select "SCPI Panel Control" to open the remote command control panel, as shown in the following figure. Then you can send commands and read data through the panel.

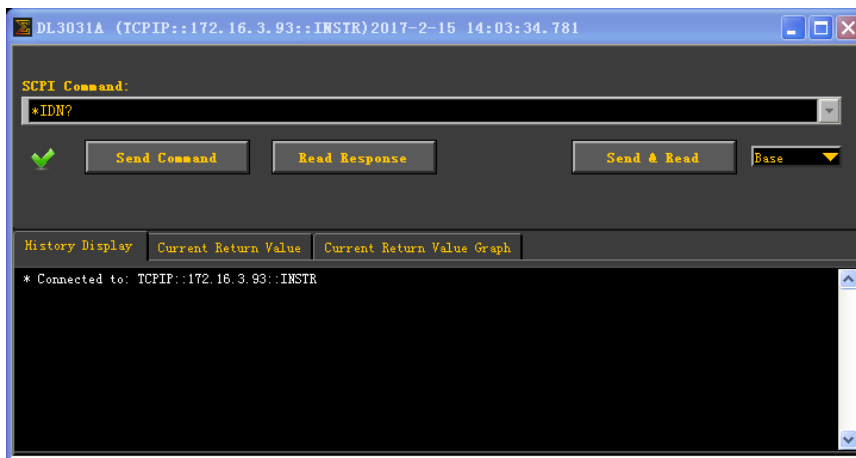

6. Load LXI webpage

The load conforms to LXI Core 2011 Device standard. You can load LXI webpage through Ultra Sigma (right-click the resource name and select LXI-Web; or directly input the IP address in the browser). Various important information about the instrument (including the model, manufacturer, serial number, description, MAC address, and IP address) will be displayed on the webpage.

Remote Control via GPIB

1. Connect the load to the PC

Use the USB-GPIB interface converter to extend the GPIB interface for the load, and then use the GPIB cable to connect the load to the PC to realize remote control.

2. Install the driver of GPIB card

Correctly install the driver of the GPIB card which has been connected to the PC.

3. Set the GPIB address

Set the GPIB address of the load according to the description in "Set the GPIB address".

4. Search for the device resource

Start Ultra Sigma, and then click **GPIB**. A window is displayed as shown in Figure (a). Click **Search** and the software searches for the instrument resource currently connected to the PC via the GPIB interface. The resource found is displayed at the right of the window as shown in Figure (b). Click **OK** to add it.

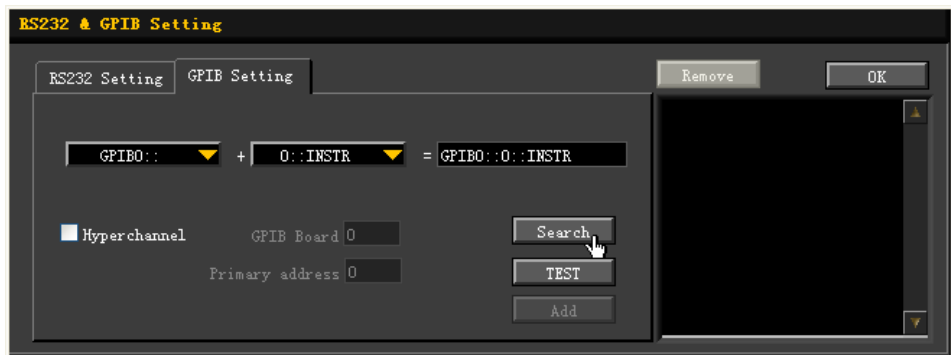

(a)



(b)

Note: If you want to remove the resource, select the resource and then click **Remove** to remove it.

If the resource cannot be searched automatically:

- Select the GPIB card address of the PC from the drop-down box of "GPIB0::" and select the GPIB address set in the load from the drop-down box of "0::INSTR".
- Click **TEST** to check whether the GPIB communication works normally; if not, please follow the corresponding prompt messages to handle it.

5. View the device resource

The searched instrument resource will be under the directory of "RIGOL Online Resource", as shown in the following figure.



6. Control the instrument remotely

Right-click the resource name "DL3031A (GPIB0::2::INSTR)", and select "SCPI Panel Control" to open the remote command control panel, as shown in the following figure. Then you can send commands and read data through the panel.

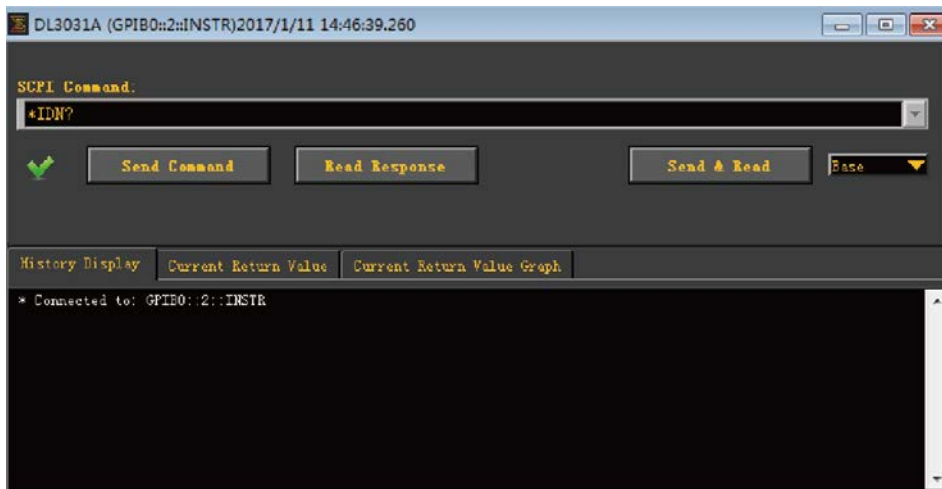

Remote Control via RS232

1. Connect the load to the PC

Use the 9-pin RS232 cable (female-to-female, cross-over) to connect the load with the PC via the RS232 interface on the rear panel of the load.

2. Set the parameters for the RS232 interface

Set the parameters of the RS232 interface according to the descriptions in "Set the parameters for the RS232 interface".

3. Add the device resource

Start Ultra Sigma, and then click . A window is displayed as shown in Figure (a).

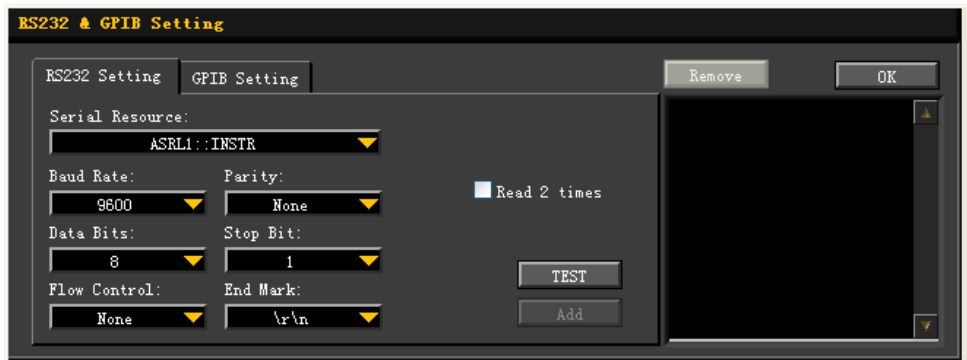

(a)

In the "RS232 Setting" tab, set Baud Rate, Parity, Data Bits, and Stop Bit that match the current parameters of the RS232 interface of the instrument (**Note:** You must select "None" under the "Flow Control" option, and select "\r\n" under the "End Mark" option). After that, click "TEST". If the test passes, a dialog box is displayed, as shown in Figure (b).

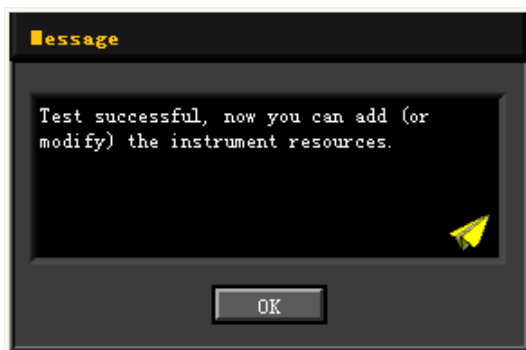

(b)

Note: If the test fails, check whether the instrument can communicate with the PC via the RS232 cable normally, whether the current RS232 settings of the Ultra

Sigma software match those of the RS232 interface of the instrument. In the dialog box shown in Figure (b), click **OK**. Then the "Add" button in the "RS232 Setting" tab will be enabled. Click **Add**, and then the currently selected instrument resource will be displayed at the right section of the window, as shown in Figure (c). Then, click **OK** to add the instrument resource.



(c)

4. View the device resource

The searched instrument resource will be under the directory of "RIGOL Online Resource", as shown in the following figure.



5. Control the instrument remotely

Right-click the resource name "DL3031A (ASRL1::INSTR)", and select "SCPI Panel Control" to open the remote command control panel, as shown in the following figure. Then you can send commands and read data through the panel.

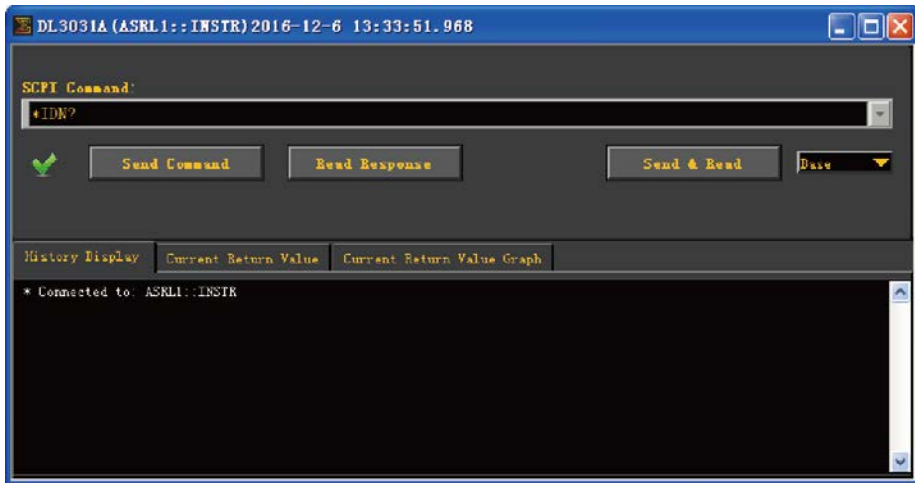

Chapter 4 Troubleshooting



WARNING

Do not disassemble the instrument by yourself. Otherwise, you might be exposed to the danger of electric shock. Any maintenance, adjustment or replacement especially to circuits or accessories must be performed by **RIGOL** authorized personnel.



WARNING

Only the exclusive power cord designed for the instrument and authorized for use within the local country could be used. For replacement of the power cord, please contact **RIGOL**.

This chapter lists the potential problems or failure, as well as the solutions in using the instrument. If the following problems occur, locate and resolve the problems according to the following steps. If the problems still persist, contact **RIGOL** and provide your instrument information to us. (For instrument information, press **Utility** → **System**.)

1. The instrument cannot be powered on.

- (1) Check whether the power cord is correctly connected.
- (2) Check whether you have pressed down the Power key on the front panel.
- (3) Plug out the power cord, and check whether the voltage selector is in the proper position, whether the fuse conforms to the fuse rating, and whether the fuse is intact. For fuse replacement, refer to "Fuse Replacement".
- (4) If the problem still persists, contact **RIGOL**.

2. An exception occurs when the load sinks the current in CC mode.

- (1) Check whether the cable that connects the instrument to the DUT is reversely connected, which causes the instrument to report the alarm for reverse connection.
- (2) Check whether the input power calculated based on the input voltage and the current that the load sinks exceeds the power limit of the instrument, thus resulting in overpower protection.
- (3) Check whether the range of the load current is properly set.
- (4) If the problem still persists, contact **RIGOL**.

3. An exception occurs to the input in CV mode.

- (1) Check whether the cable that connects the instrument to the DUT is reversely connected, which causes the instrument to report the alarm for reverse connection.
- (2) Check whether the maximum output voltage of the DUT is smaller than the set load voltage.
- (3) Check whether the DUT works normally.

(4) If the problem still persists, contact **RIGOL**.

4. An exception occurs to the input in CR mode.

- (1) Check whether the output of the DUT is normal, e.g. check whether an oscillation occurs to the DUT.
- (2) Check whether the range for the resistance is properly set.
- (3) If the problem still persists, contact **RIGOL**.

5. An exception occurs to the input in CP mode.

- (1) Check whether the cable that connects the instrument to the DUT is reversely connected, which causes the instrument to report the alarm for reverse connection.
- (2) Check whether the output of the DUT is normal, e.g. check whether an oscillation occurs to the power supply; whether the rated power of the power supply fails to reach the set power of the load.
- (3) If the problem still persists, contact **RIGOL**.

6. An exception occurs to the transient feature test in CC mode.

- (1) Check whether the cable that connects the instrument to the DUT is reversely connected, which causes the instrument to report the alarm for reverse connection.
- (2) Make a real-time measurement for the CC slew rate. If the value failed to reach the standard, shorten the leads between the DUT and the instrument as much as possible, because the long leads will result in a slow slew rate.
- (3) Check whether the range of the load current is properly set.
- (4) If the problem still persists, contact **RIGOL**.

7. The USB storage device cannot be recognized.

- (1) Check whether the USB storage device can work normally.
- (2) Make sure the USB storage device used is FAT32-format Flash storage type, as this instrument does not support hardware storage type USB storage device.
- (3) Restart the instrument and insert the USB storage device to check it.
- (4) If the USB storage device still cannot work normally, please contact **RIGOL**.

Chapter 5 Appendix

Appendix A: Order Information

	Description	Order No.
Model	Programmable DC Electronic Load (single channel, DC 150 V/40 A 200 W 15 kHz 2.5 A/μs)	DL3021
	Programmable DC Electronic Load (single channel, DC 150 V/40 A 200 W 30 kHz 3.0 A/μs)	DL3021A
	Programmable DC Electronic Load (single channel, DC 150 V/60 A 350 W 15 kHz 2.5 A/μs)	DL3031
	Programmable DC Electronic Load (single channel, DC 150 V/60 A 350 W 30 kHz 5.0 A/μs)	DL3031A
Standard Accessories	Power Cord	-
	Either one of the following fuses: <ul style="list-style-type: none"> ● Fuse 50T-0200H 250 V 0.20 A (AC selector: 230 Vac) ● Fuse 50T-0315H 250 V 0.315 A (AC selector: 115 Vac) 	-
	Quick Guide (hard copy)	-
	Shield	-
Software Options^[1]	LAN Interface	LAN-DL3
	Digital I/O Option	DIGITALIO-DL3
	High Readback Resolution	HIRES-DL3
	High Frequency Option	FREQ-DL3
	High Slew Rate Option	SLEWRATE-DL3
Accessories	Shield#DL3000#F	SC-DL3
	9-Pin RS232 Cable (female-to-female, cross-over)	CB-RS232-A
	USB-GPIB Interface Converter	USB-GPIB-L
	Sense Cable	CB-SENSE
	20 A Test Lead	CB-20A-780MM
	40 A Test Lead	CB-40A-780MM
	60 A Test Lead	CB-60A-780MM
	DL3000 Series Rack Mount Kit (for a single instrument)	RM-1-DP800
	DL3000 Series Rack Mount Kit (for two instruments)	RM-2-DP800

Note^[1]: The A-plus instrument models (DL3021A/DL3031A) have been installed with software options before leaving the factory.

Note:

- (1) When the DUT outputs large currents, please use the specified test leads provided in the optional accessories.
- (2) The color schemes for the interfaces of A-plus instrument models (DL3021A/DL3031A) and

those models without A (DL3021/DL3031) are different.

(3) For all the accessories and options, please contact the local office of **RIGOL**.

Accessories Description

20 A/40 A/60 A Test Lead

Model	20 A Test Lead	40 A Test Lead	60 A Test Lead
Maximum Current	20 A	40 A	60 A
Maximum Voltage	150 V	150 V	150 V
Terminal	M8/M8	M8/M8	M8/M8
Wire Gauge	AWG14	AWG14×2	AWG14×3
Length	780 mm	780 mm	780 mm
Exterior Design			

Sense Cable

Enable the Sense function. Then, use the sense cables to connect the sense terminals and the output terminals of the DUT to compensate for the voltage drop caused by the load leads.

Cable length: 780 mm



USB-GPIB Interface Converter

Use the USB-GPIB interface converter to extend the GPIB interface, and then use the GPIB cable to connect the load to the PC to build communication with the PC for remote control.



Shield

For safety considerations, a shield shall be installed.



9-Pin RS232 Cable

To realize remote control, use the 9-pin RS232 cable to build communication between the load and the PC via the RS232 interface on the rear panel of the load.



Rack Mount Kit for a single instrument

It is used for installing a single instrument.

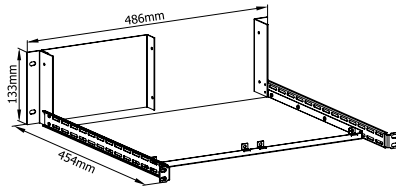

Rack Mount Kit for two instruments

It is used for installing two instruments.

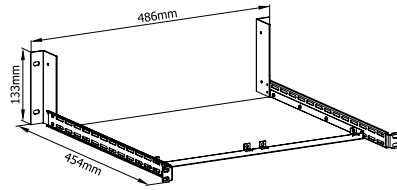

Appendix B: Warranty

RIGOL warrants that the product mainframe and product accessories will be free from defects in materials and workmanship within the warranty period. If a product proves defective within the warranty period, **RIGOL** guarantees free replacement or repair for the defective product.

To get repair service, please contact with your nearest **RIGOL** sales or service office.

There is no other warranty, expressed or implied, except such as is expressly set forth herein or other applicable warranty card. There is no implied warranty of merchantability or fitness for a particular purpose. Under no circumstances shall **RIGOL** be liable for any consequential, indirect, ensuing, or special damages for any breach of warranty in any case.

Index

AC Selector	1-10, 1-13	Local Operation Mode	2-2
Air Outlet	1-10	MAC	2-103
Battery	2-60	Minimum Transition Time	2-80
Beeper.....	2-93	OCP	2-45
Built-in Help System.....	1-17	OPP	2-53
Bus Trigger	2-80	Option Configuration	2-110
CC.....	2-3	Option Installation File	2-111
Channel Input	2-6	Option License	2-110
Con	2-18	Parameter Setting Method.....	1-18
CP.....	2-15	Pul.....	2-25
CR.....	2-11	Remote Sense.....	2-84
CV.....	2-7	RS232 Interface	2-98
Default Gateway	2-103	Save a File.....	2-88
Digital Input	2-94	Sense Connections	2-84
Digital Output.....	2-94	Sense Terminals	1-8
DNS	2-103	Sink	2-78
Factory Defaults.....	2-105	Subnet Mask.....	2-102
Factory Test	1-6, 2-65	Switch Lever	1-11
Fuse	1-15	System Info	2-105
GPIB Address	2-97	System Utility Function	2-92
Guide Interface.....	1-16	TFT.....	1-4
IP Address	2-102	Tog	2-32
IP Configuration	2-101	VISA	2-104
Key	2-110	Von.....	2-5, 2-13
Last.....	2-93	Von Latch Function.....	2-78
License	2-110	Waveform Display Function	2-73
List.....	2-1, 2-38		