

714B TC Calibrator

Quick Reference Guide

Warning

To prevent possible electrical shock, fire, or personal injury, read the "714B Safety Sheet" before you use this Product.

Go to www.fluke.com to register your product, download manuals, and find more information.

Magnetic Hanger

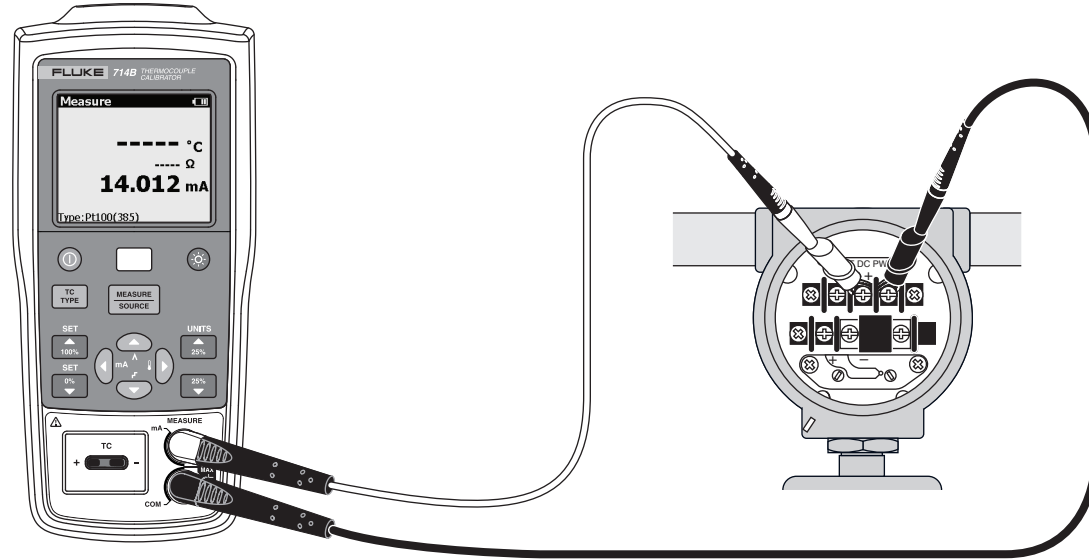
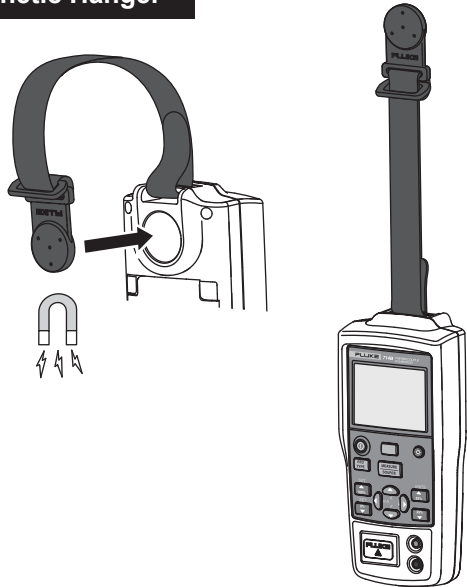

TC Type

1. TC TYPE
2. Up/Down arrow
3. TC TYPE

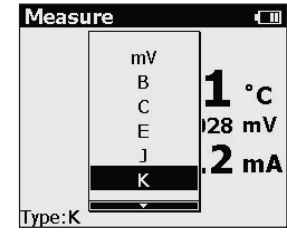

Settings

1. SHIFT
2. TC TYPE
3. Up/Down arrow
4. Right arrow (Enable/Disable)
5. TC TYPE

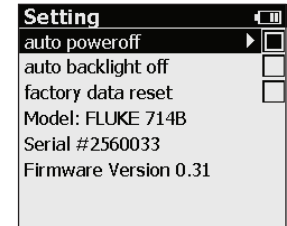

TC Measure

Temperature with TC

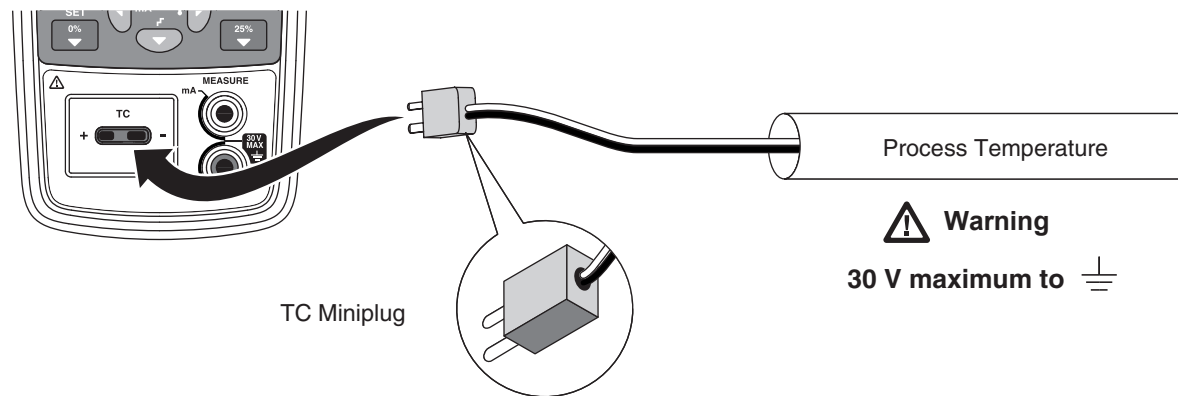

Units

1. SHIFT
2. UNITS

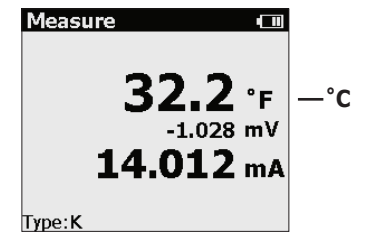

Source

Simulate Thermocouple

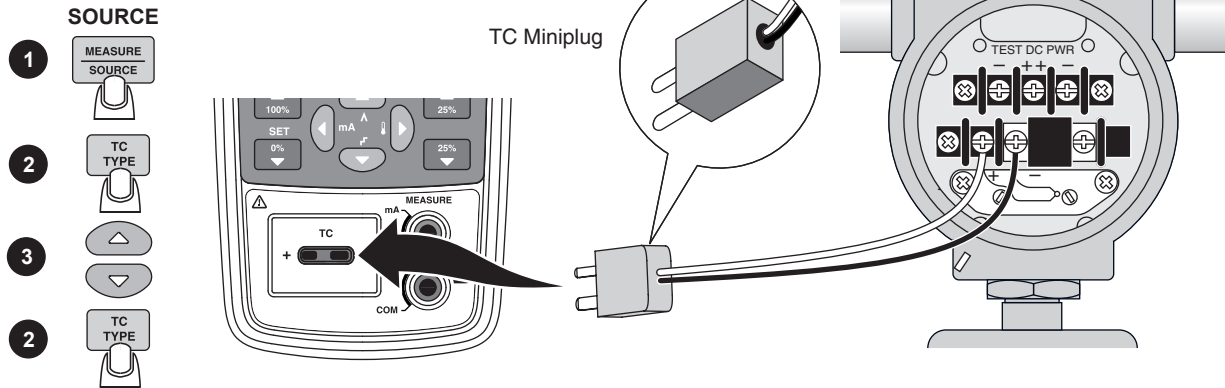

Set TC Value

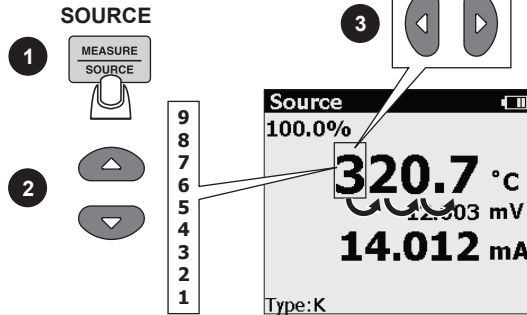

Contrast

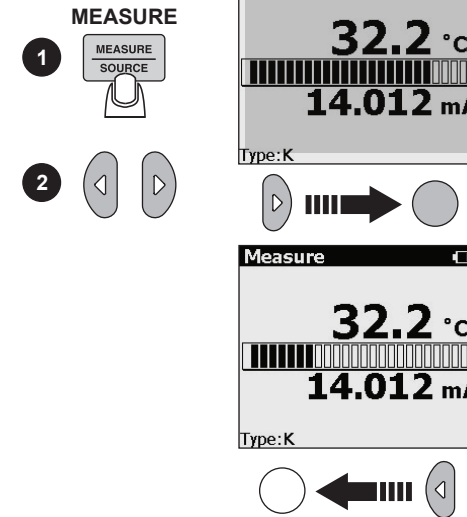

0%

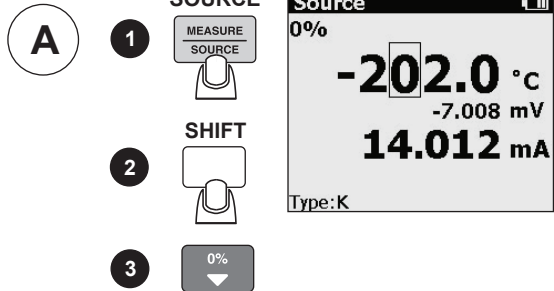

Linearity or Span Test

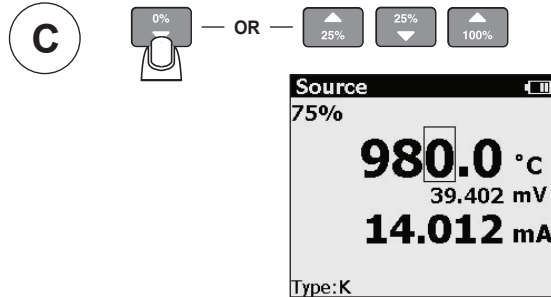

mA / °C Scale mA Channel to Temperature

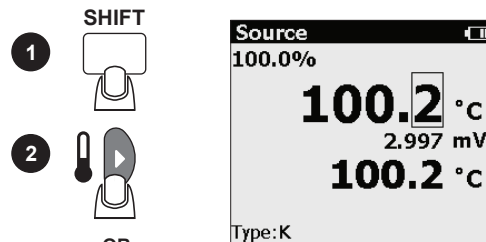

Note:

- Temperature at 4 mA =
- Span check 0 %
- Temperature at 20 mA =
- Span check 100 %

100%

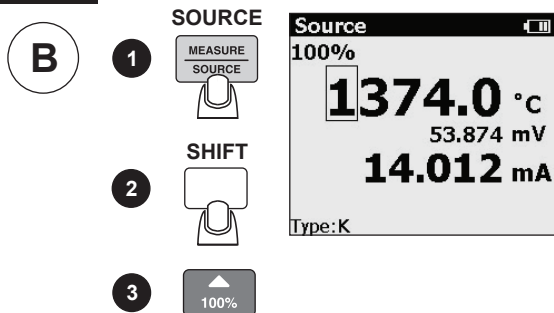

Ramp or Step

